

1

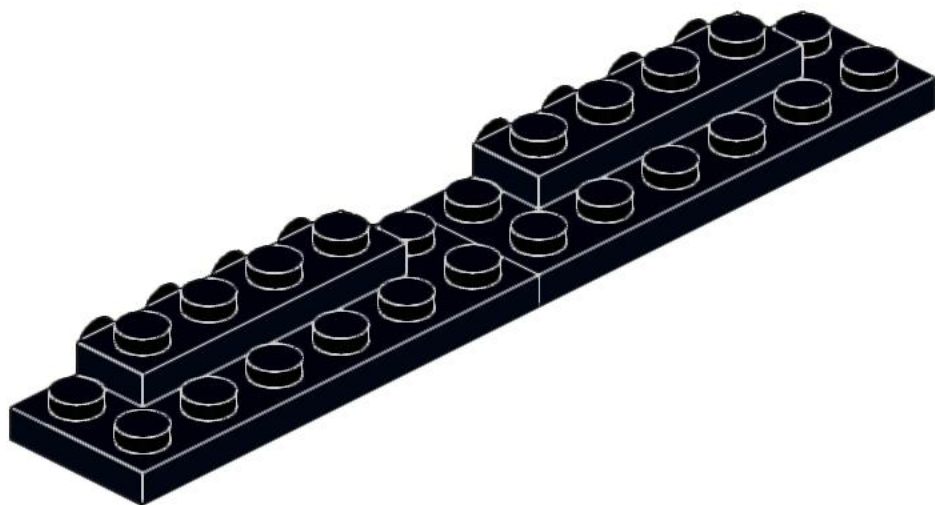

2

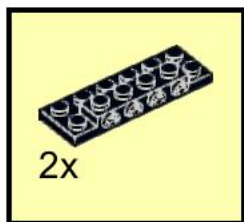
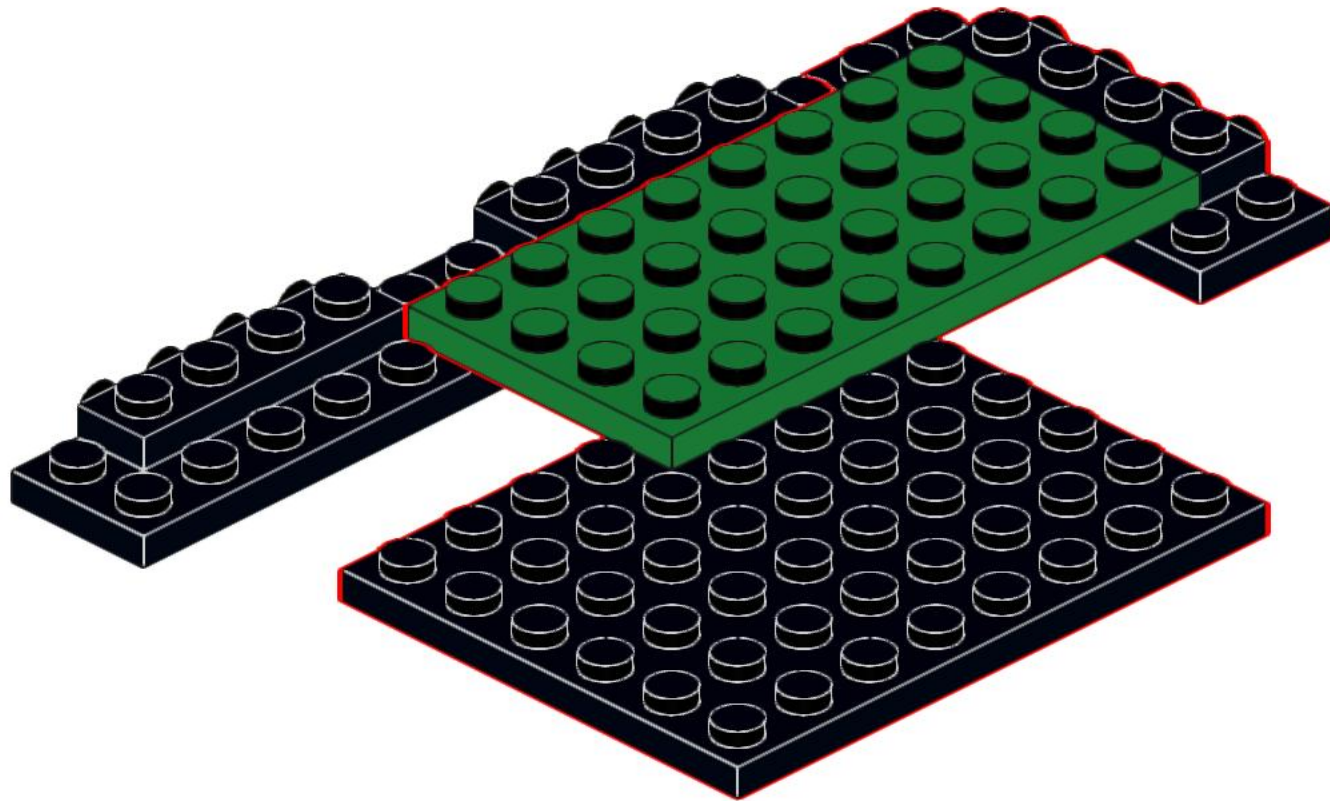
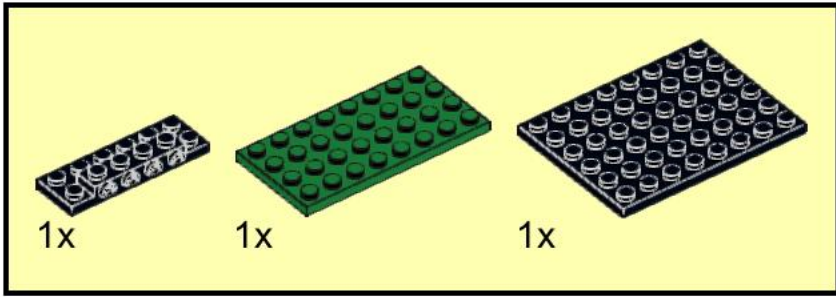

3

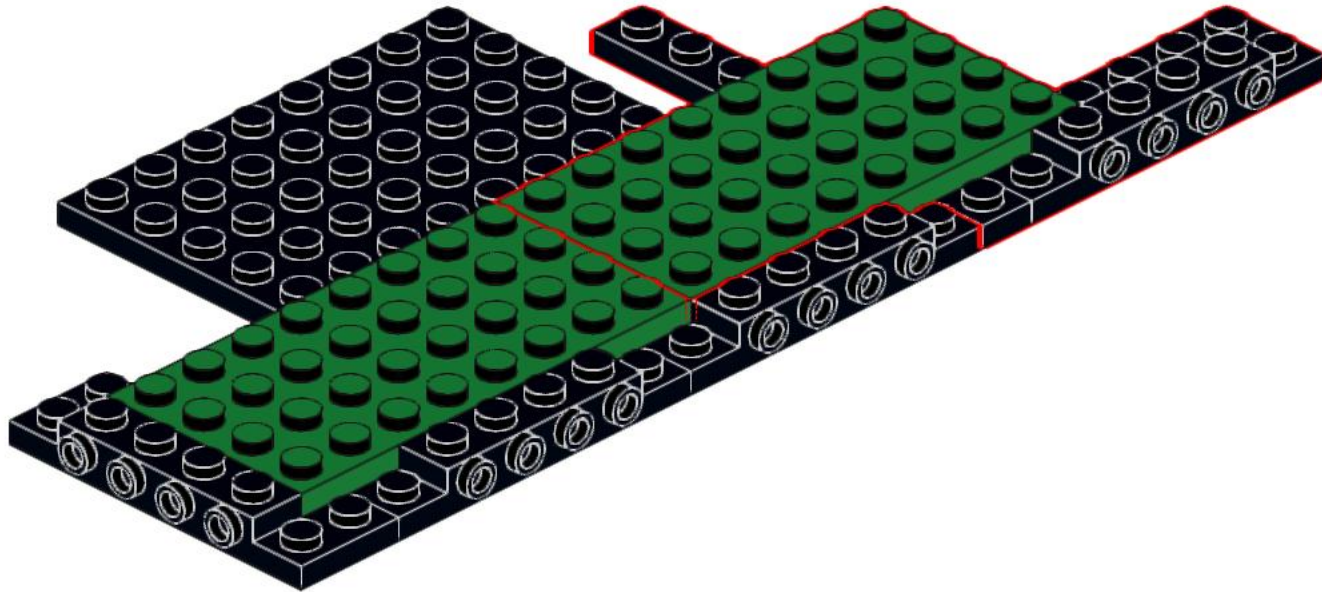
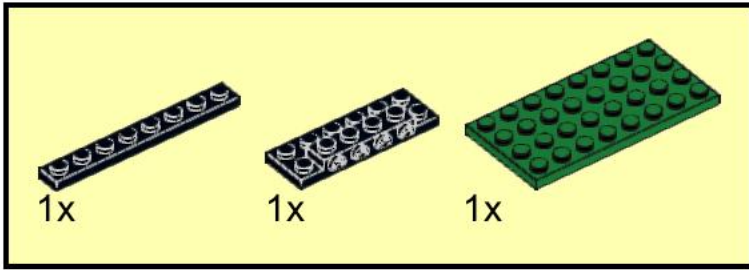

4

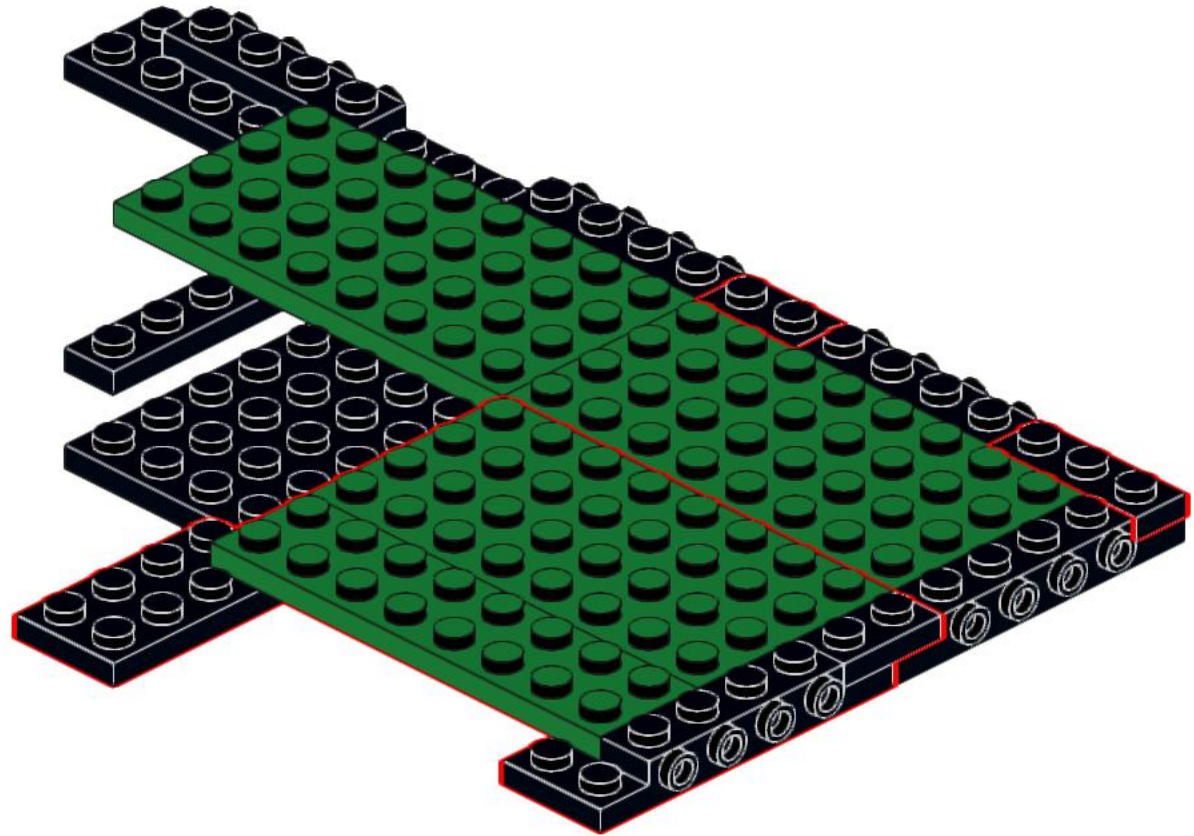
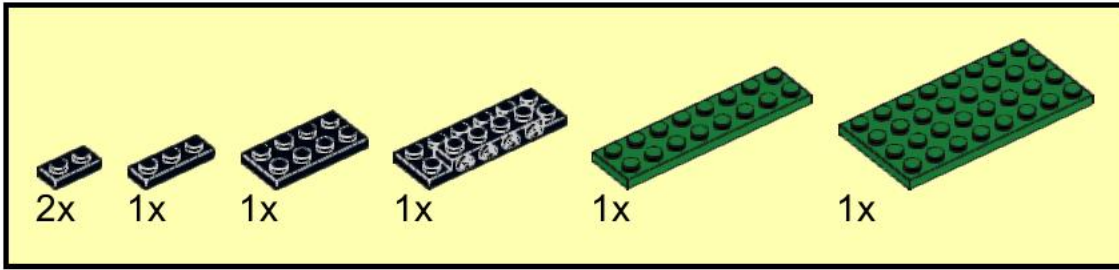

5

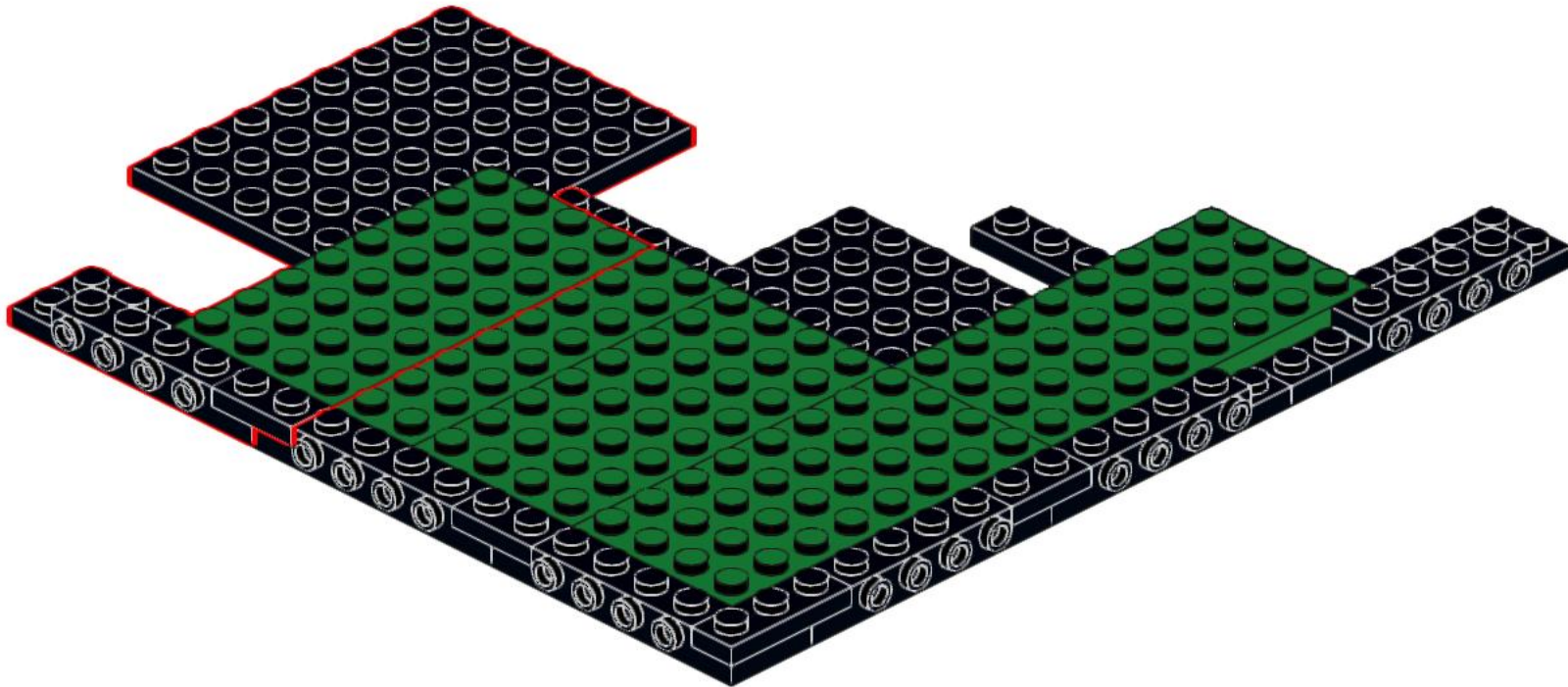
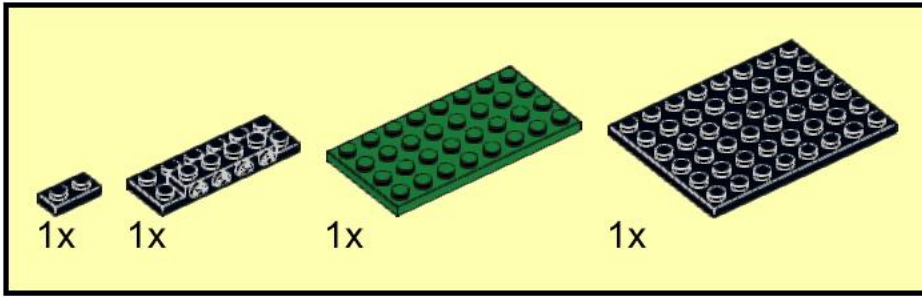

6

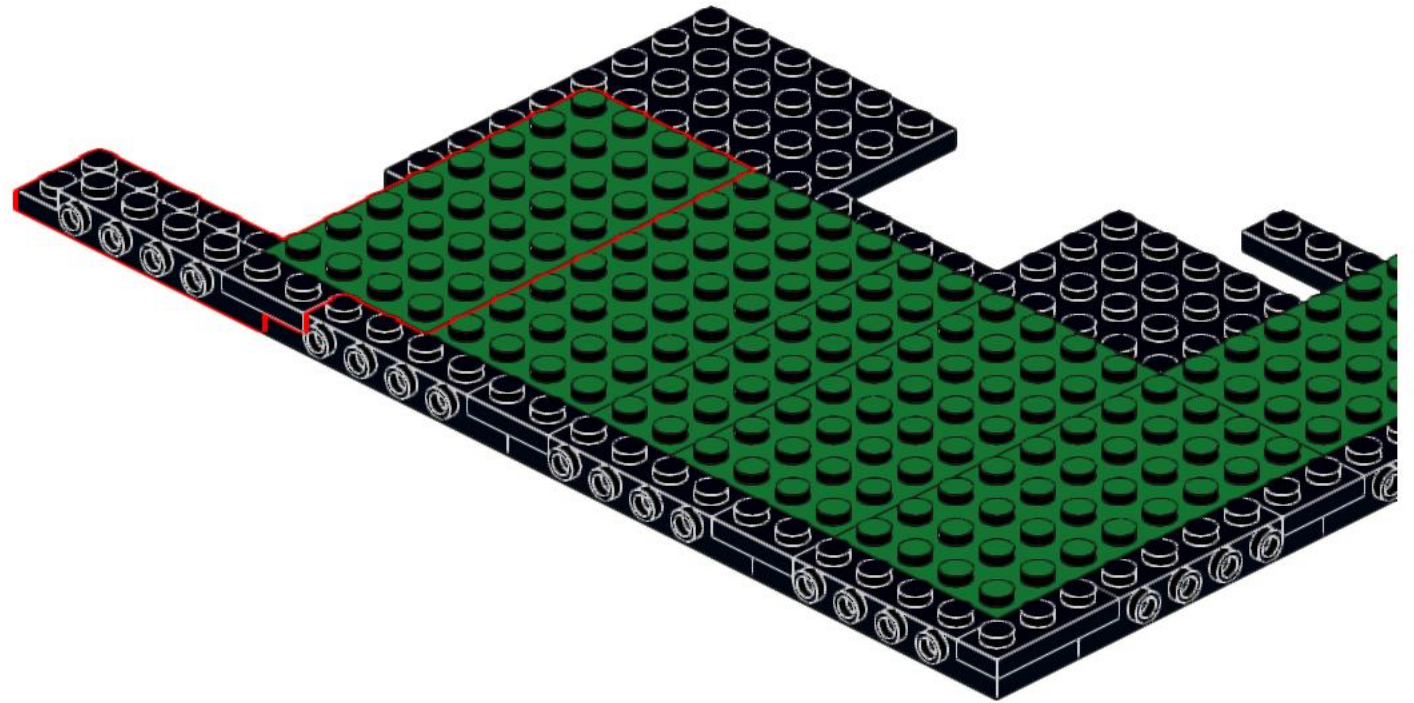
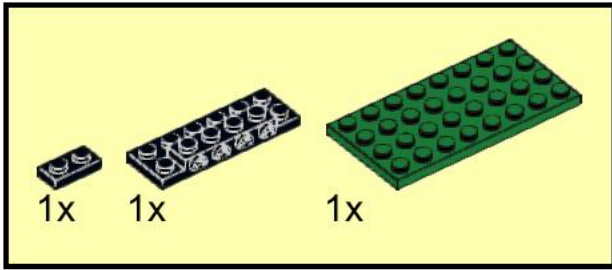

7

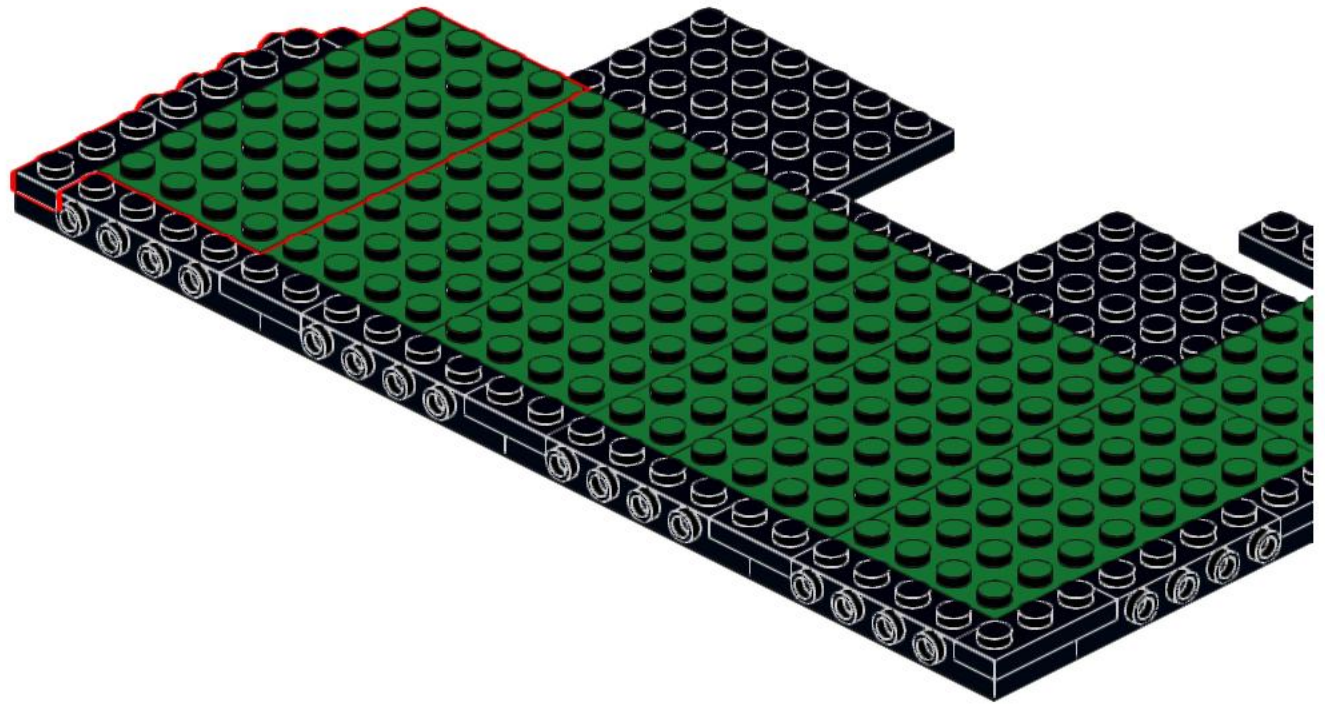
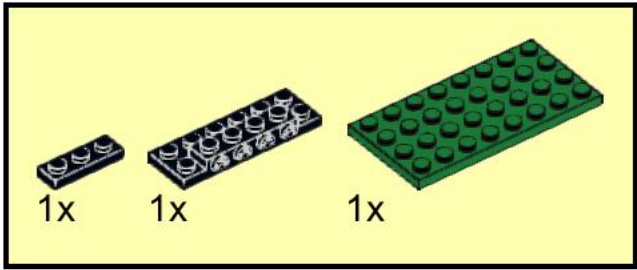

8

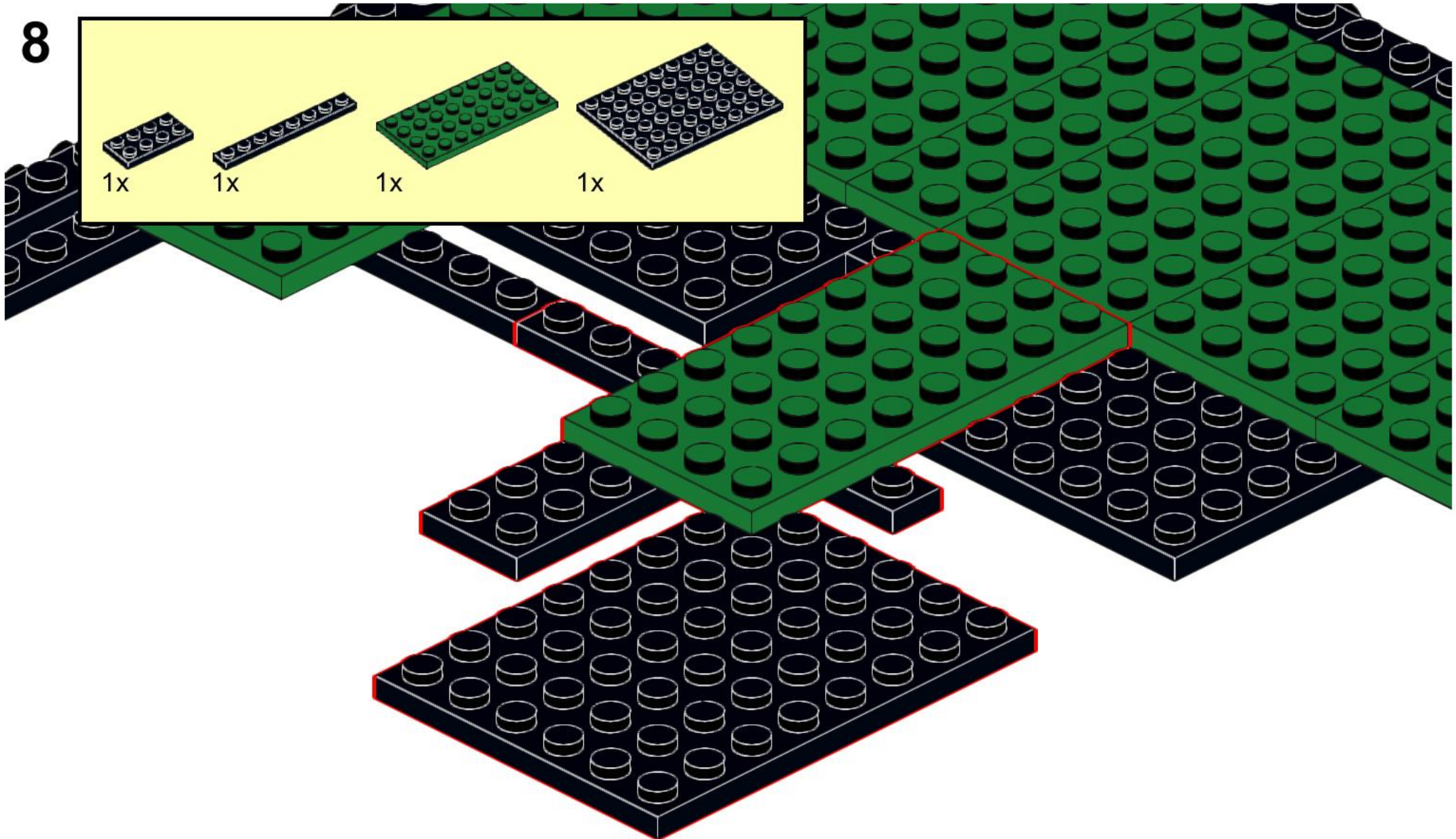
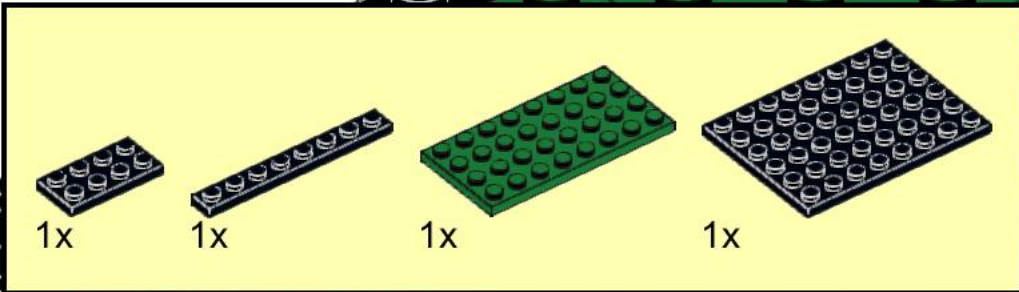

9

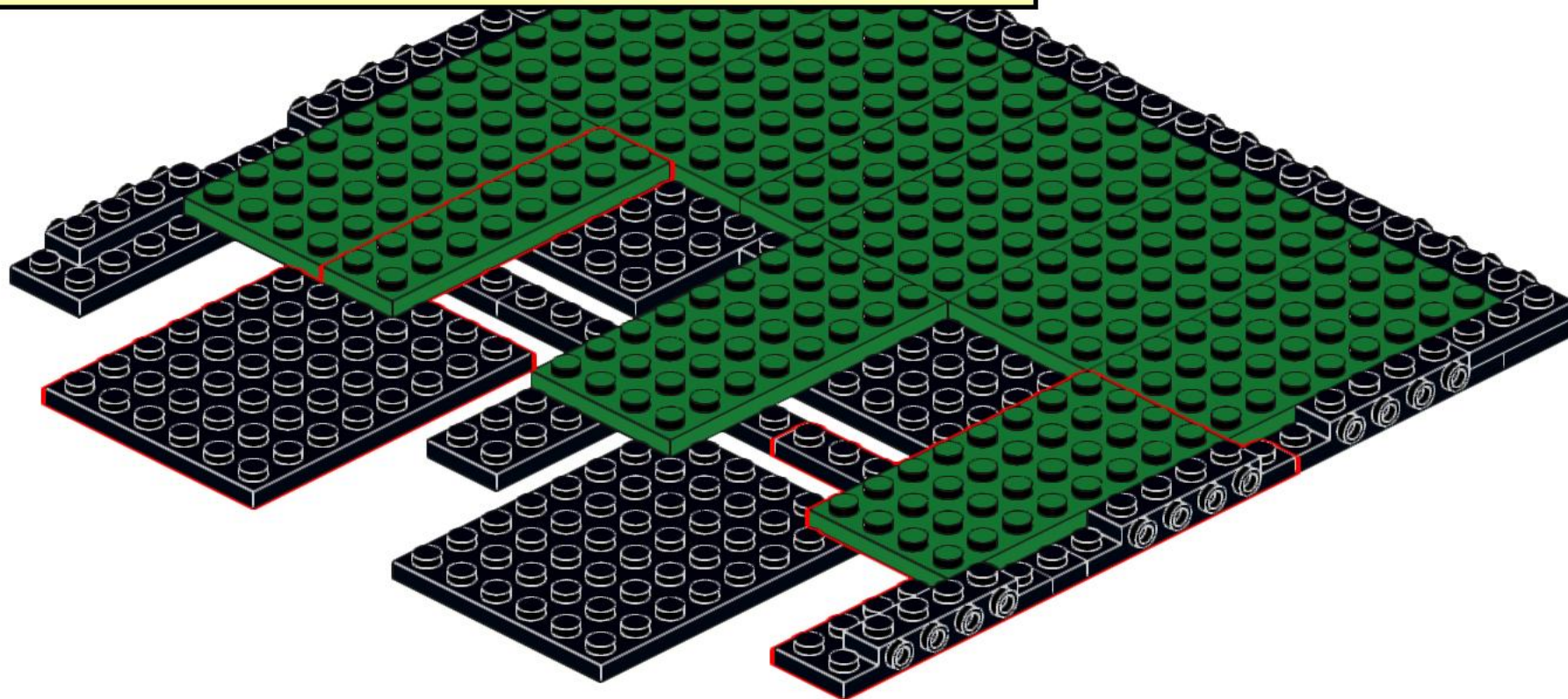
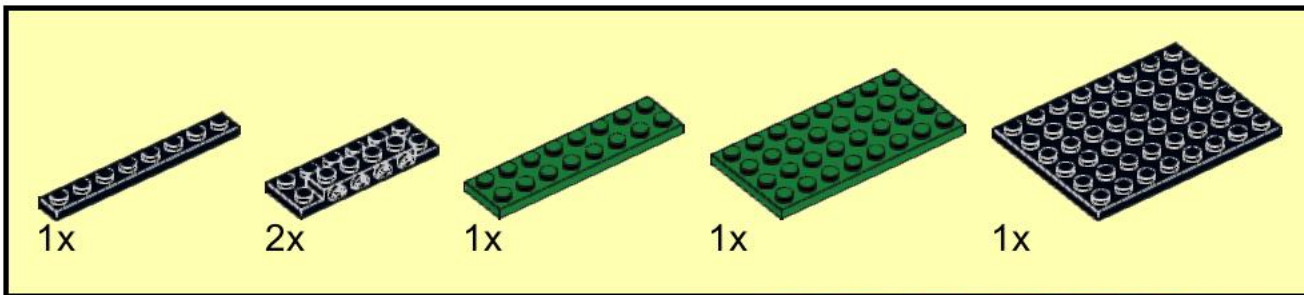

10

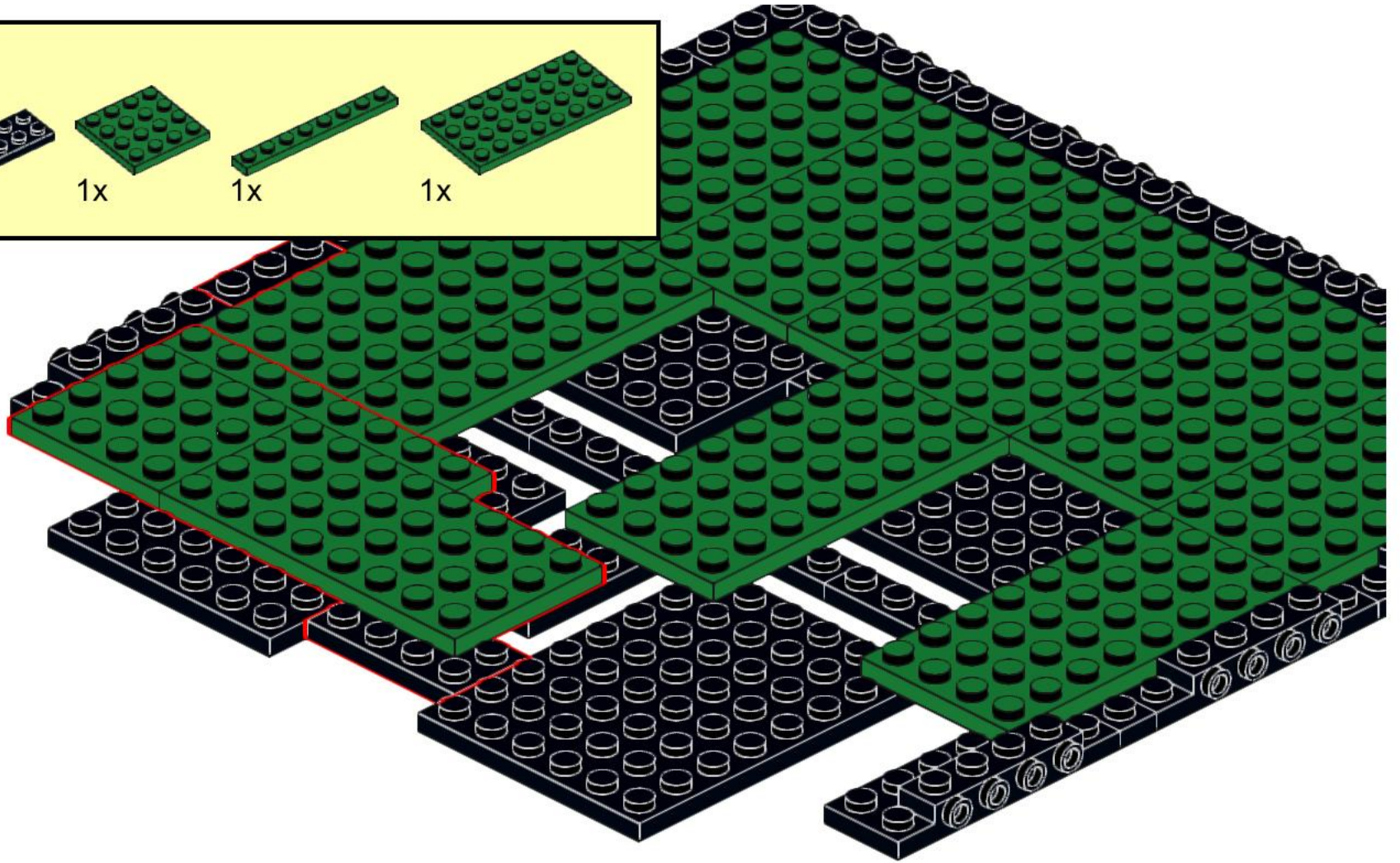
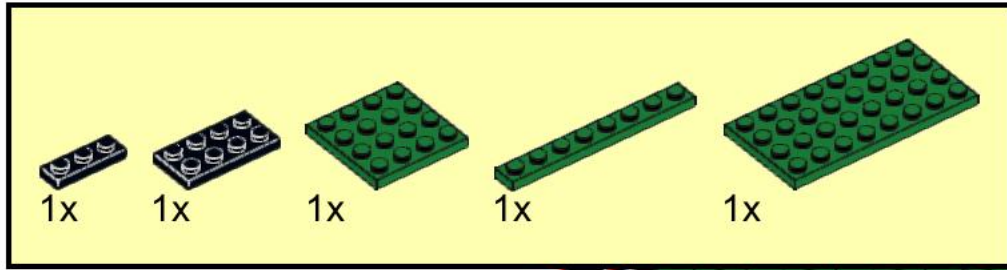

11

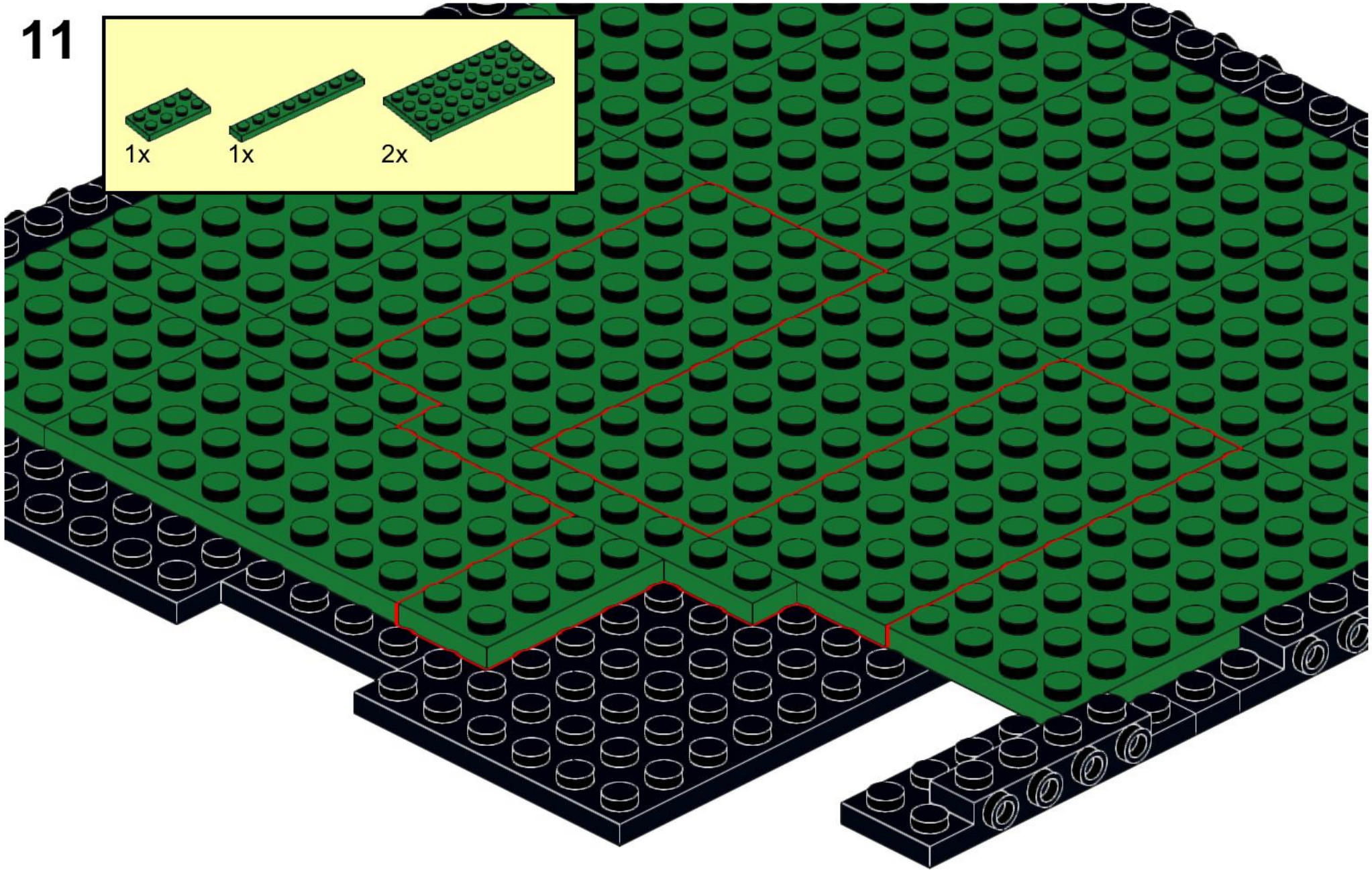
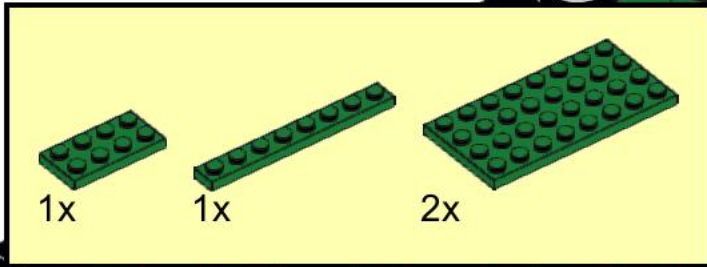

12

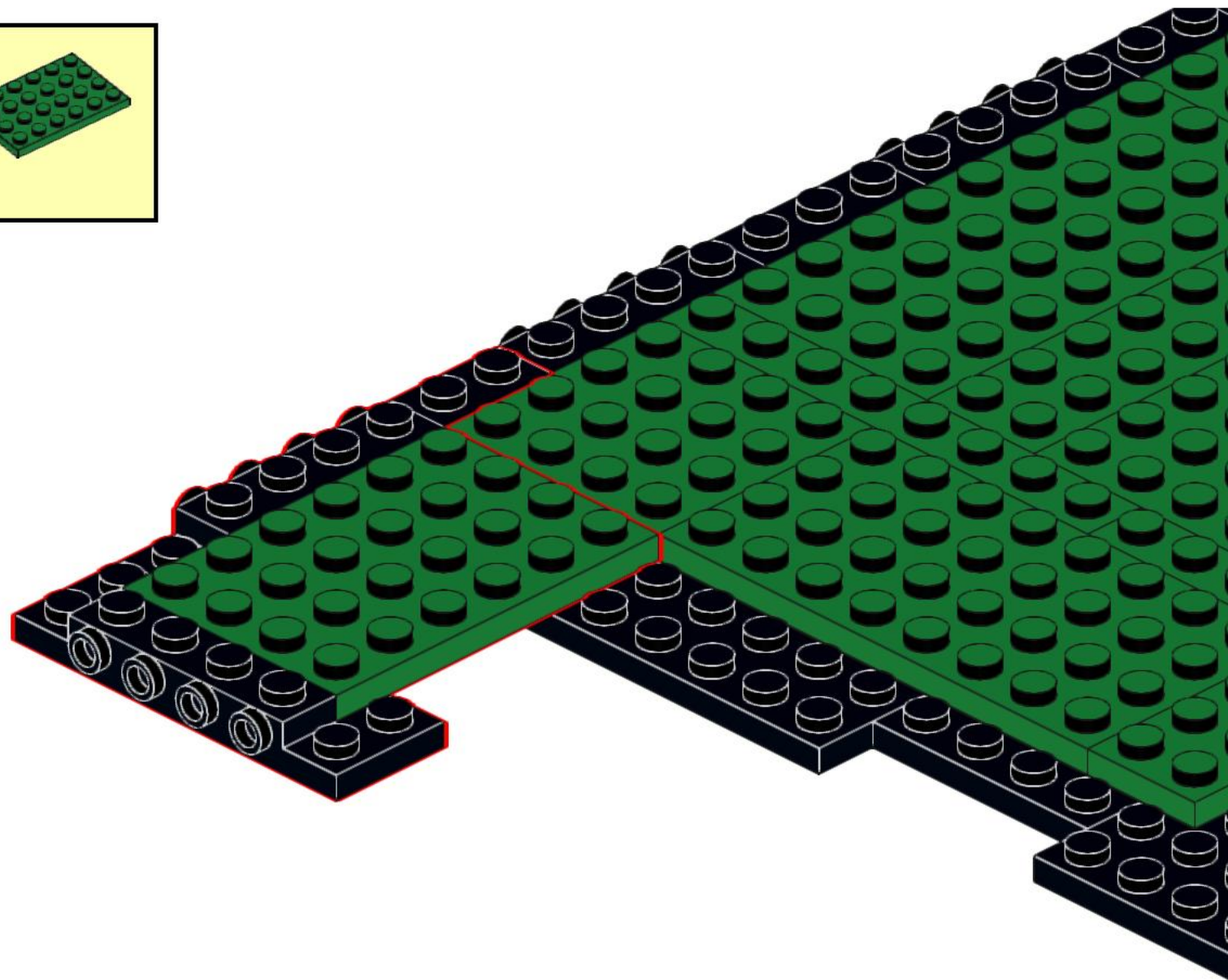
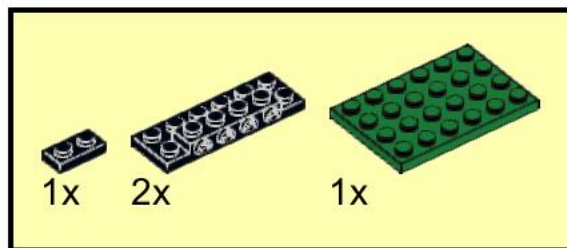

13

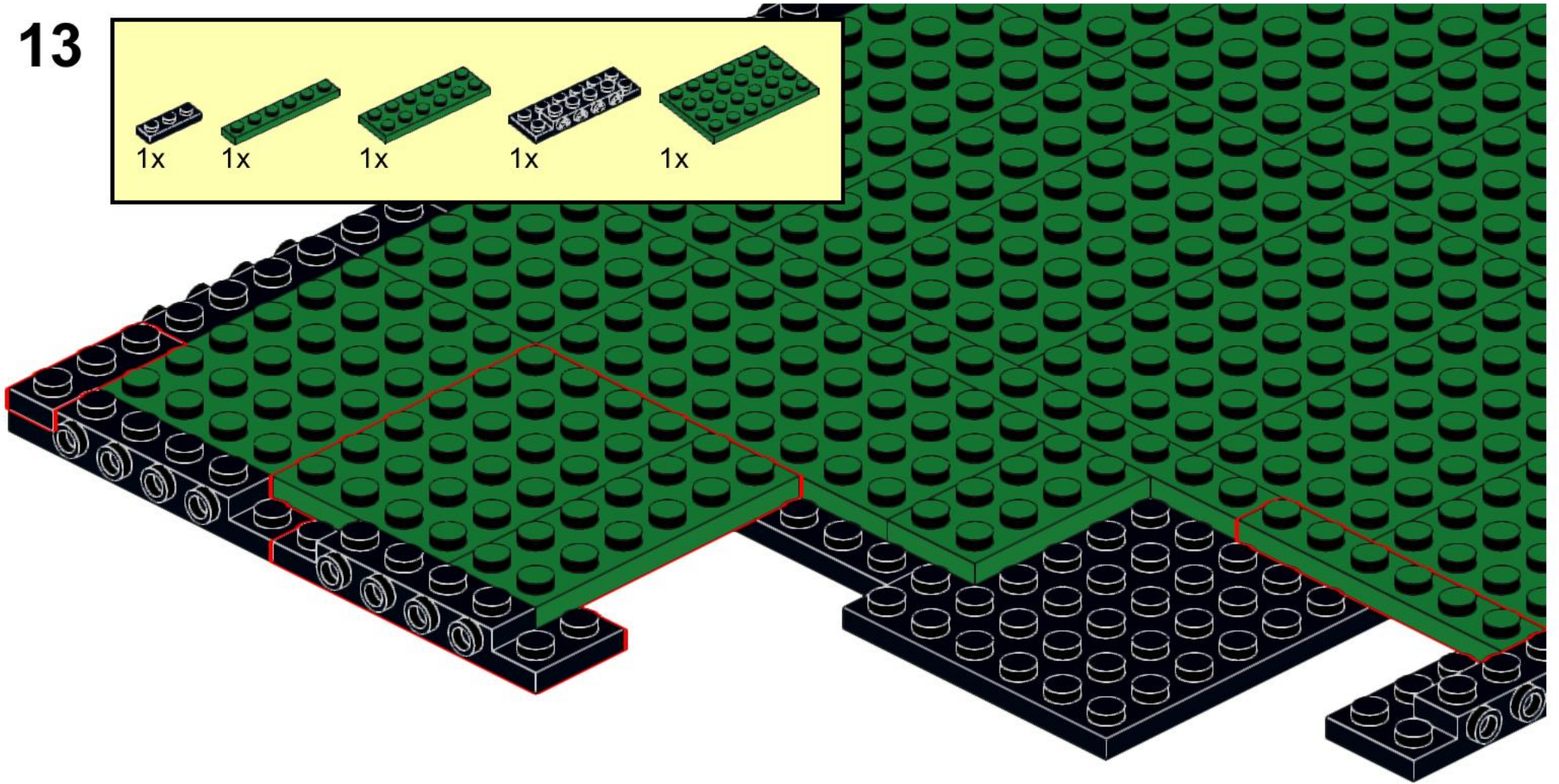
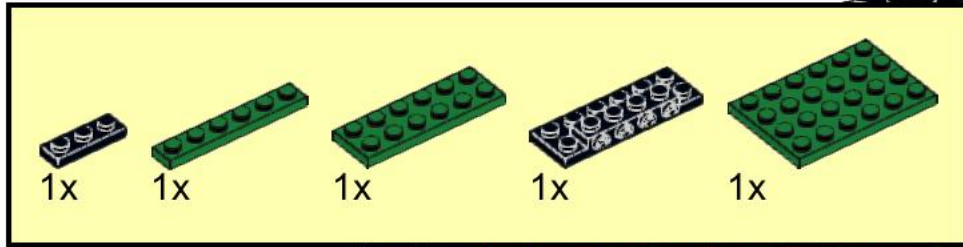

14

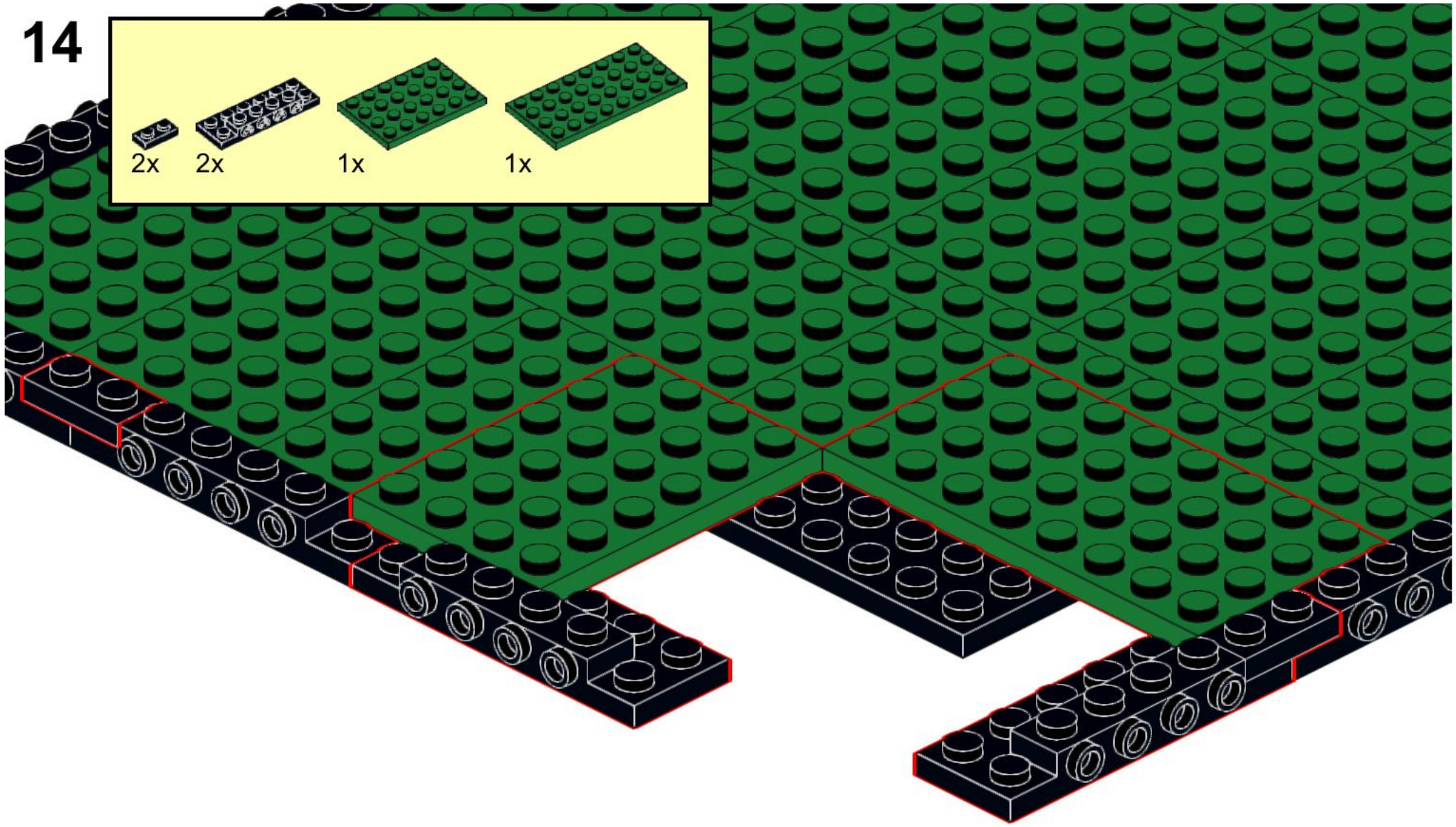
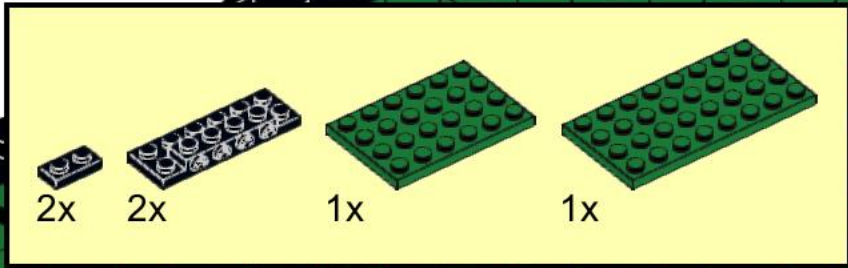

15

1x 2x 1x 1x

This inset box lists the required parts for step 15: one 1x2 black Technic brick with a hole, two 1x2 black Technic bricks with holes, one 1x4 black Technic brick with four holes, and one 1x4 green Technic plate with four holes.

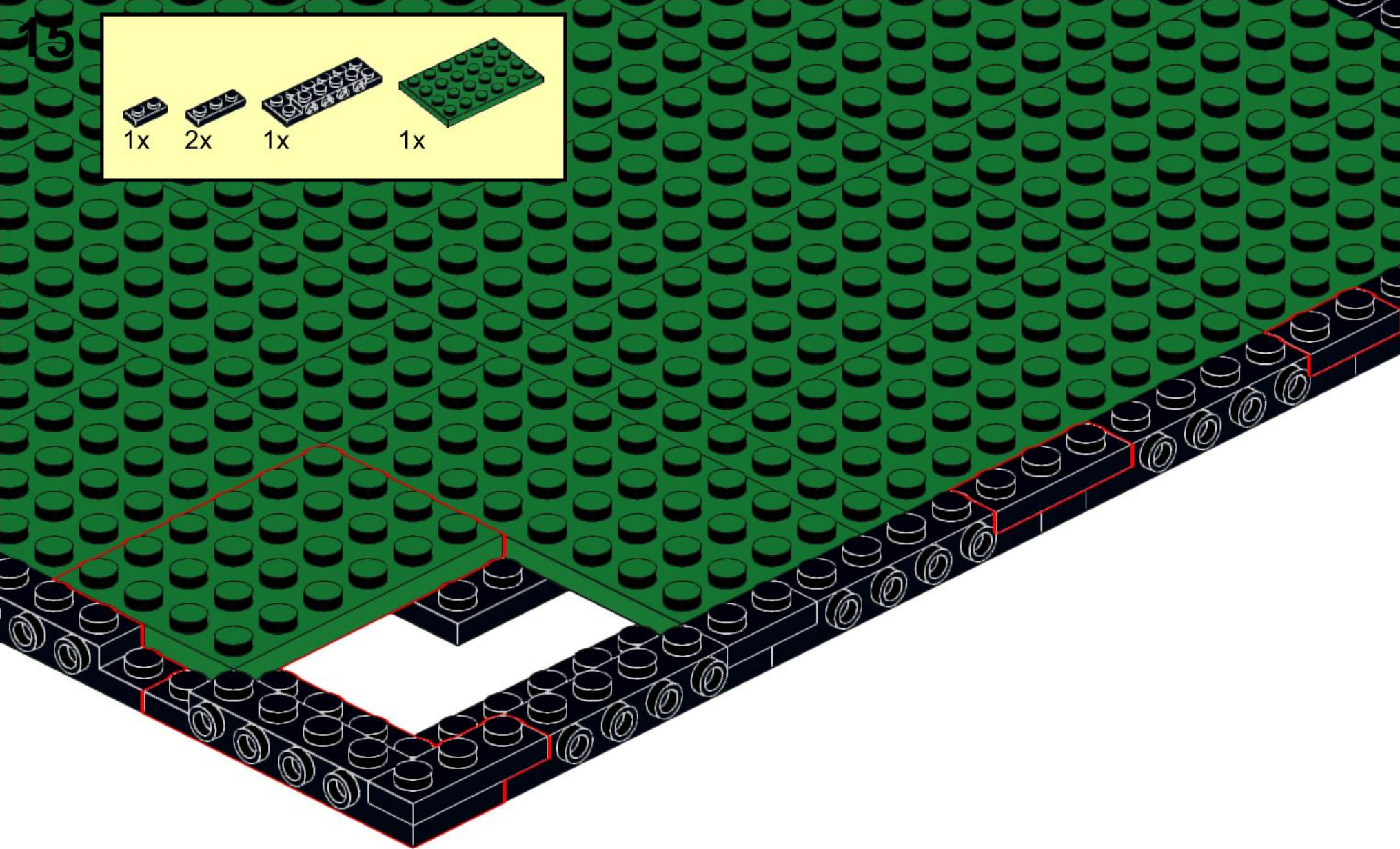

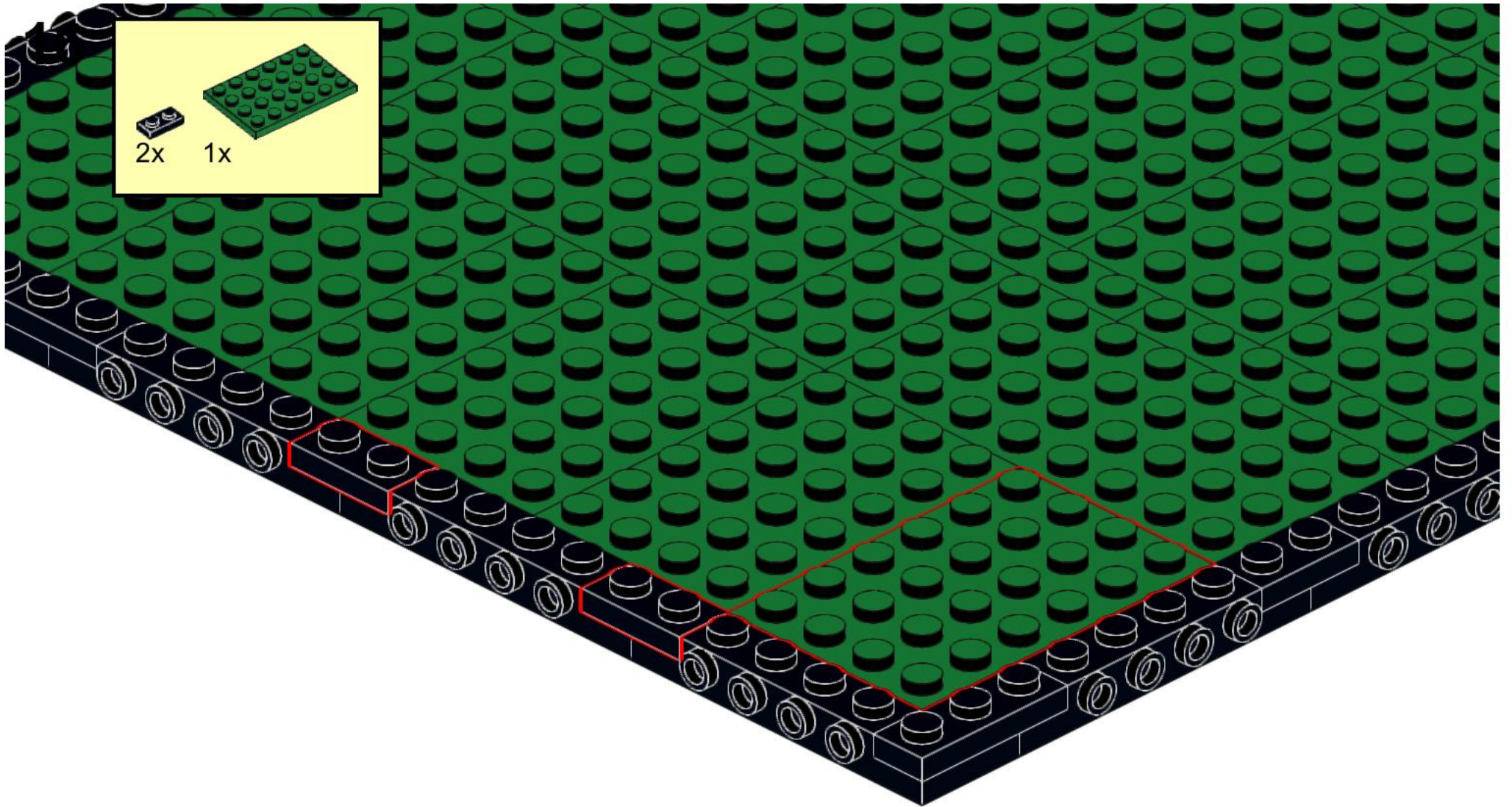

2x 1x

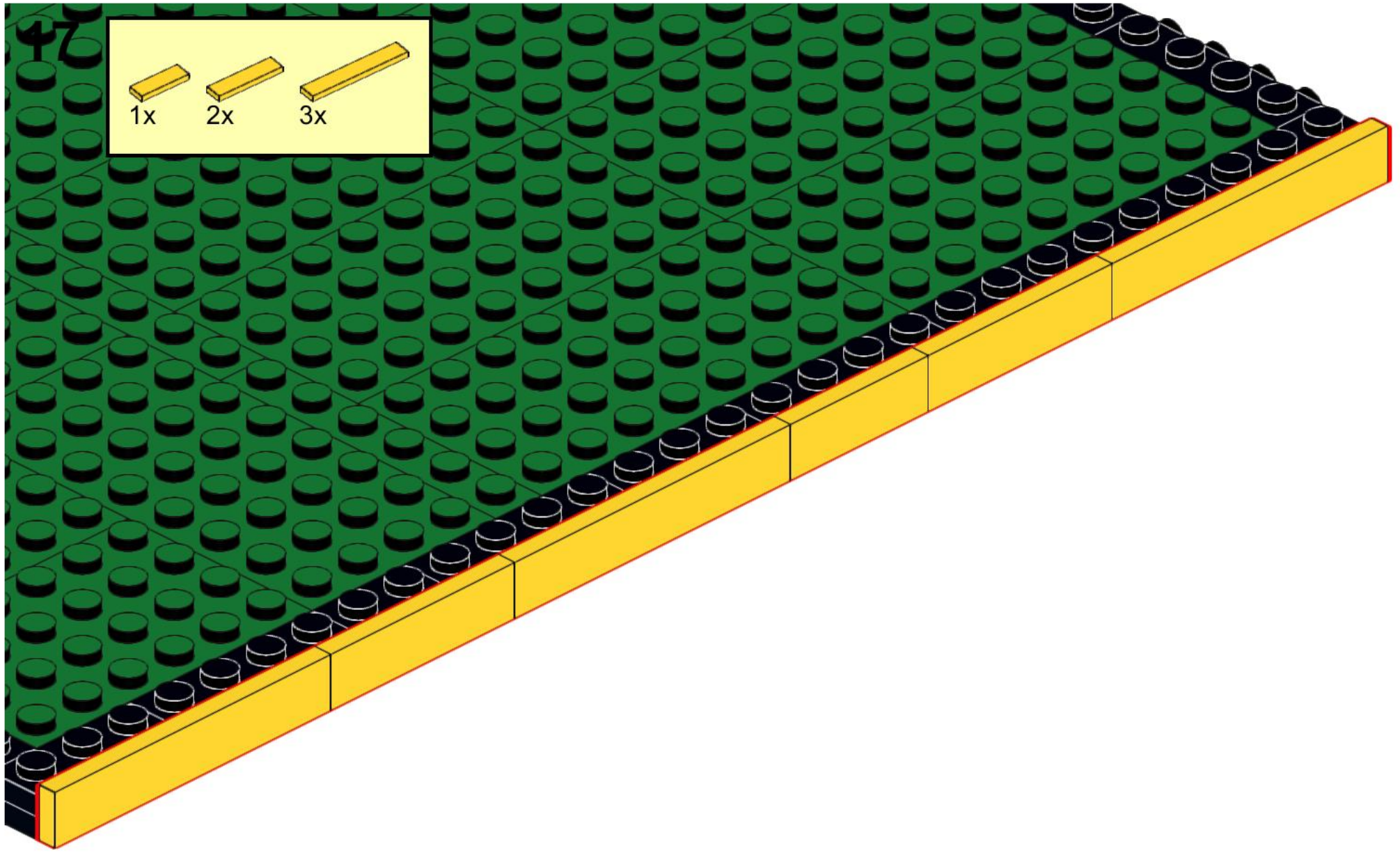

1x 2x 3x

18

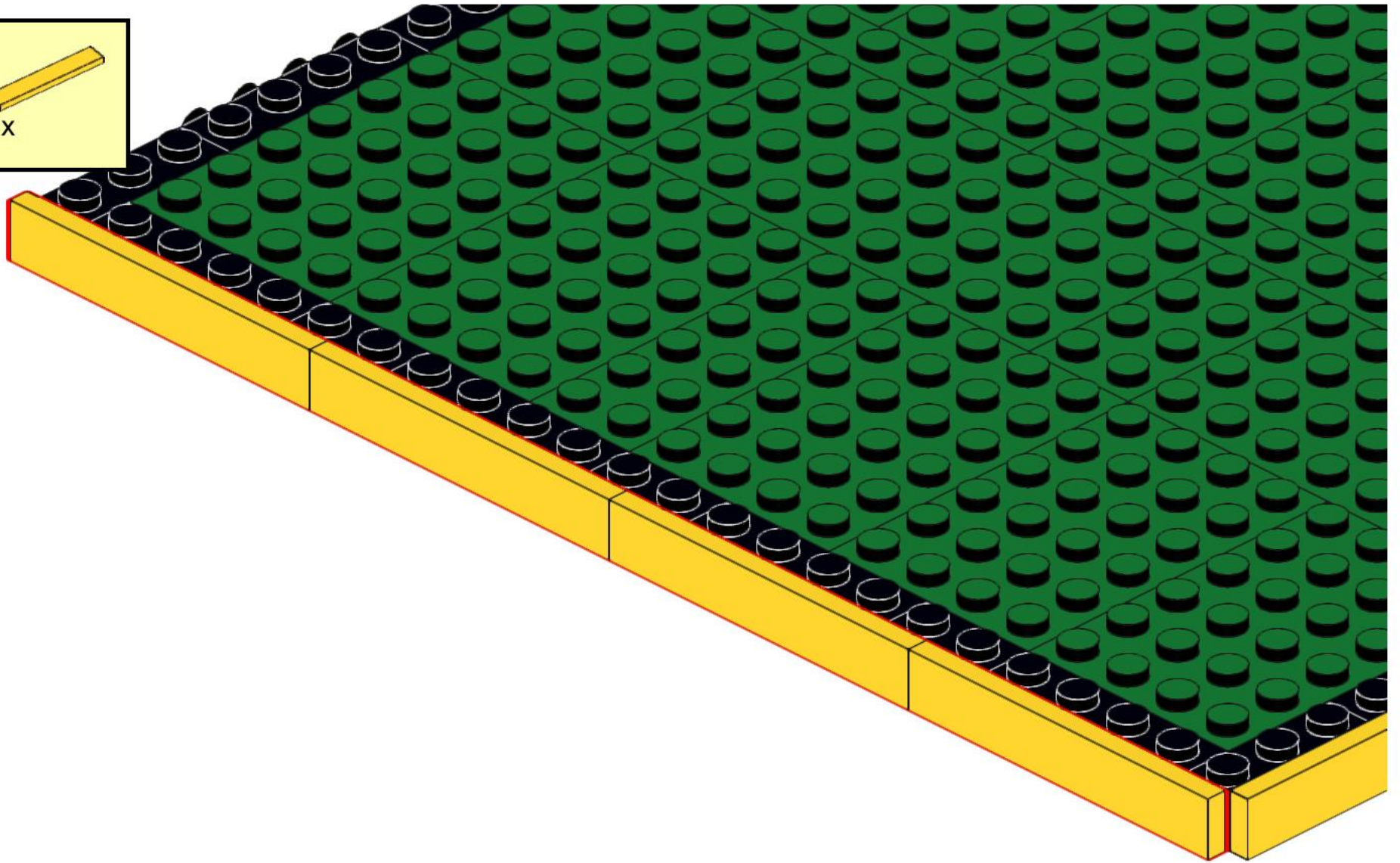
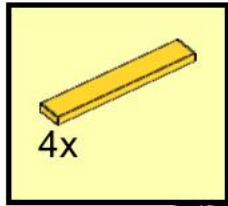

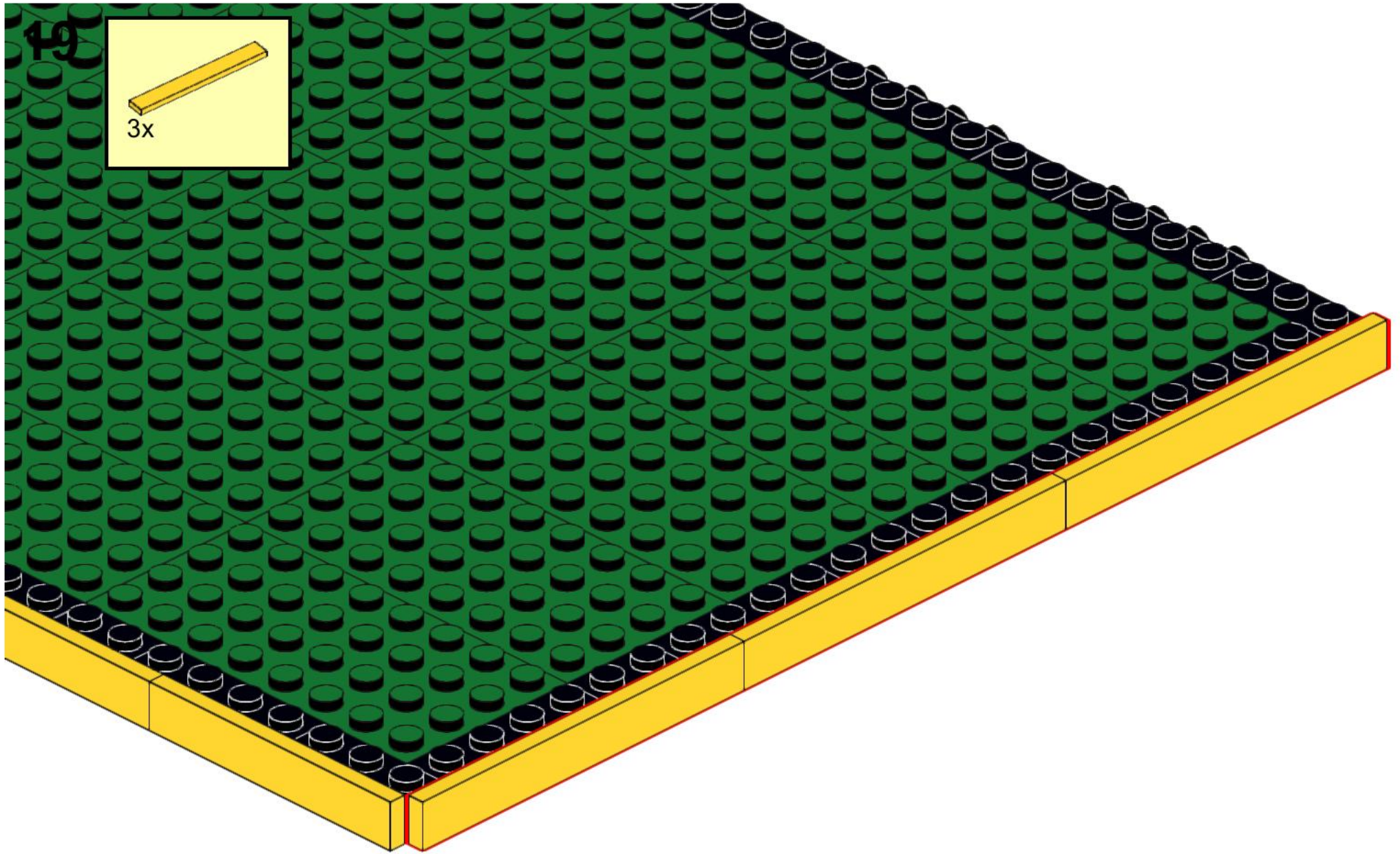

5

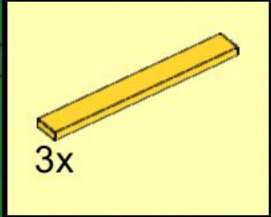

3x

20

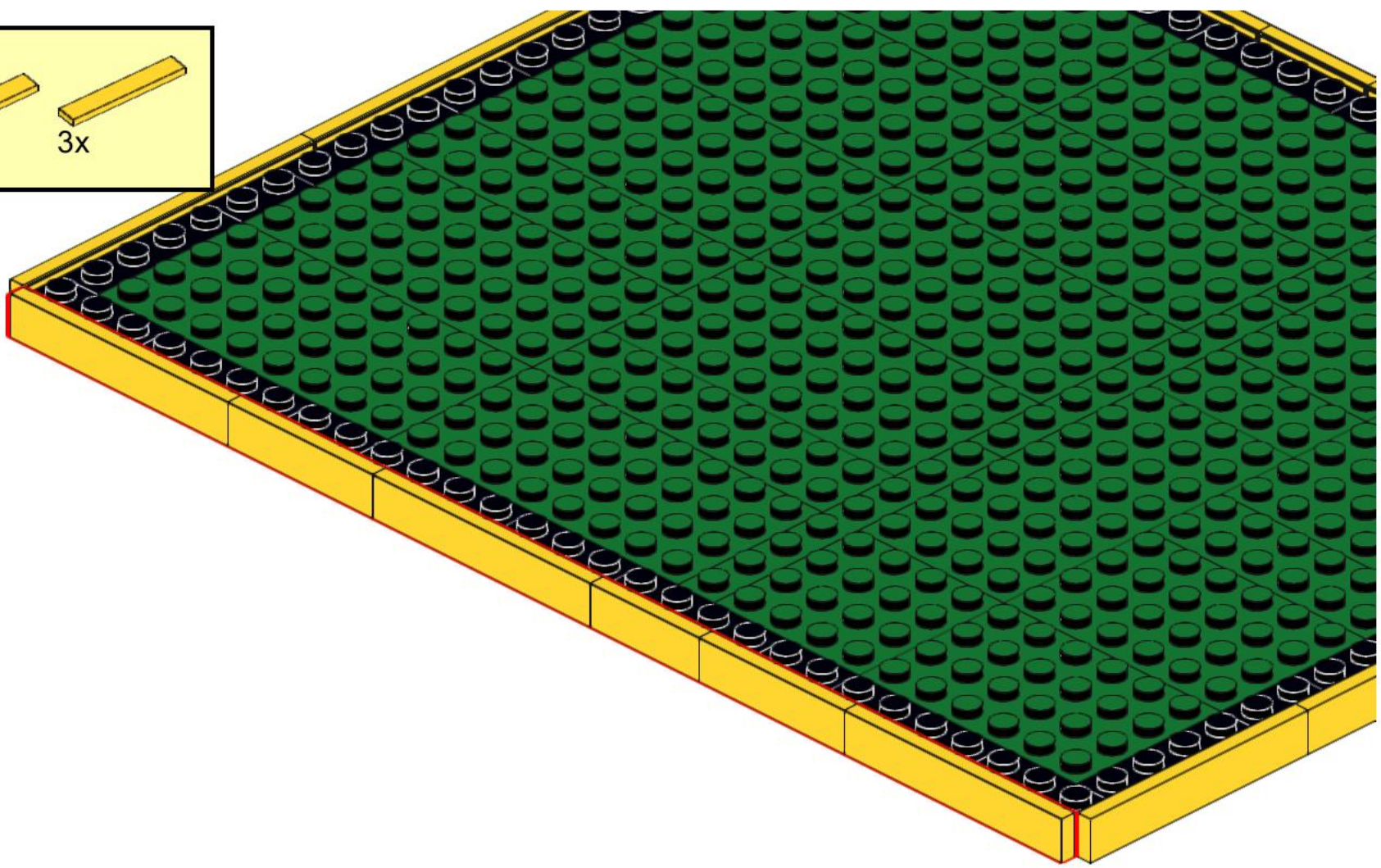
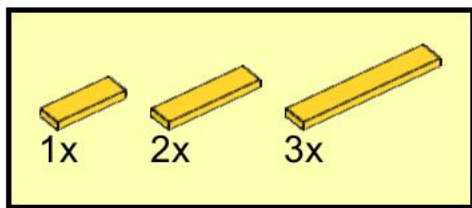

2

21

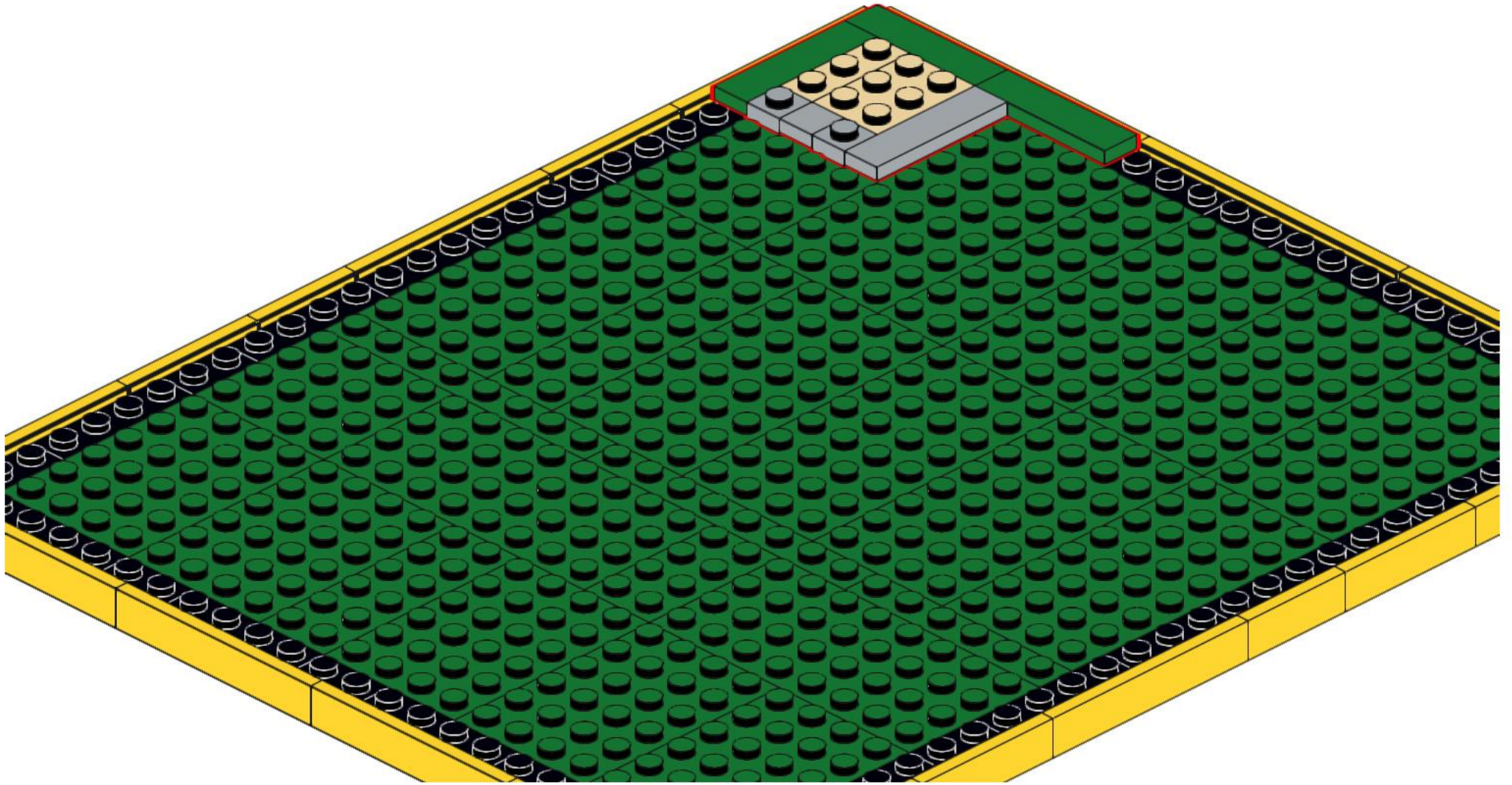
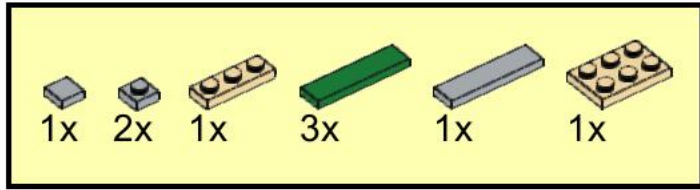

22

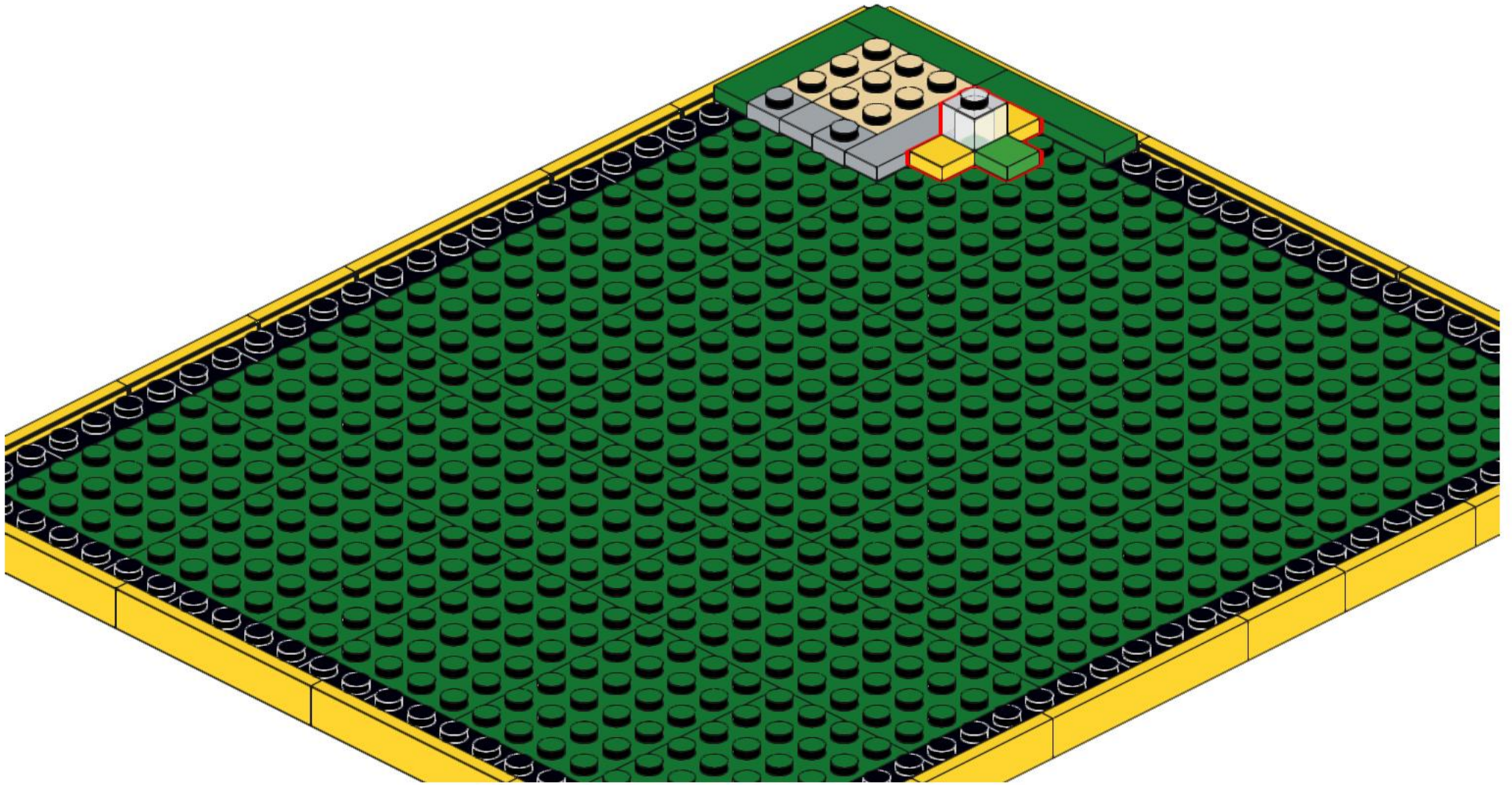
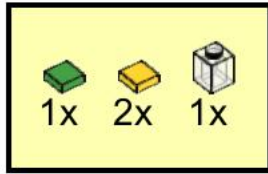

23

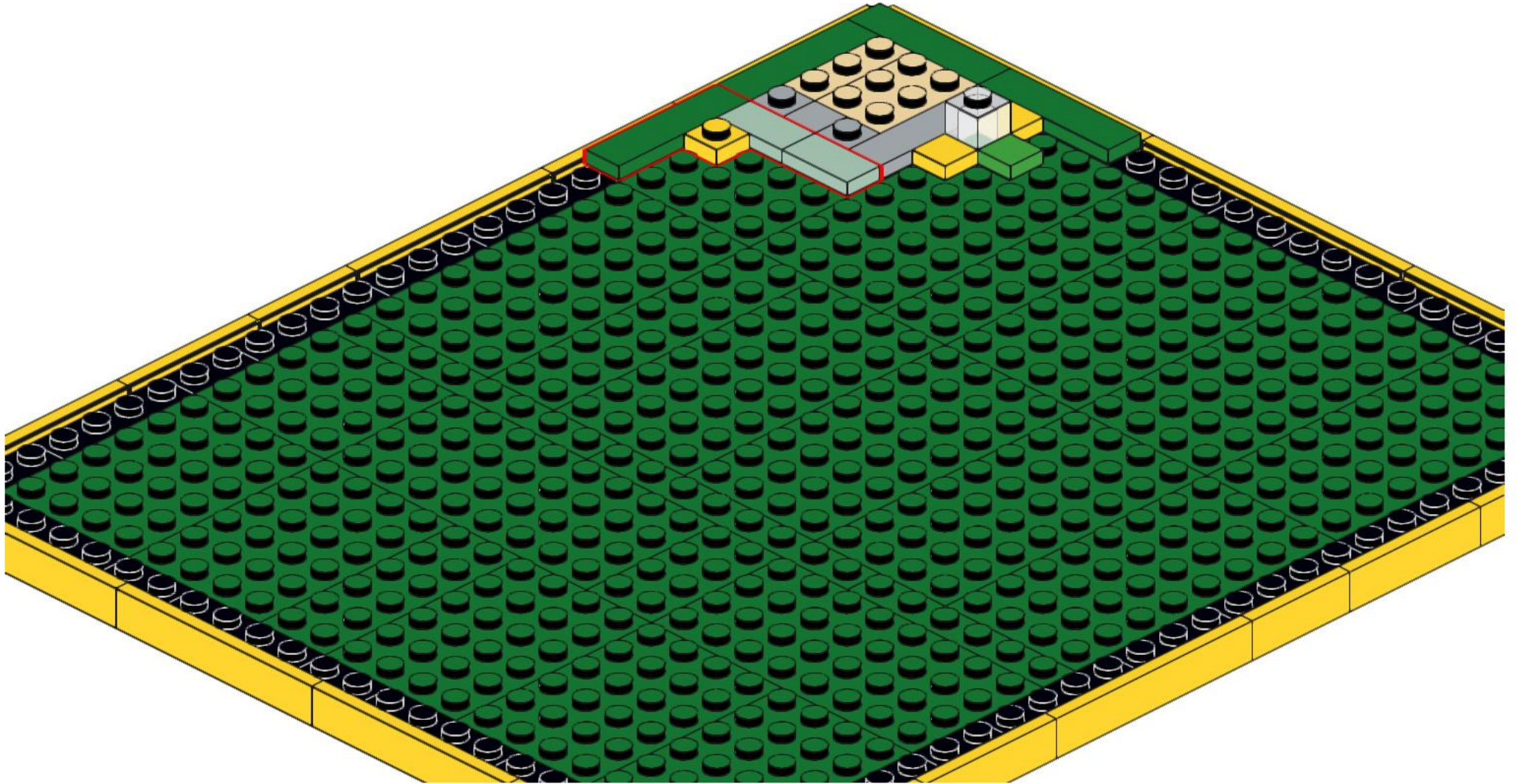
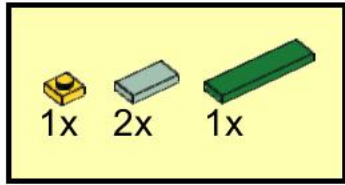

24

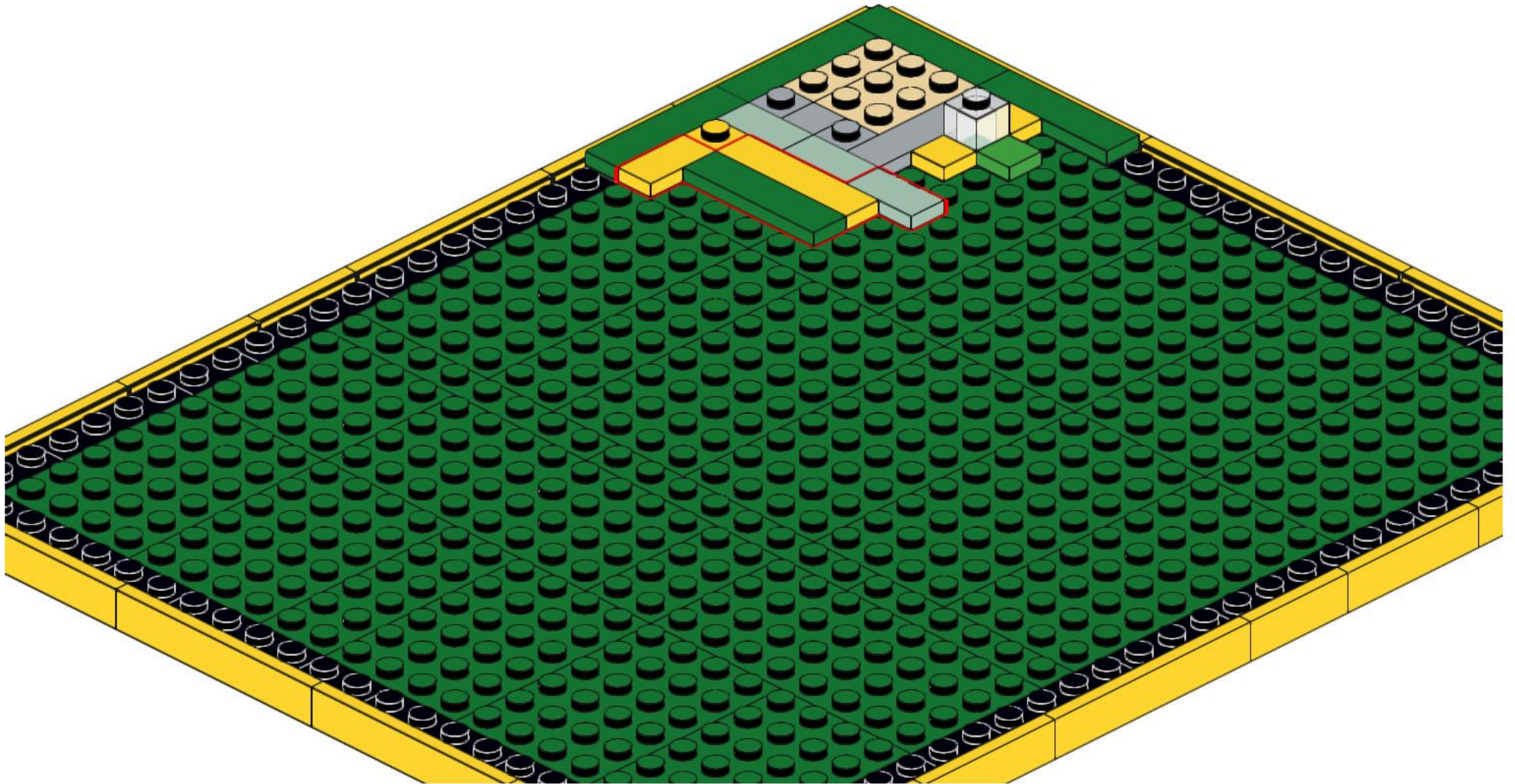
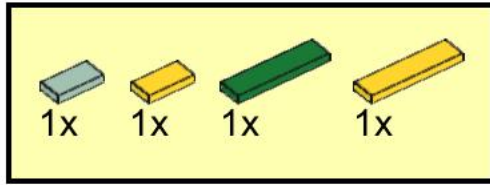

25

		
1x	2x	2x

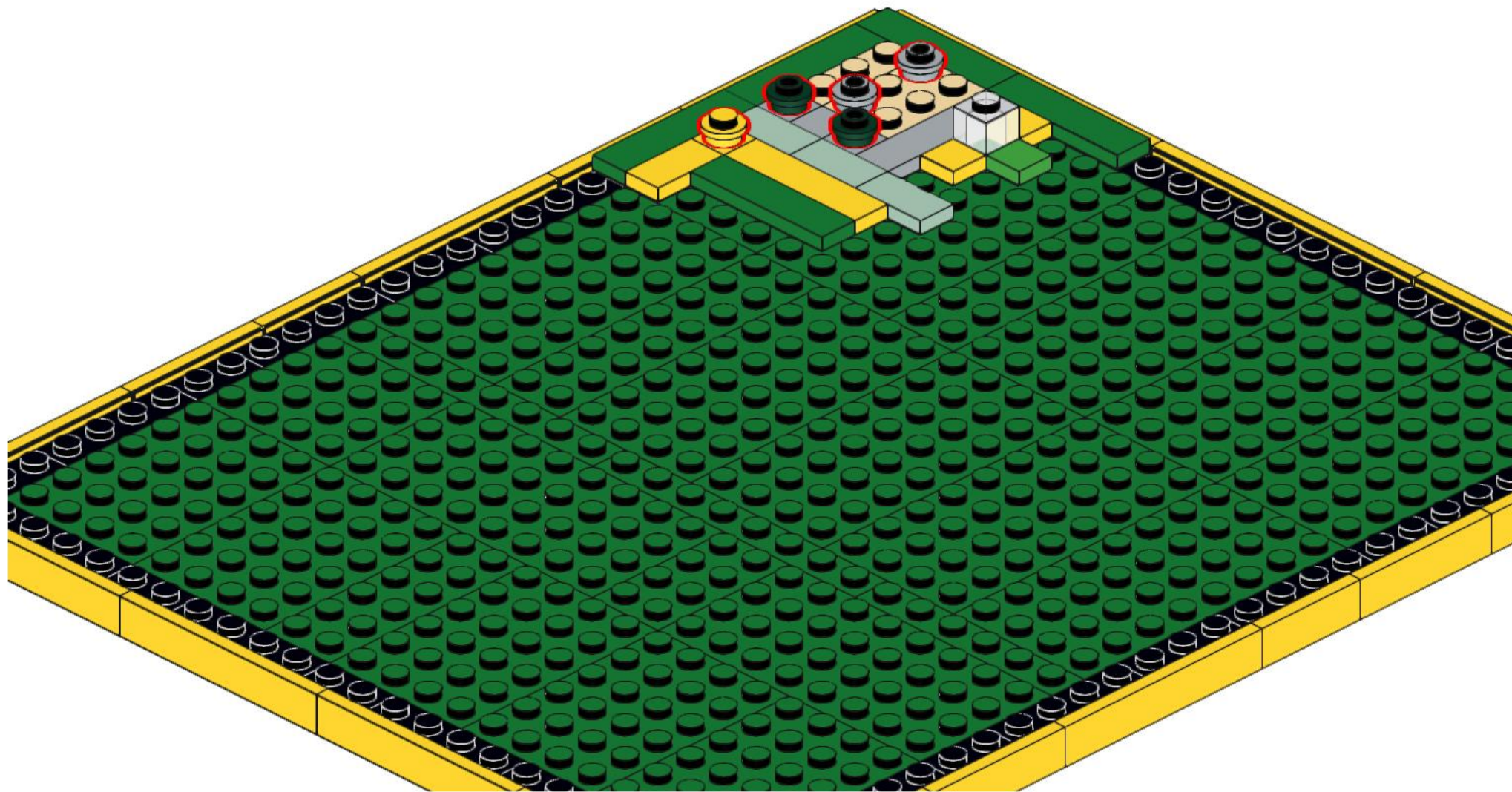

26

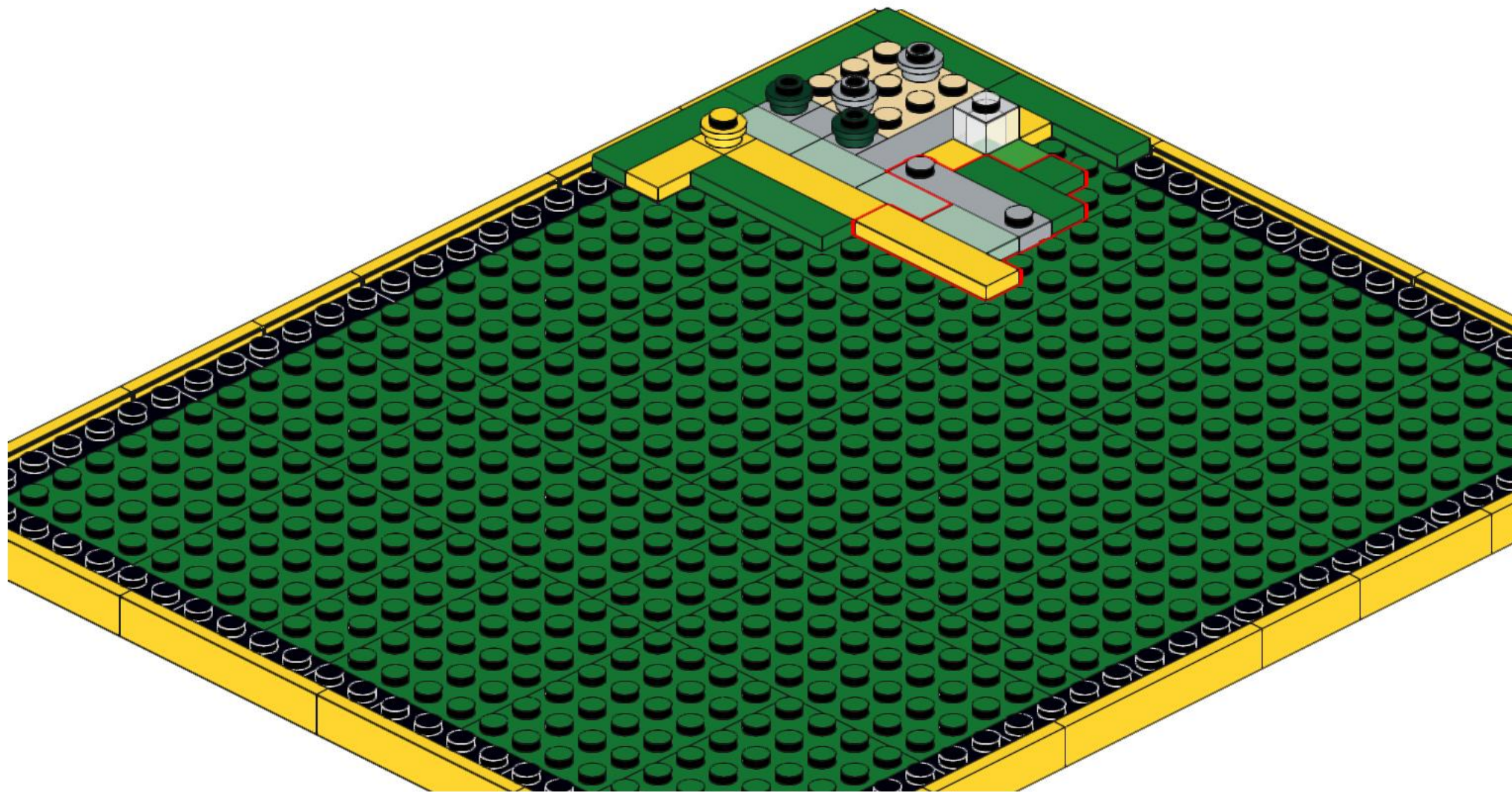
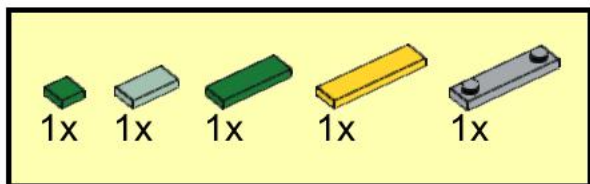

27

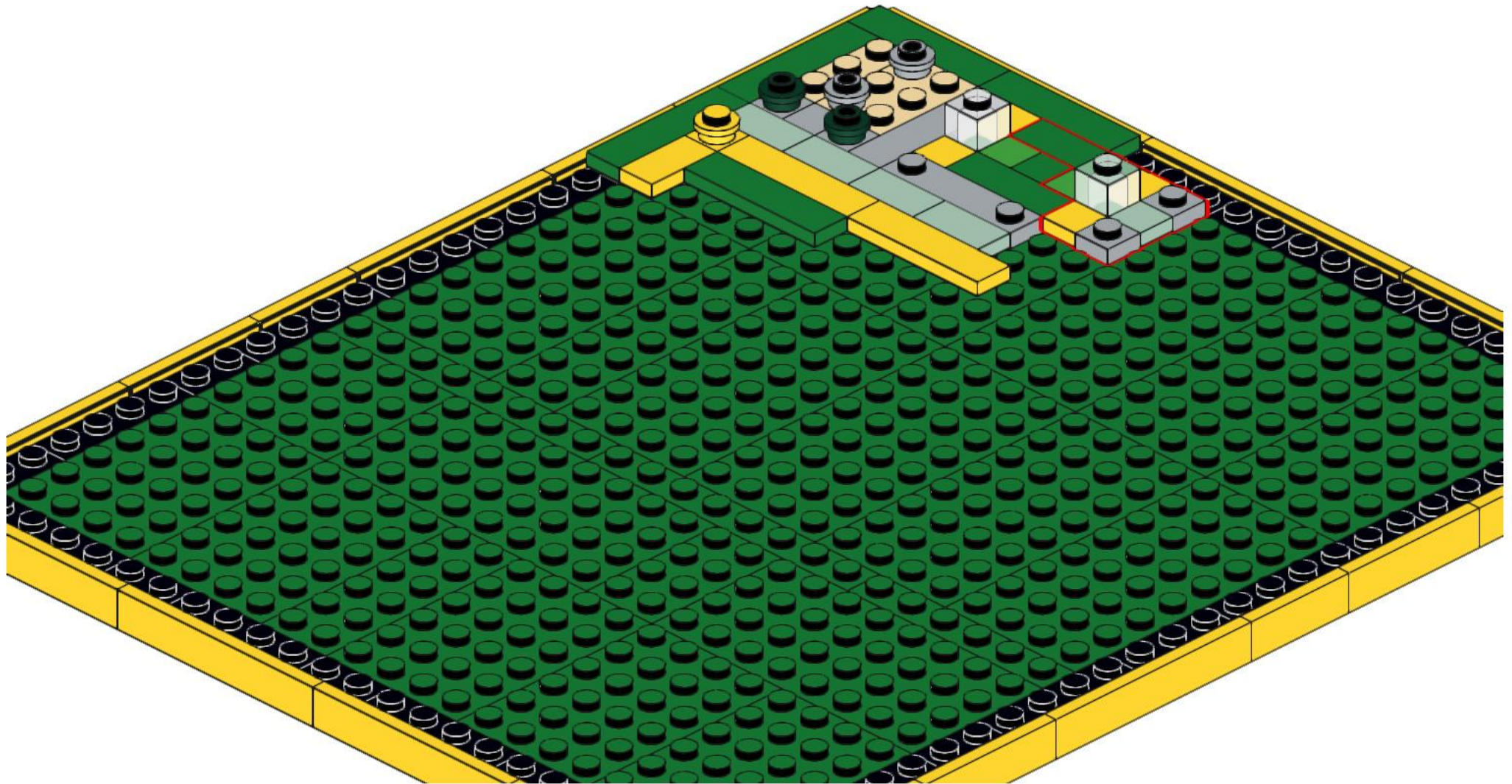
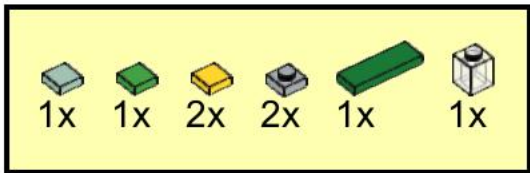

28

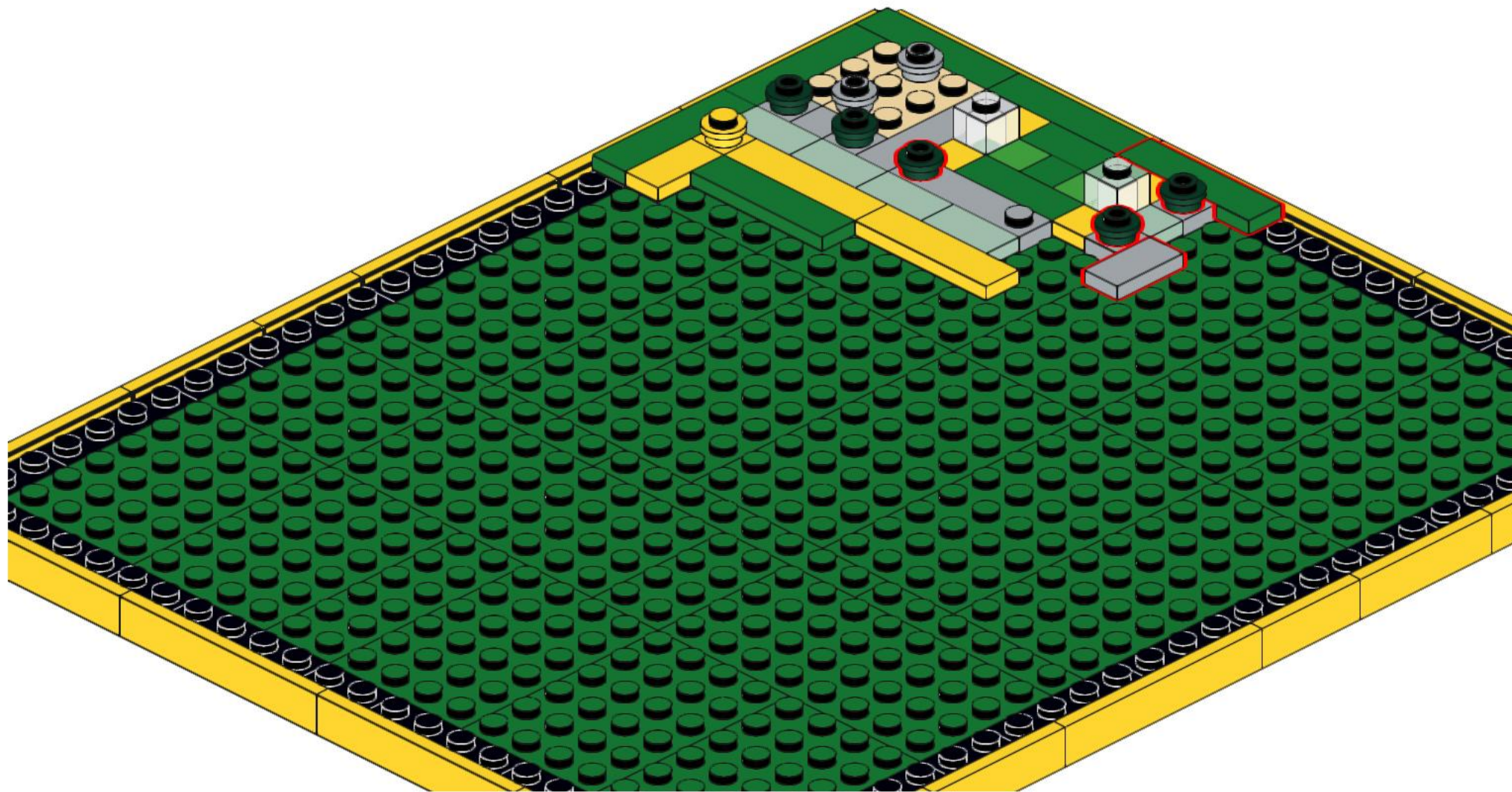
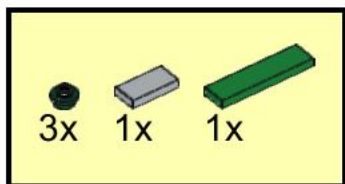

29

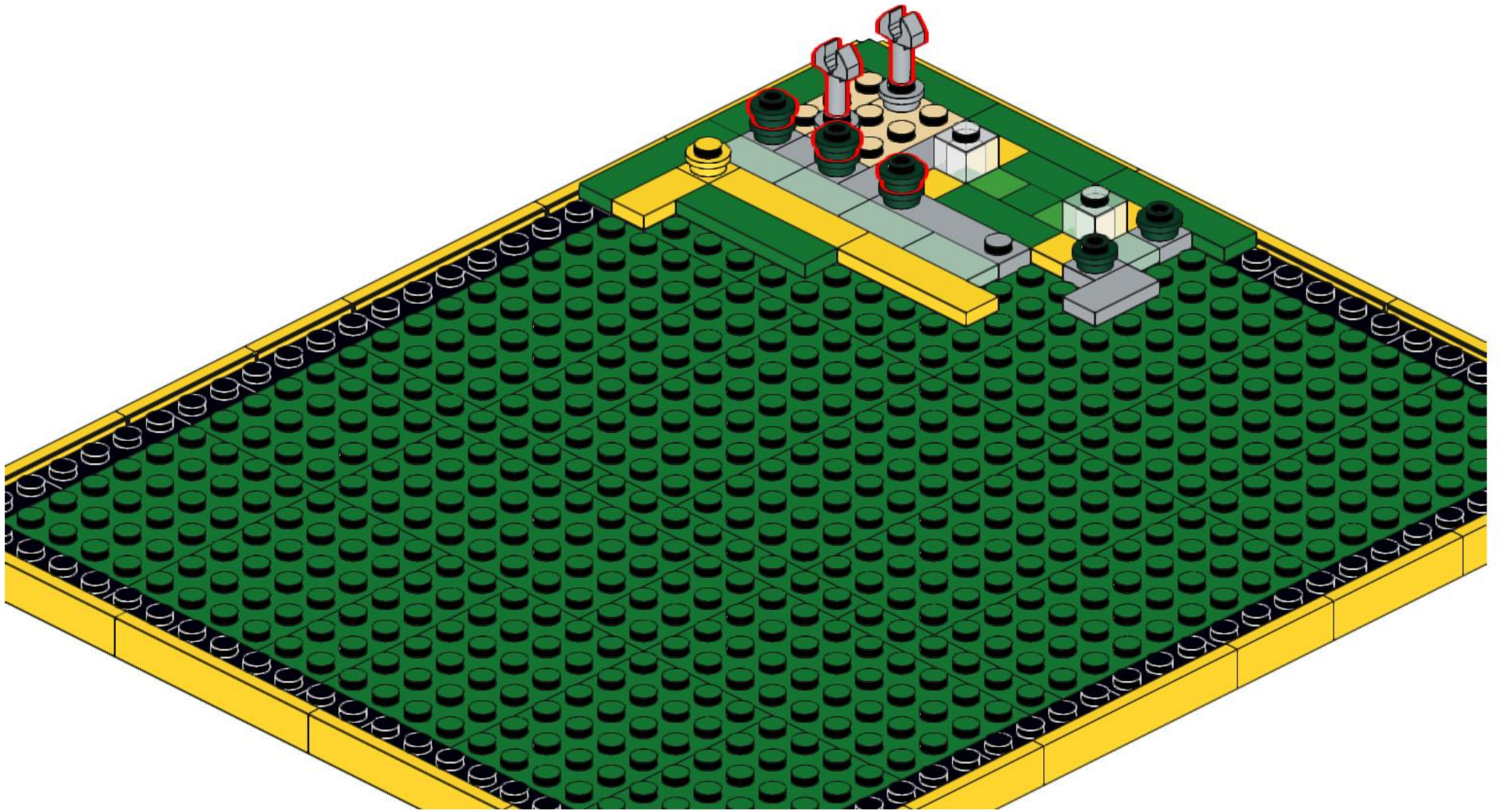
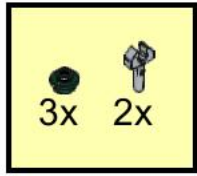

30

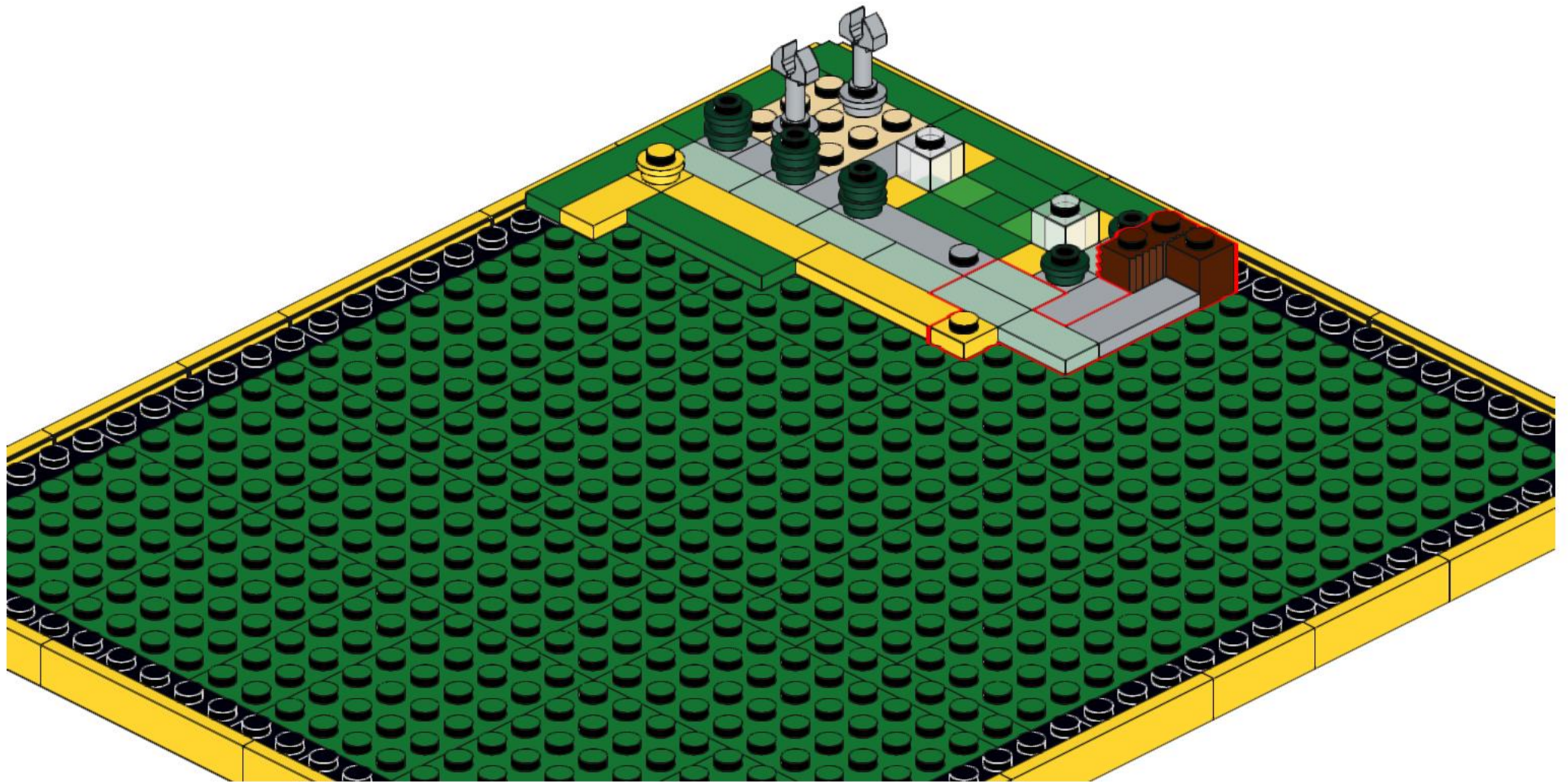
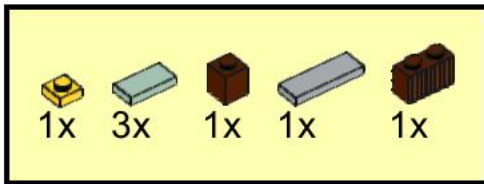

31

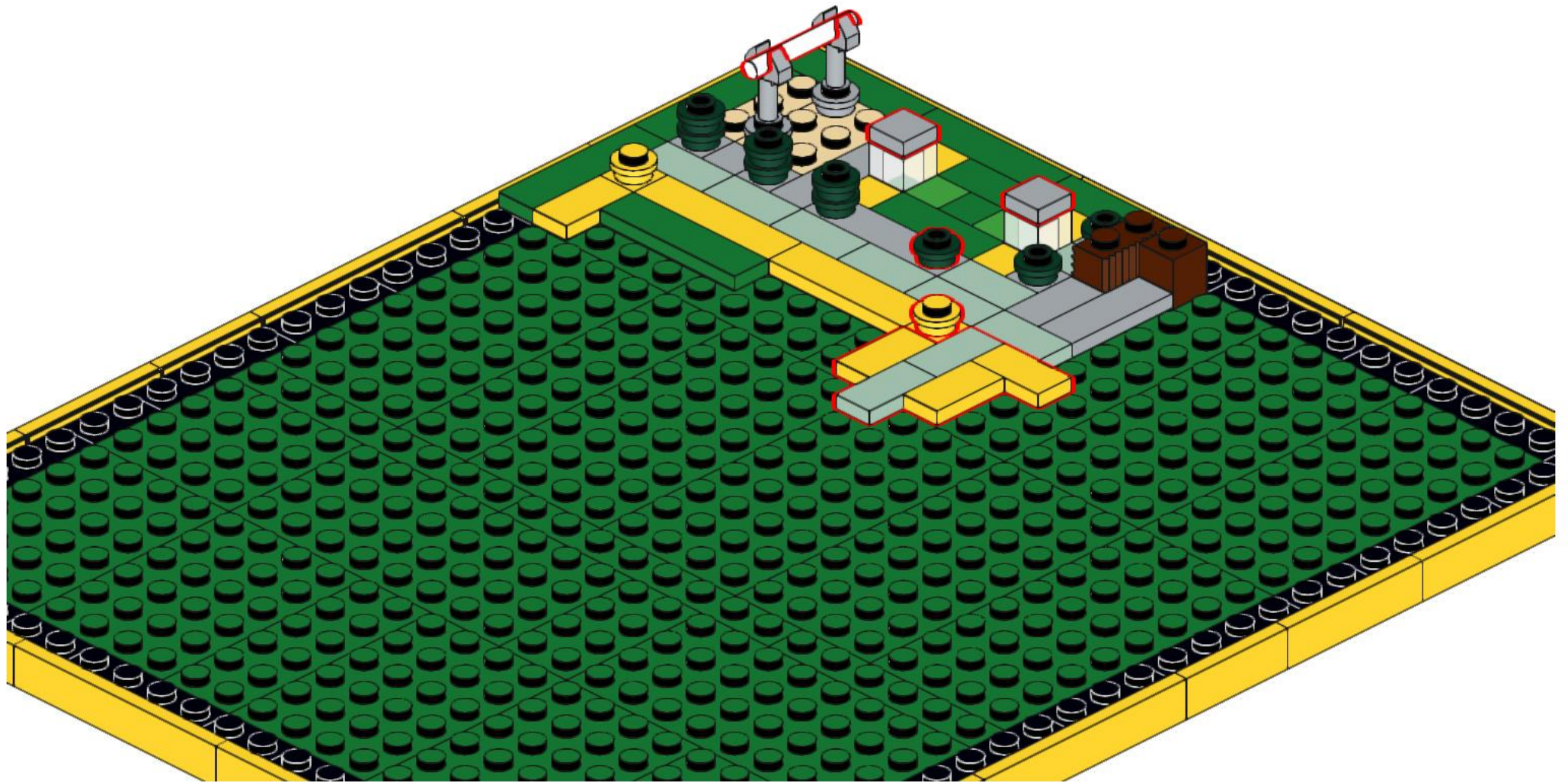
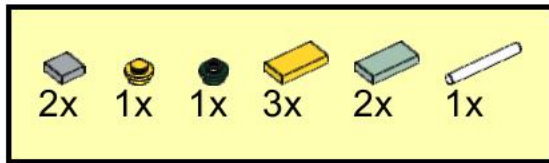

32

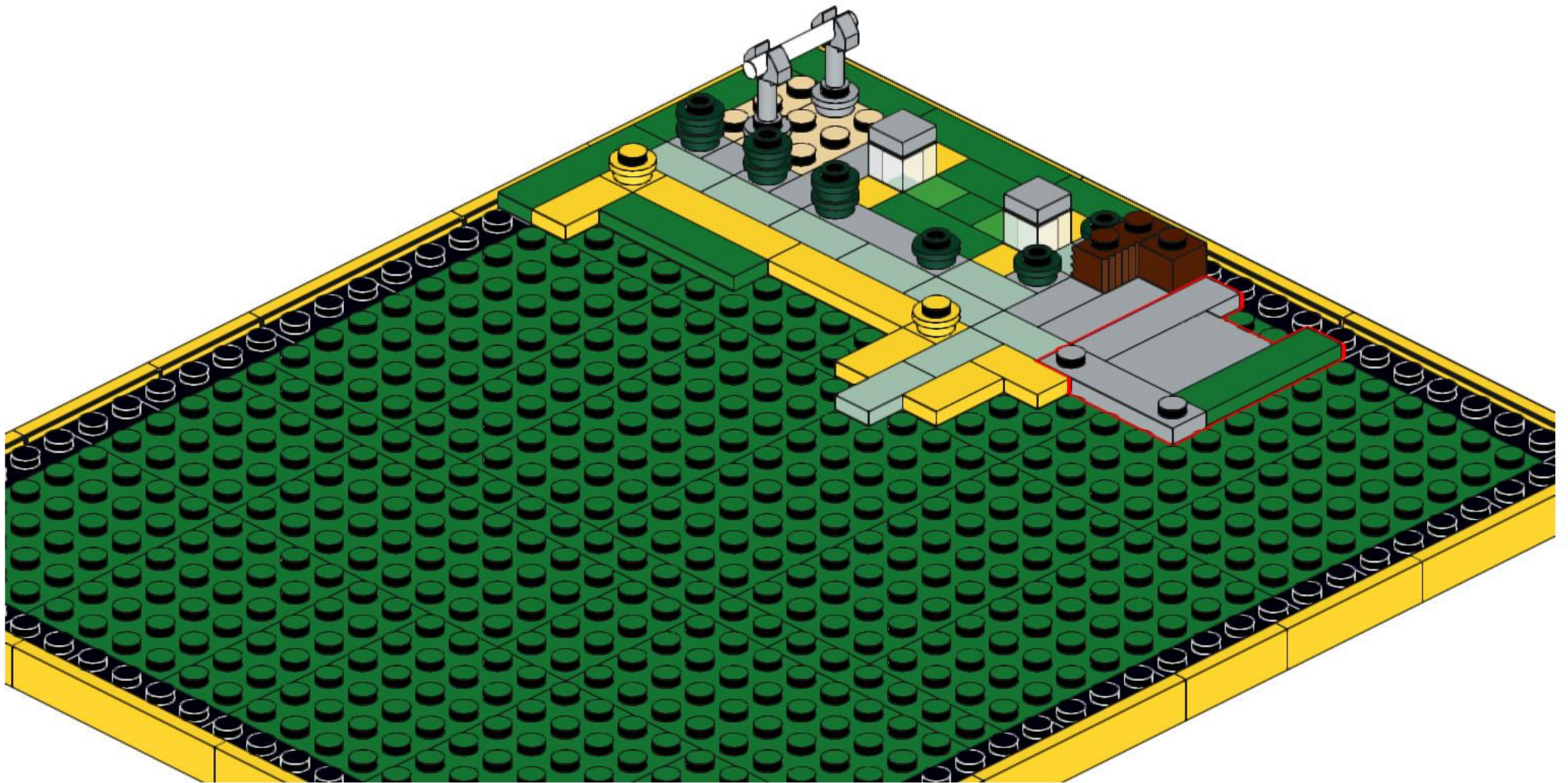
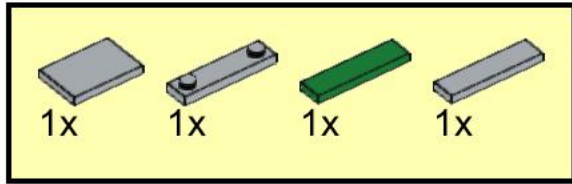

33

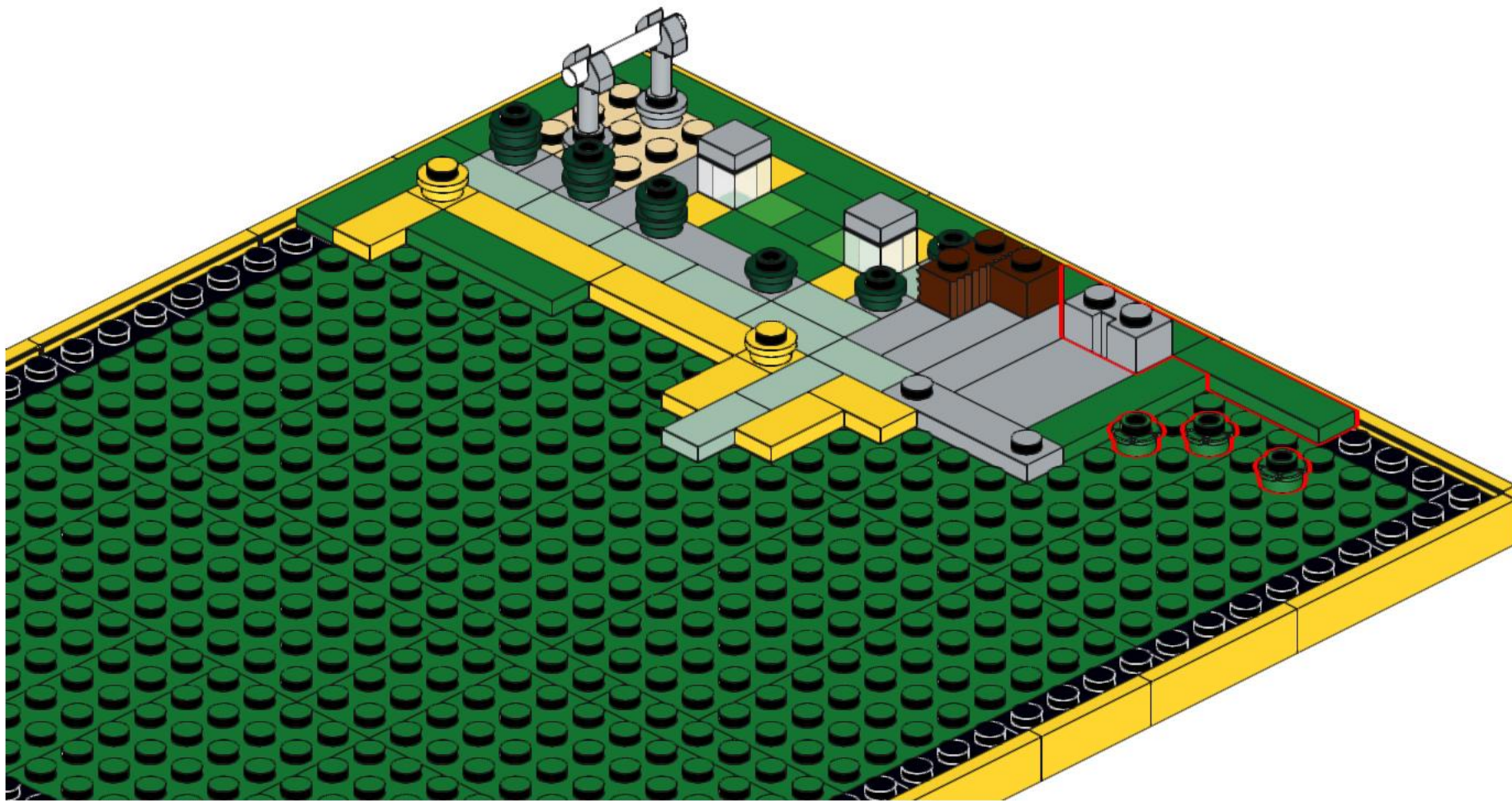
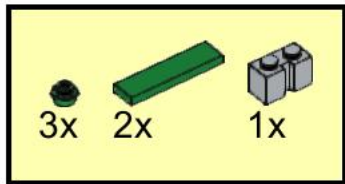

34

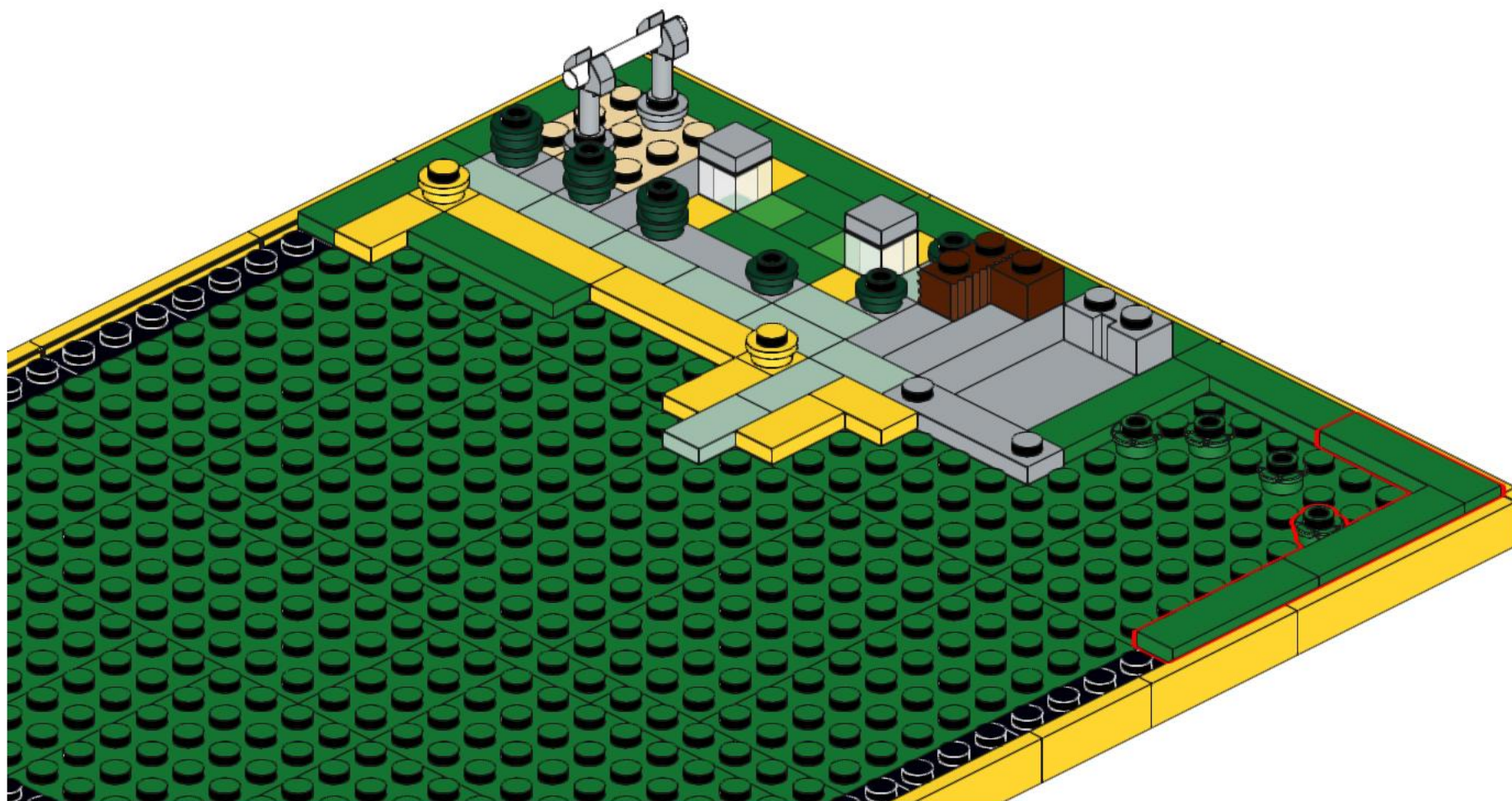
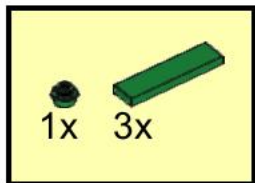

35

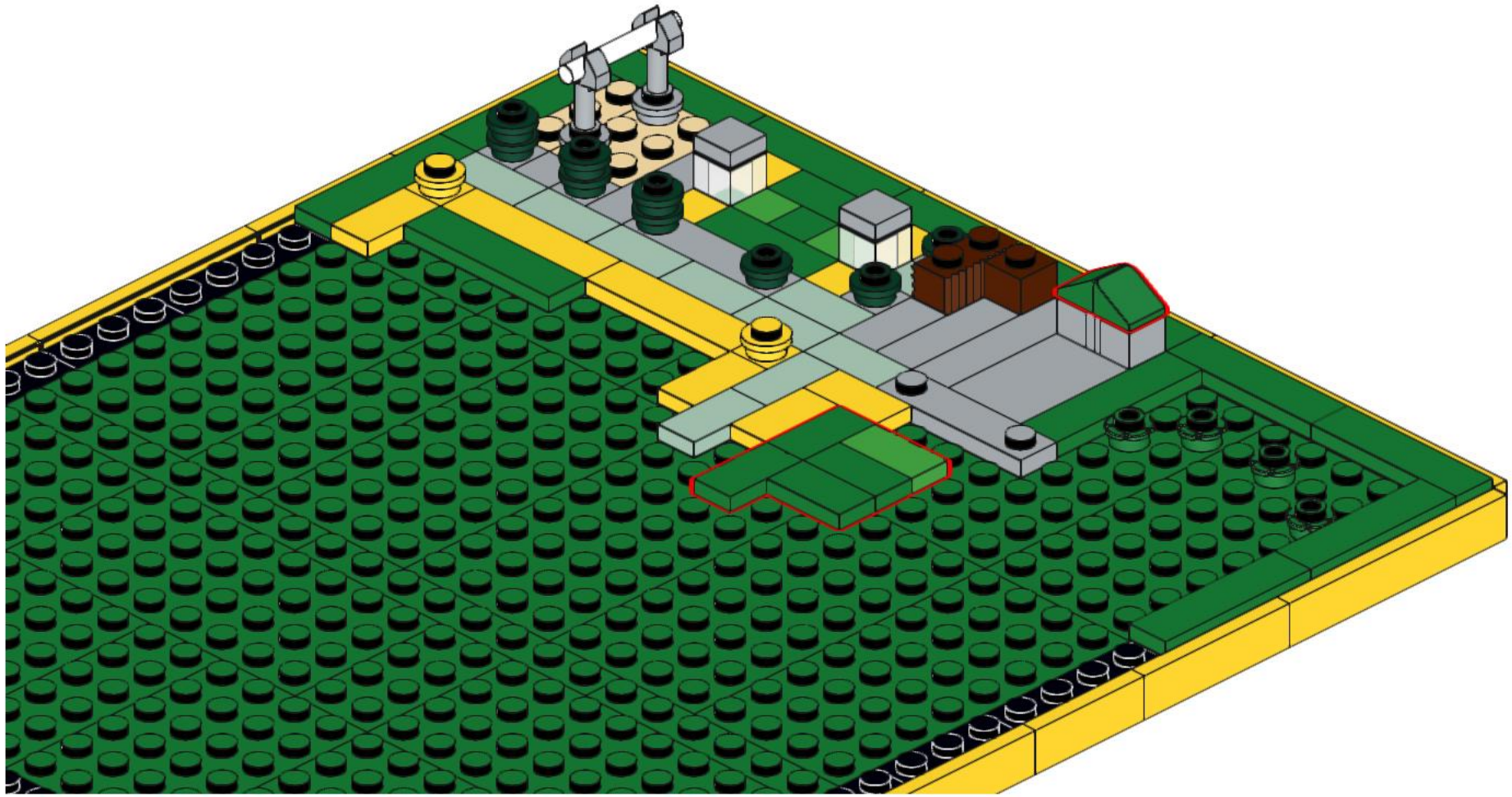
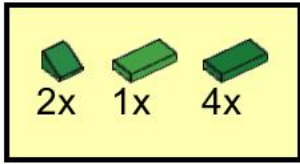

36

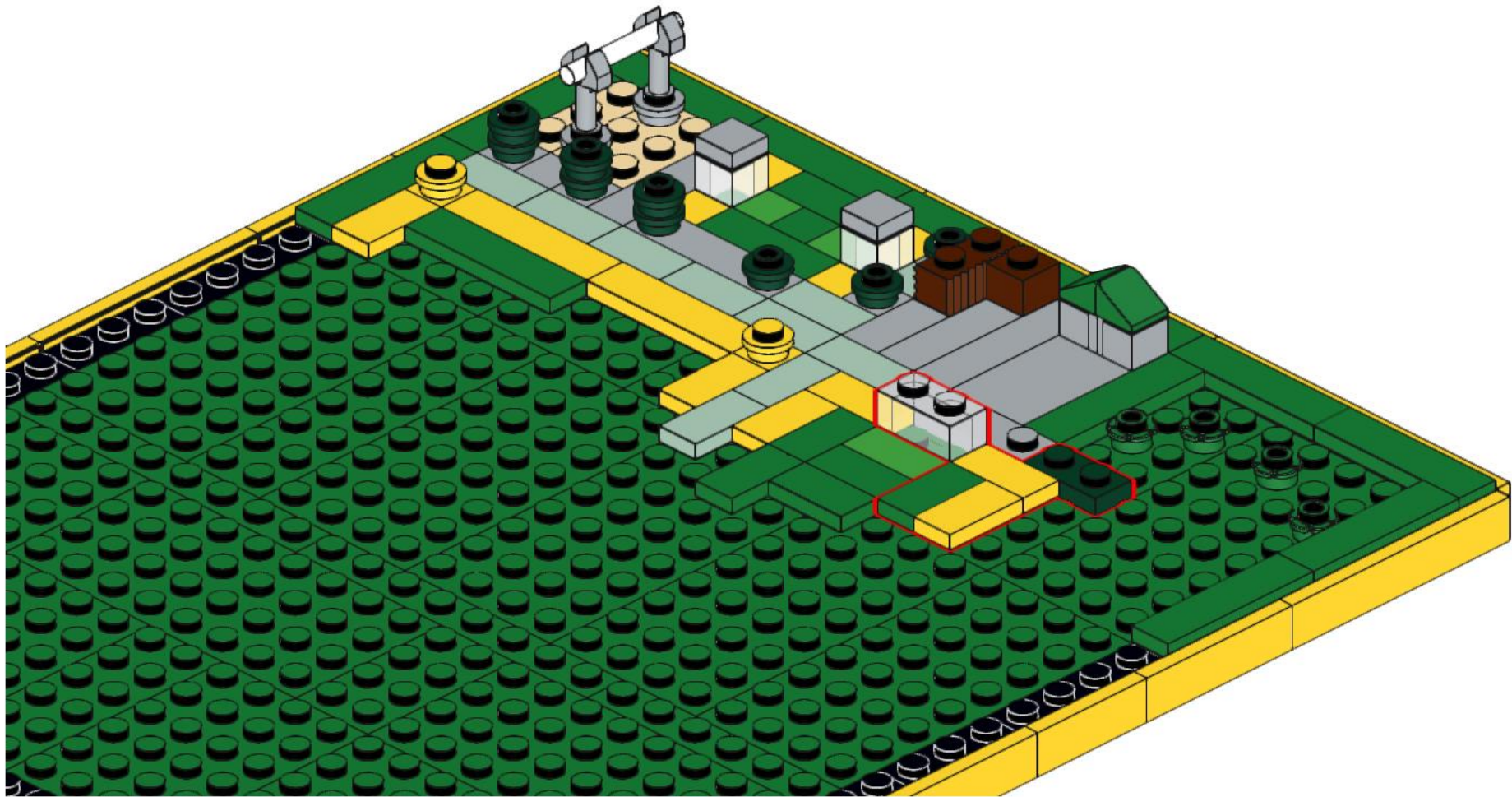
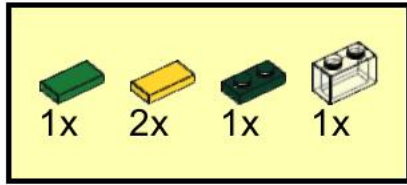

37

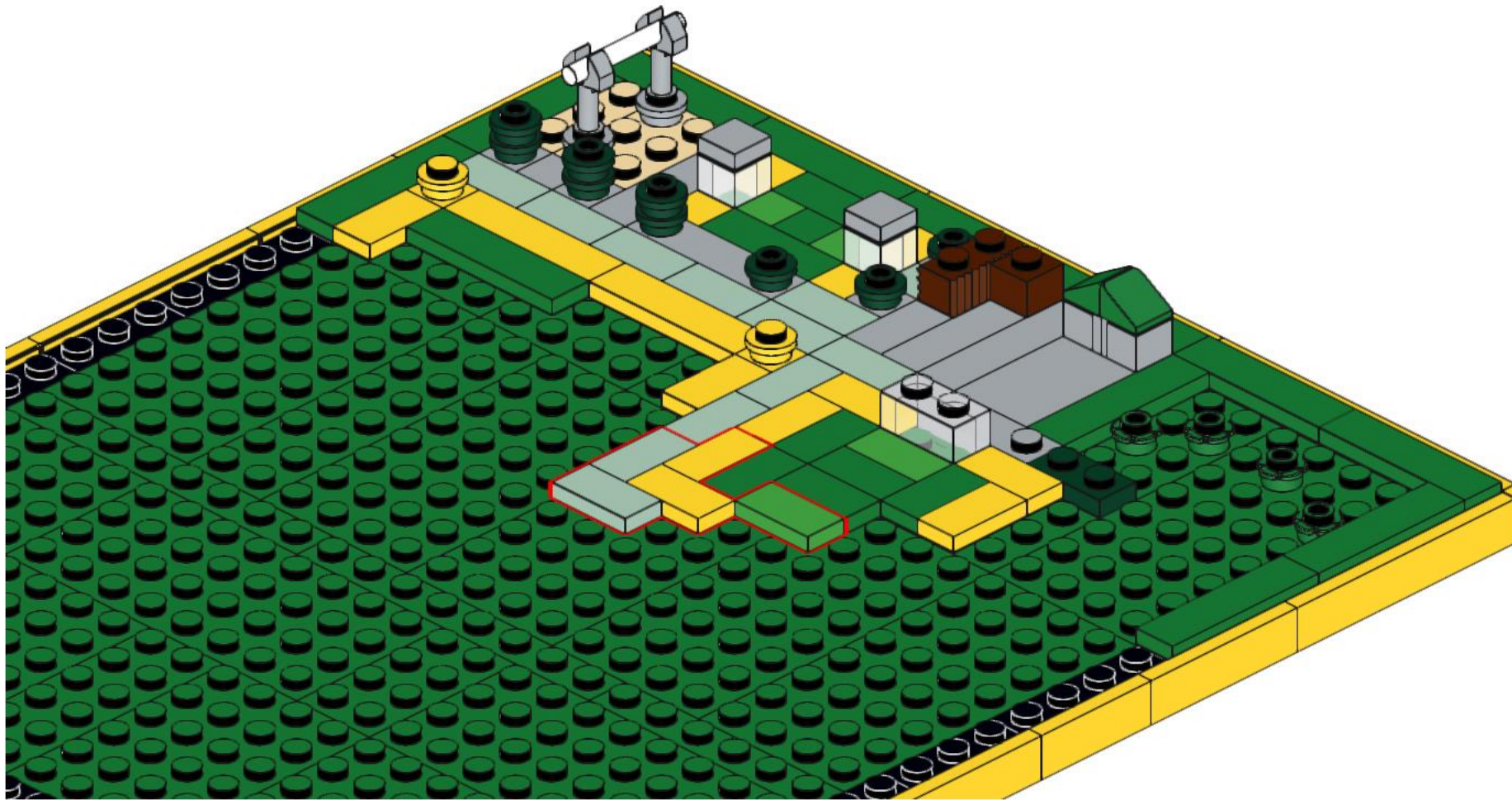
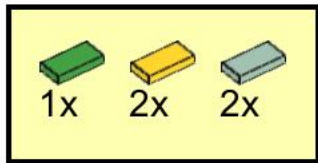

38

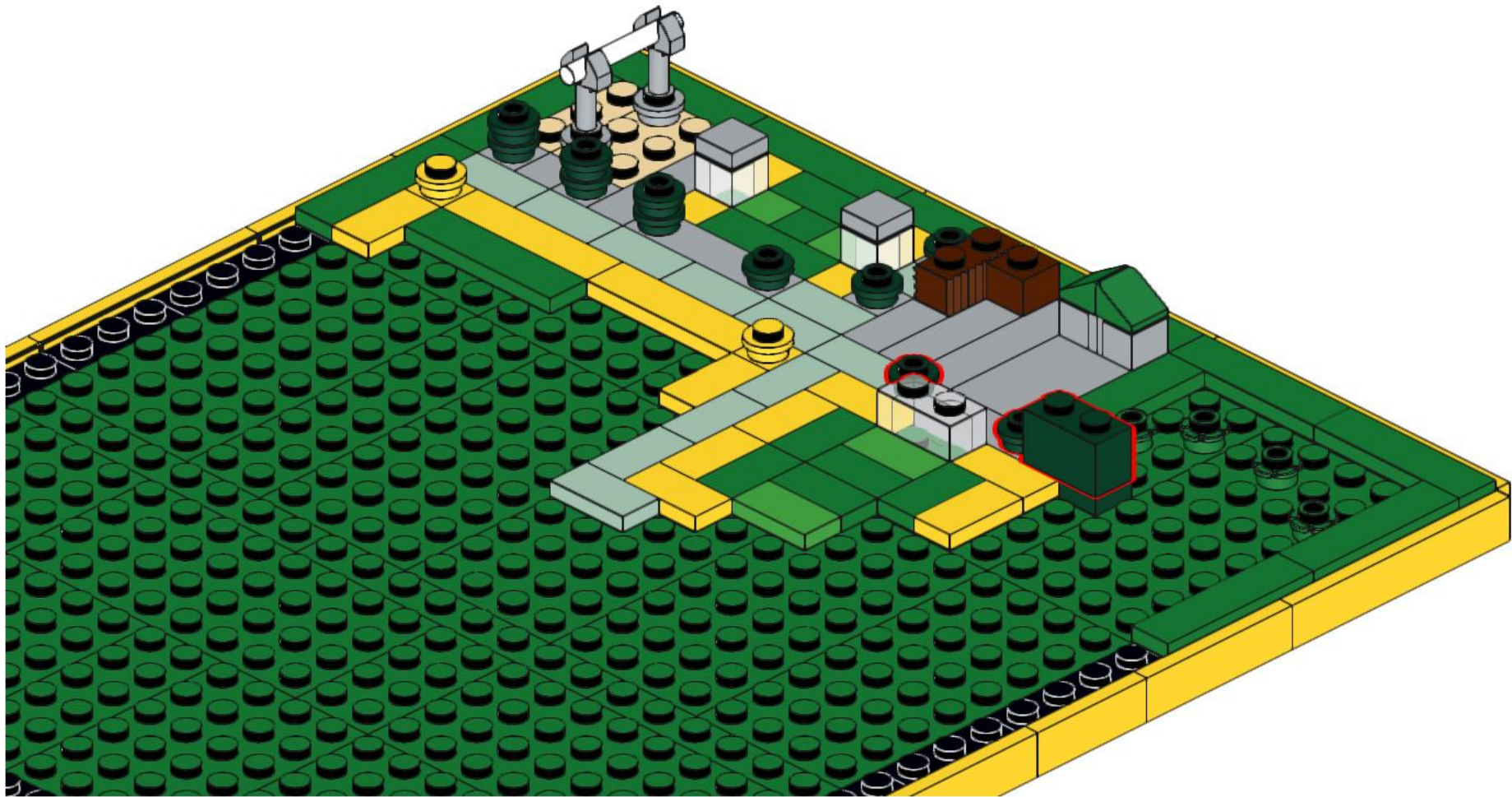
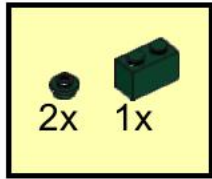

39

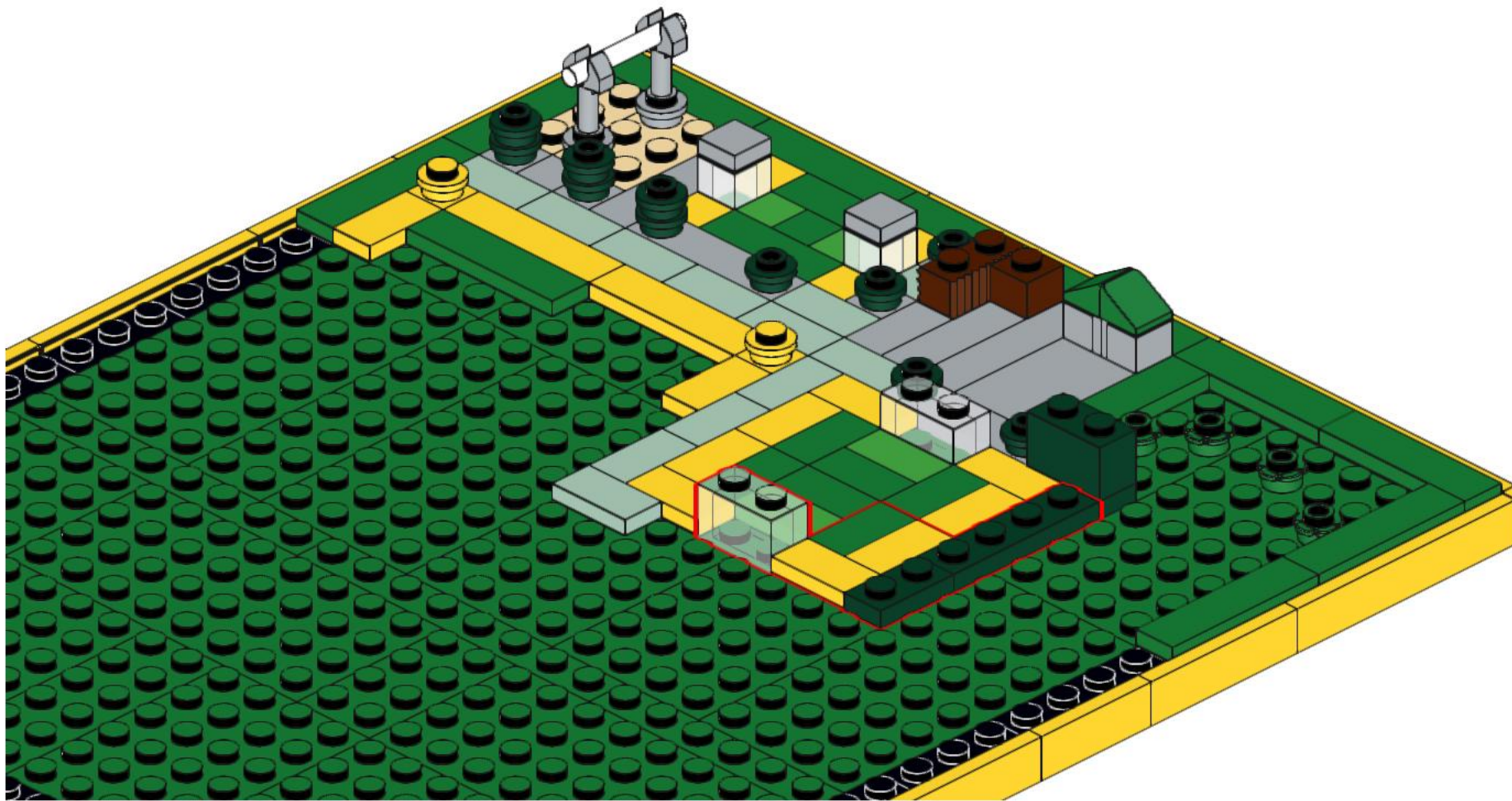
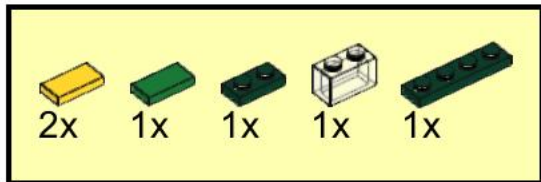

40

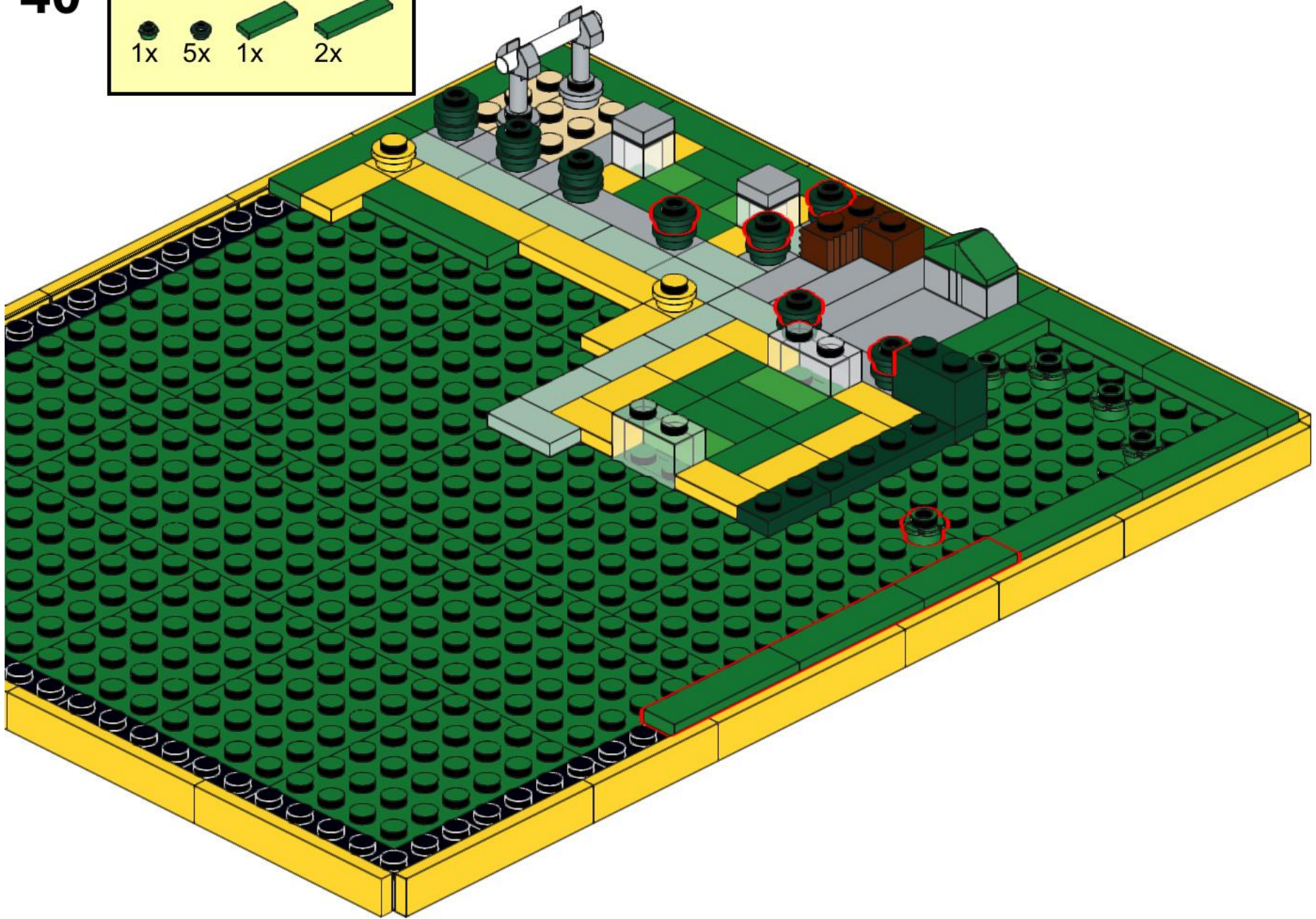
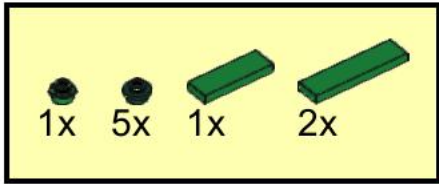

41

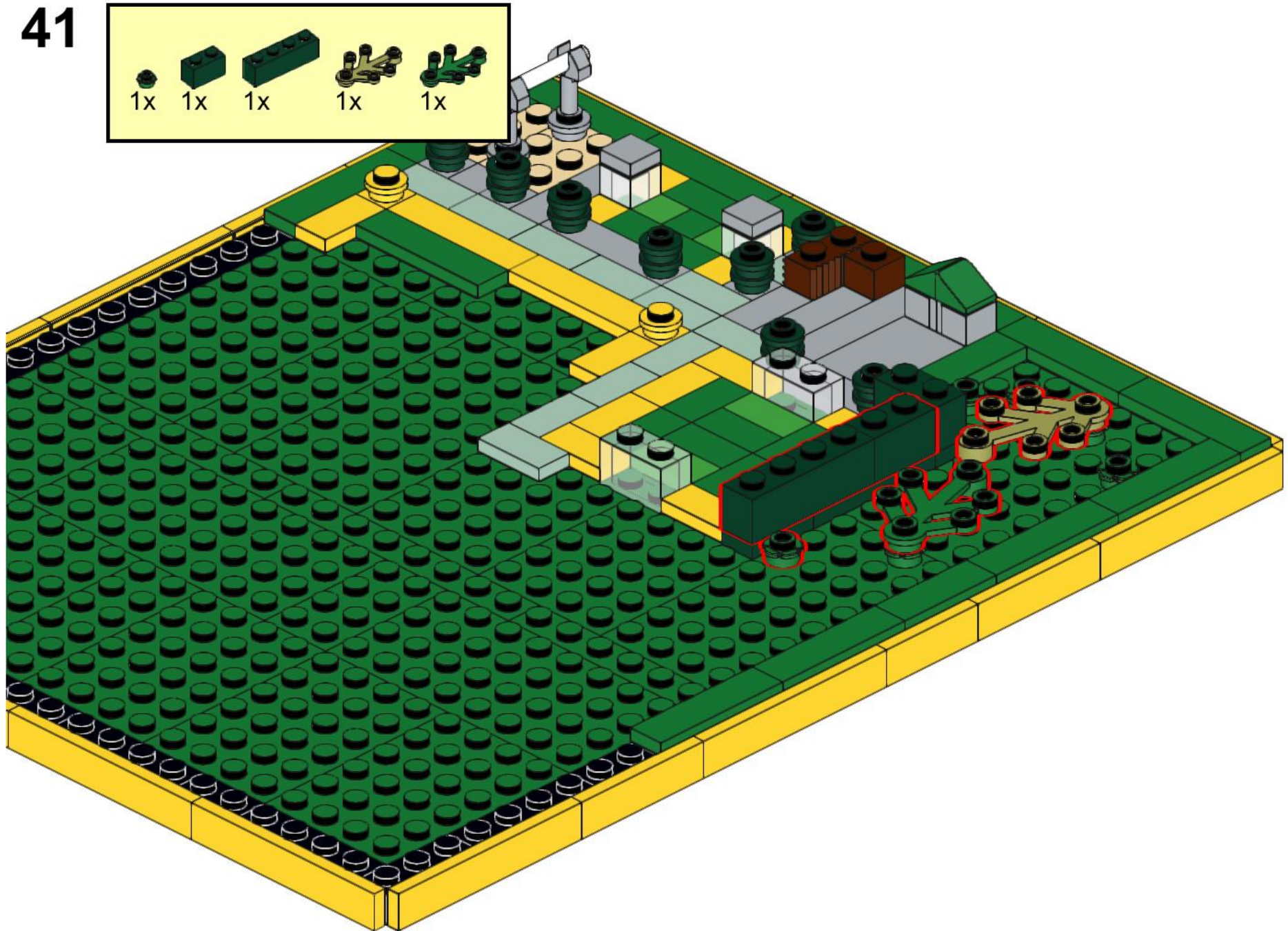
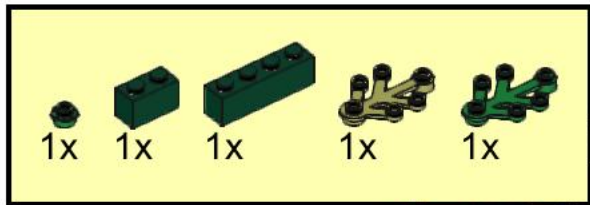

42

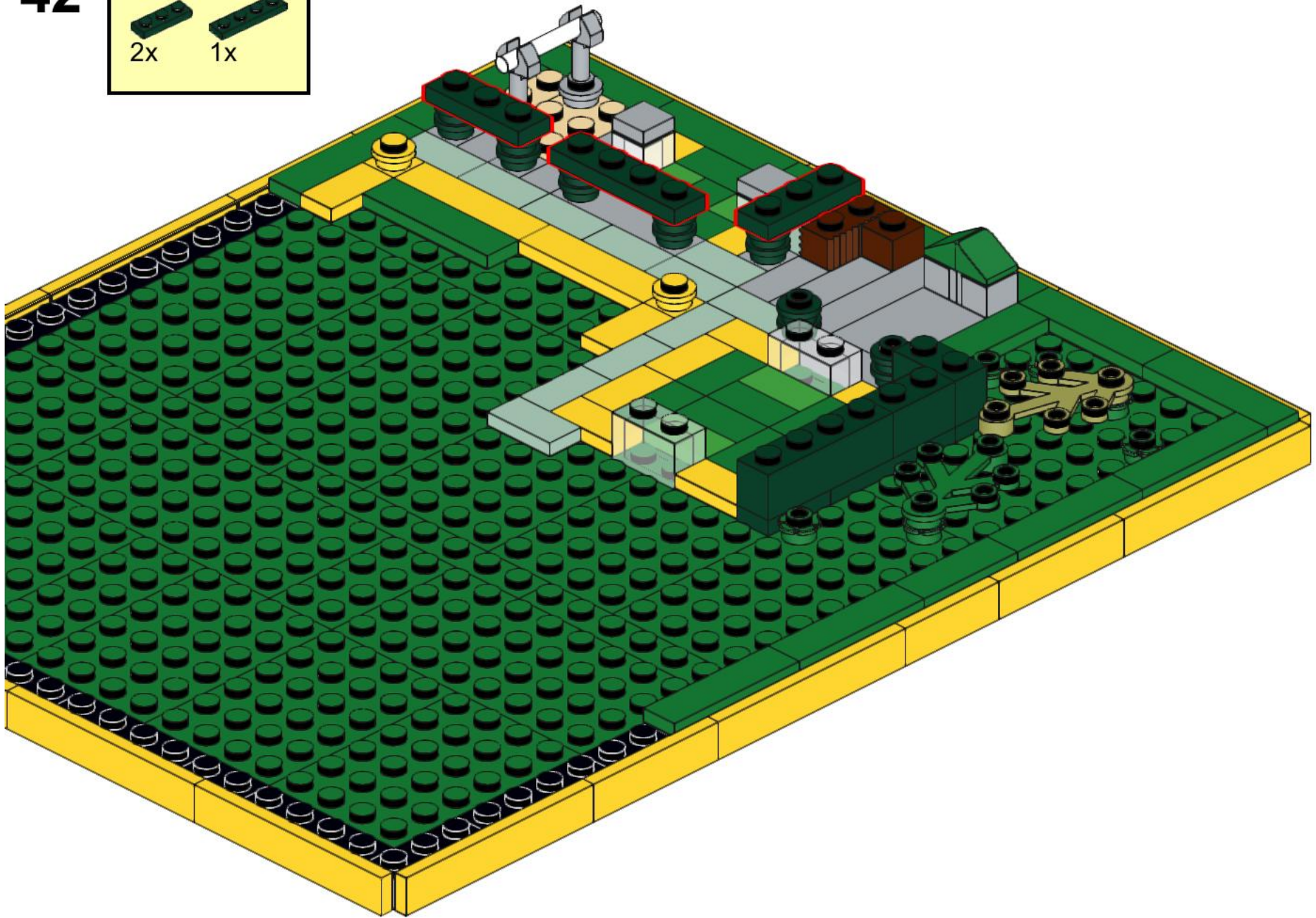
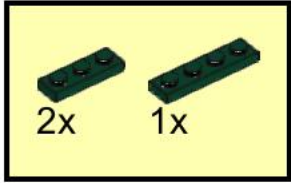

43

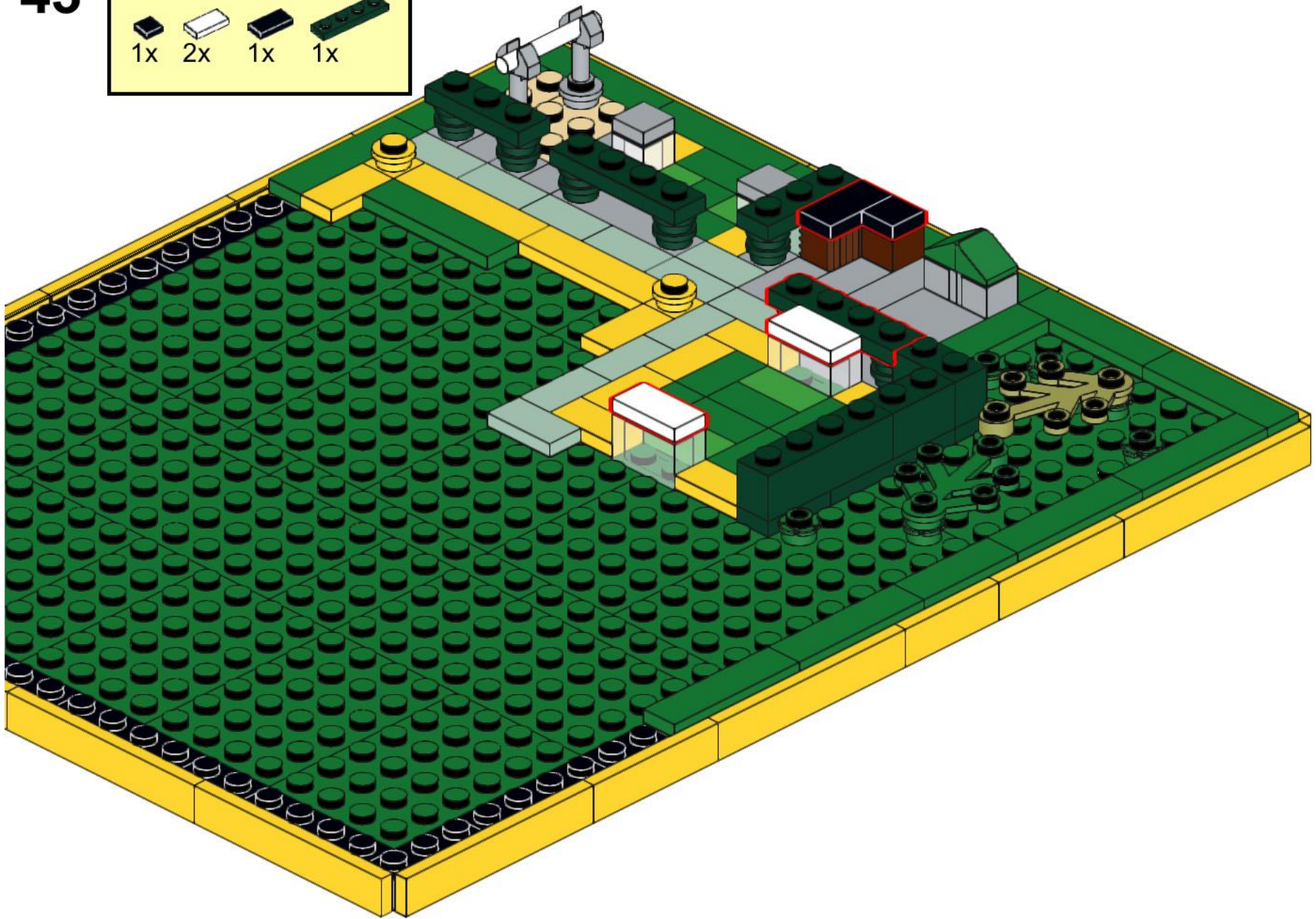
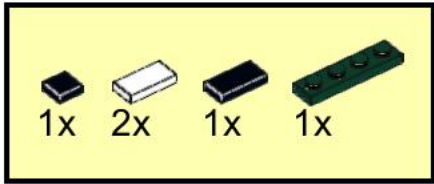

44

1x 1x 1x 1x 1x 1x

This inset box lists the parts required for step 44. It contains six items, each labeled '1x': a yellow 1x2 Technic brick, a green 1x2 Technic brick, a green 1x3 Technic brick, a white 1x2 Technic brick with a hole, a green 1x4 Technic brick, and a white 1x2 Technic window with black studs.

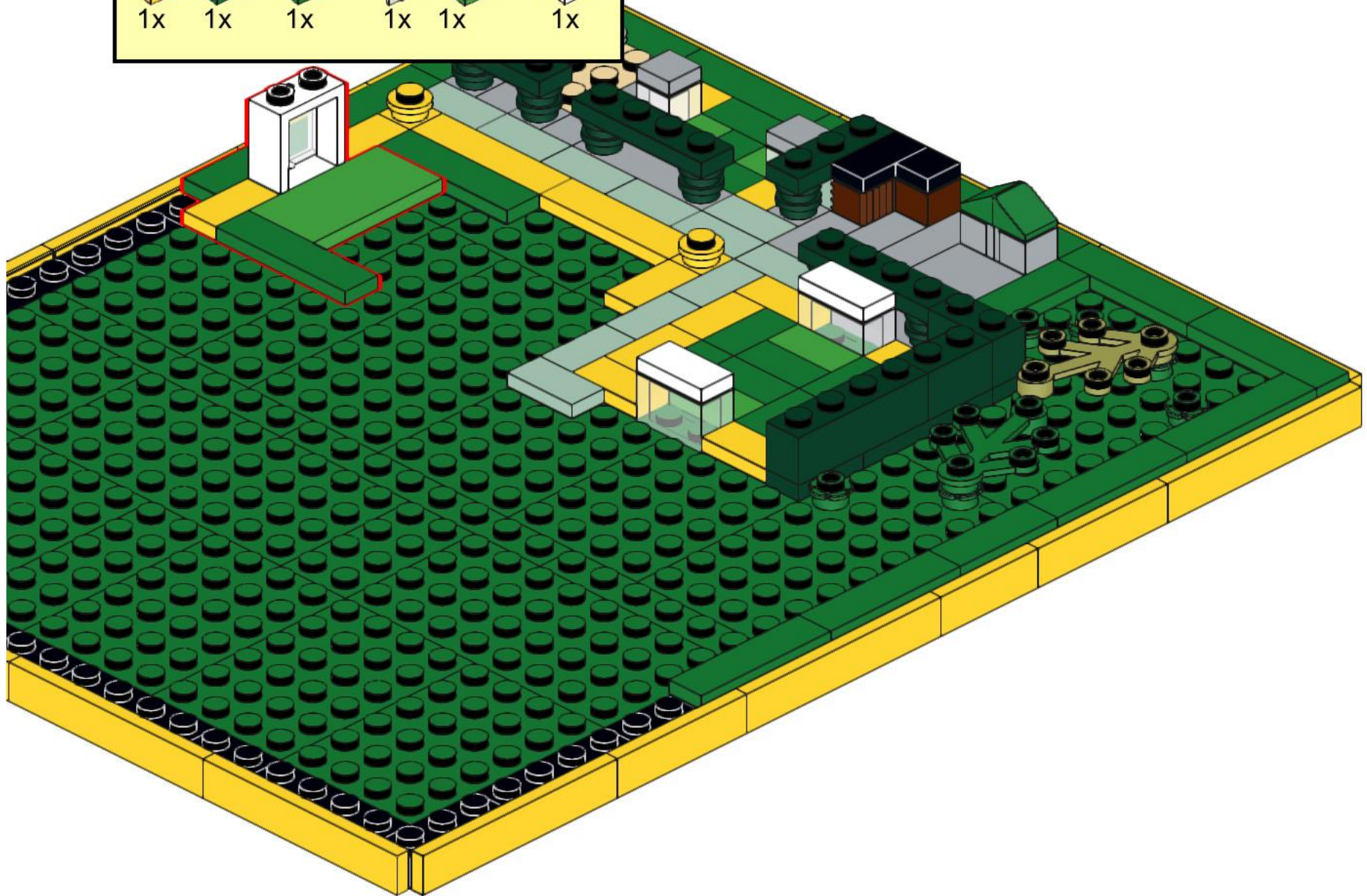



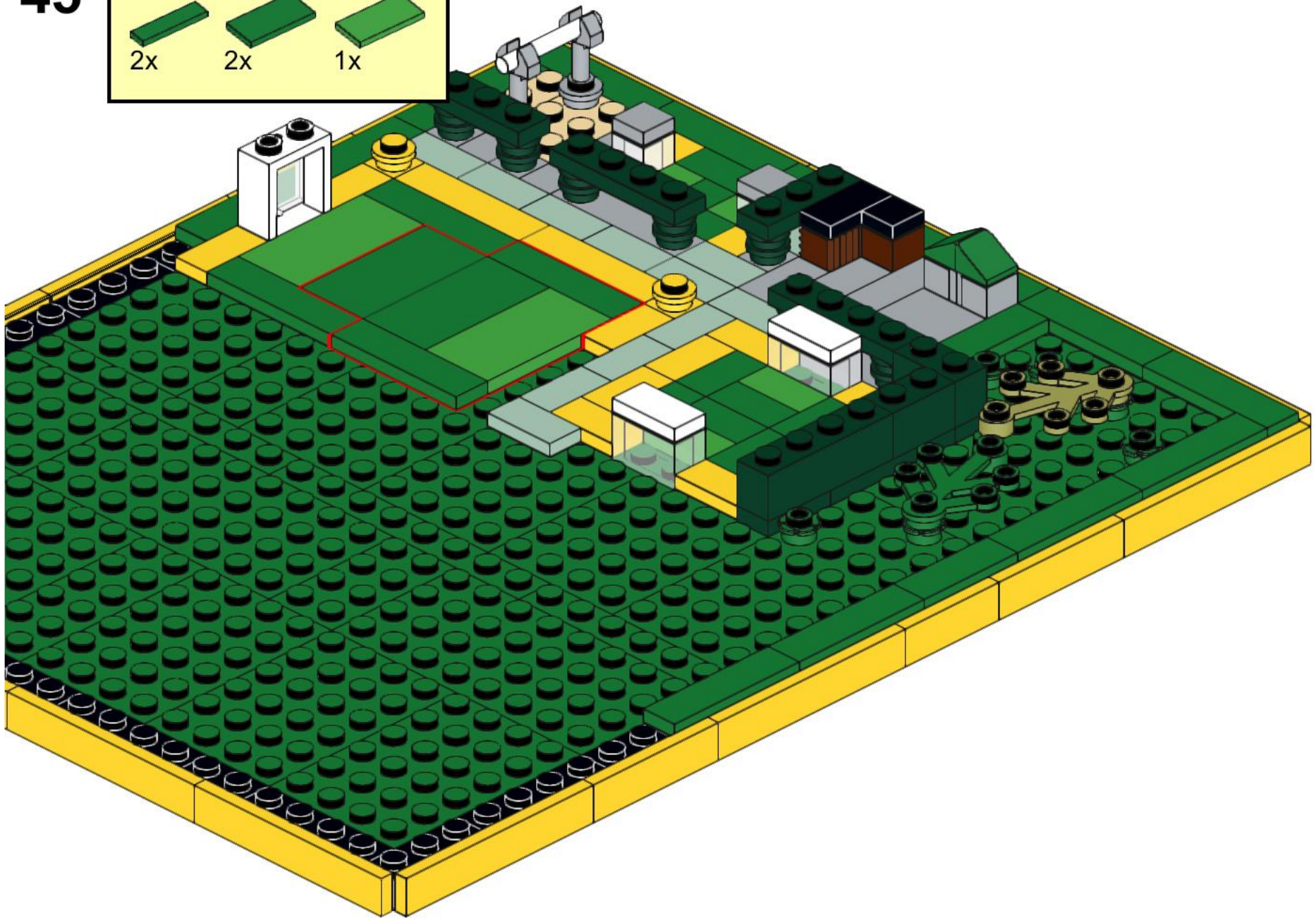
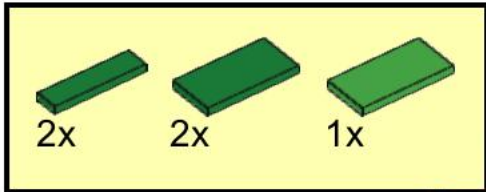



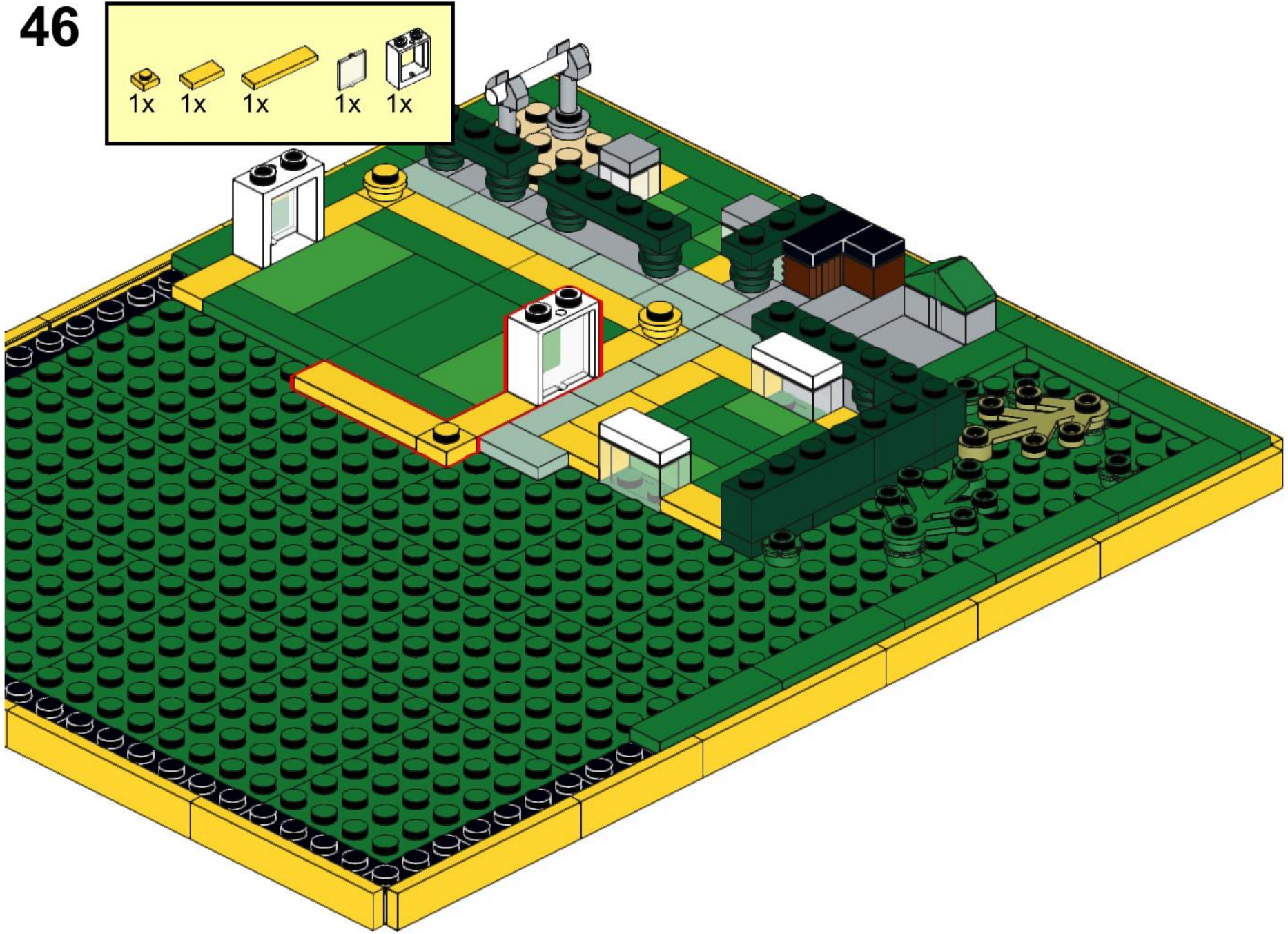
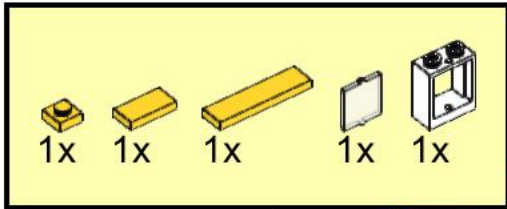

45



46





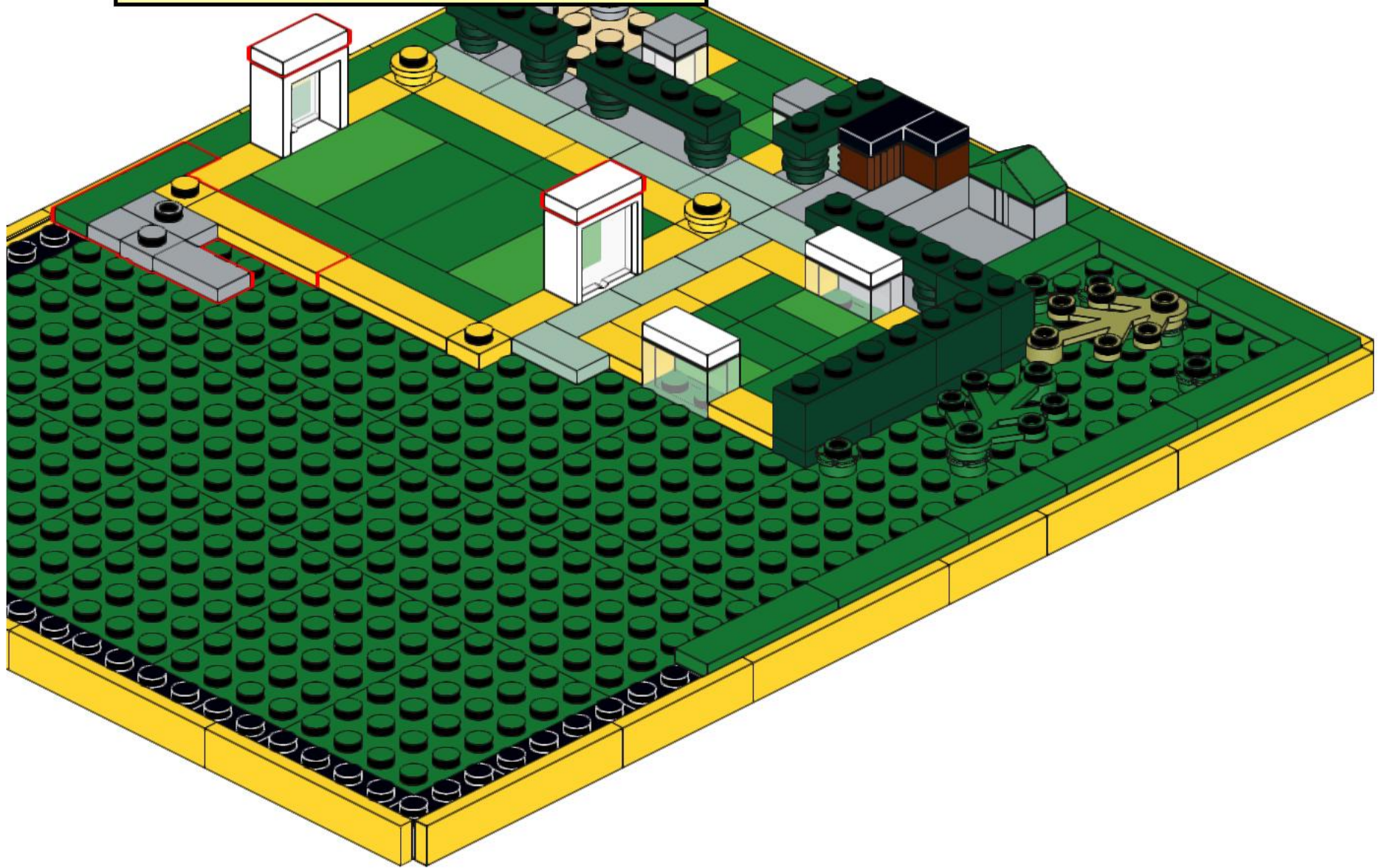

47

							
1x	1x	1x	1x	2x	1x	1x	1x



48

				
2x	2x	2x	1x	2x

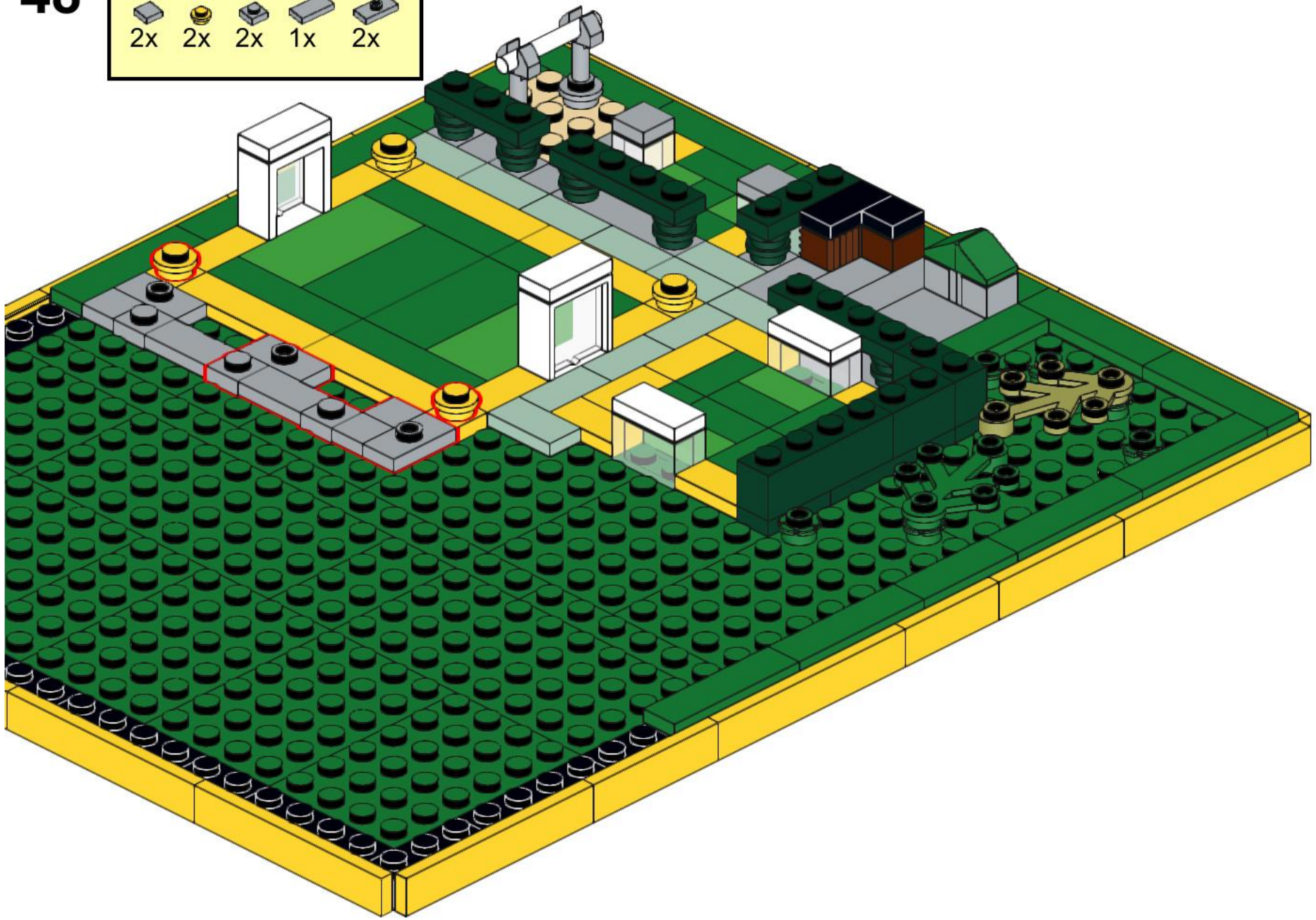

49

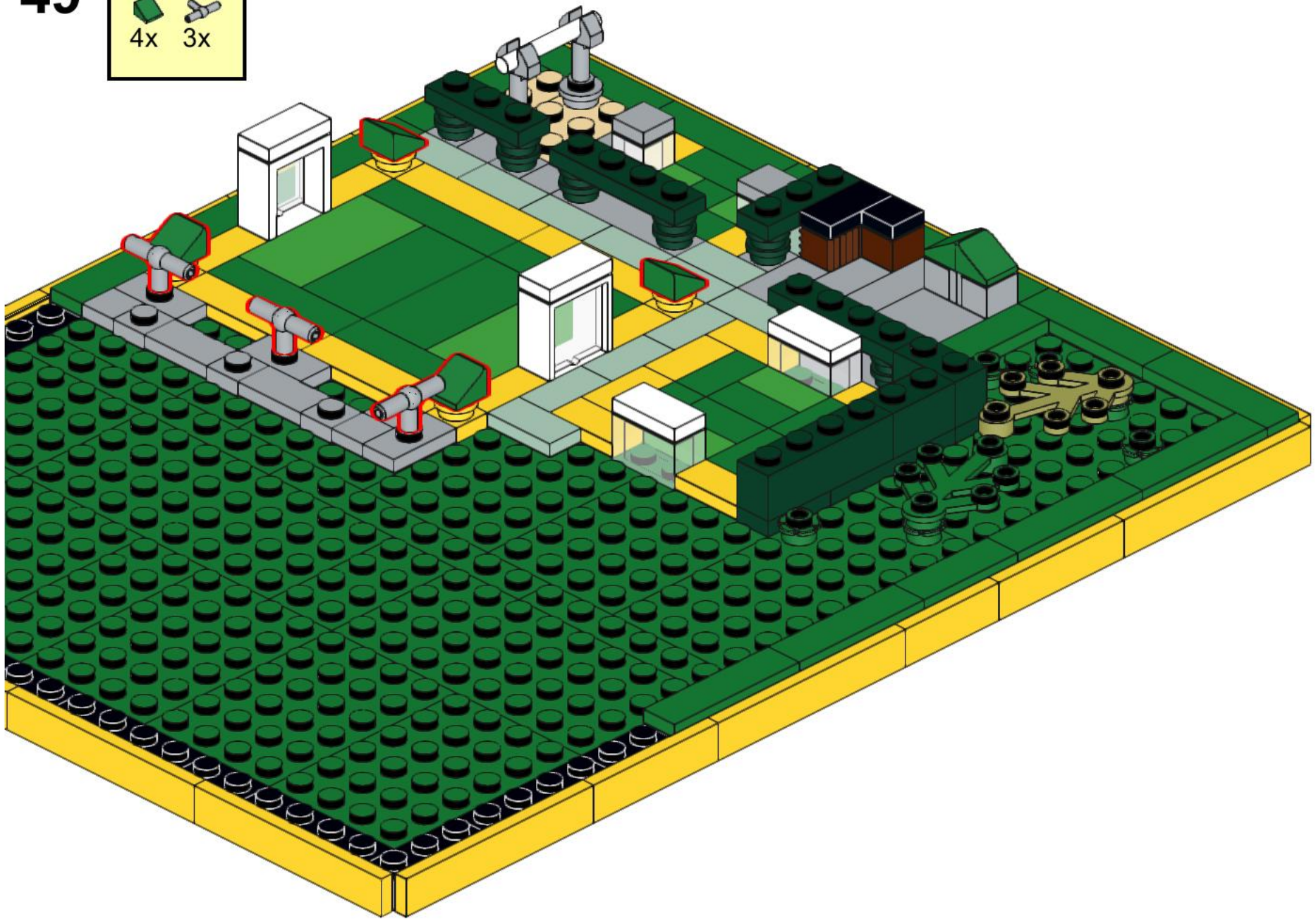
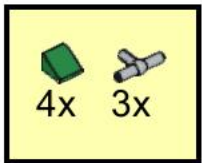

50

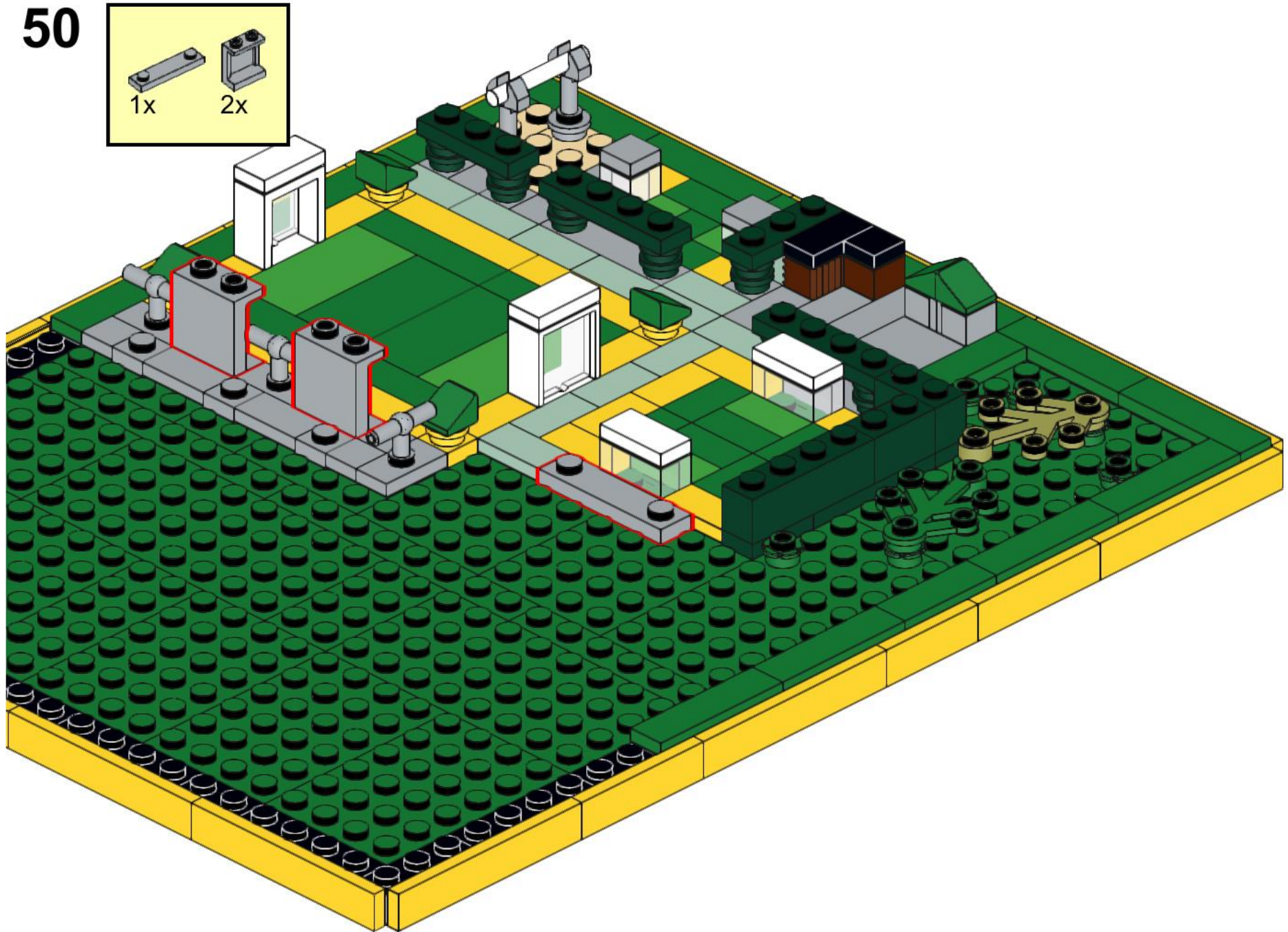
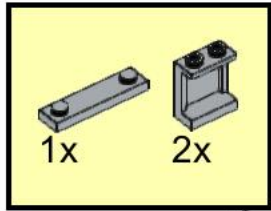

51

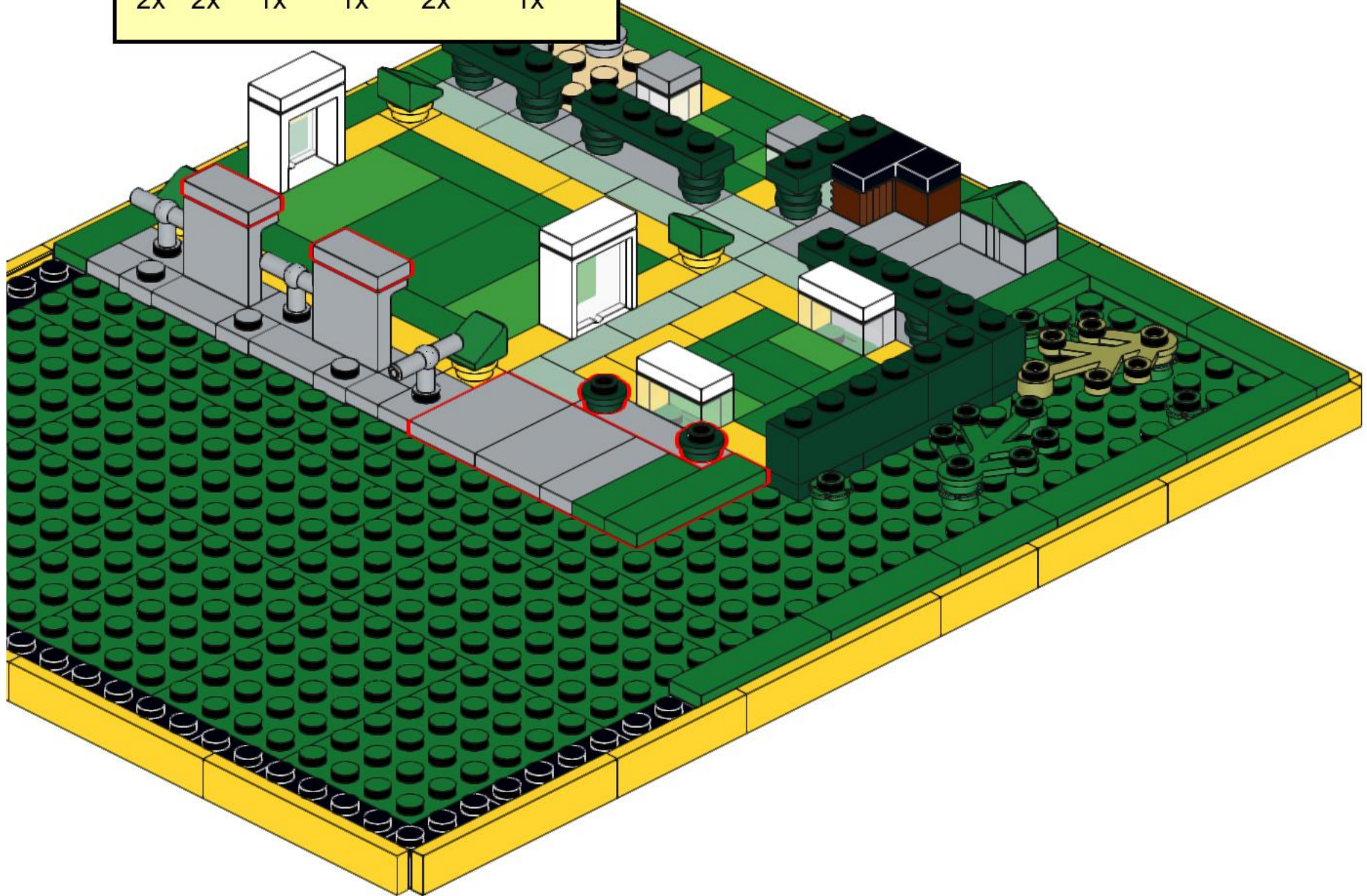
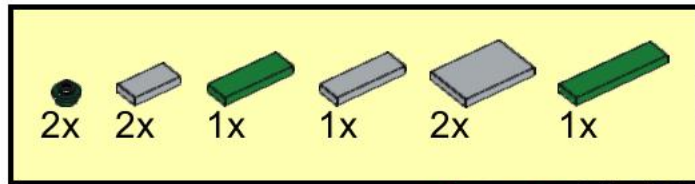

3

52

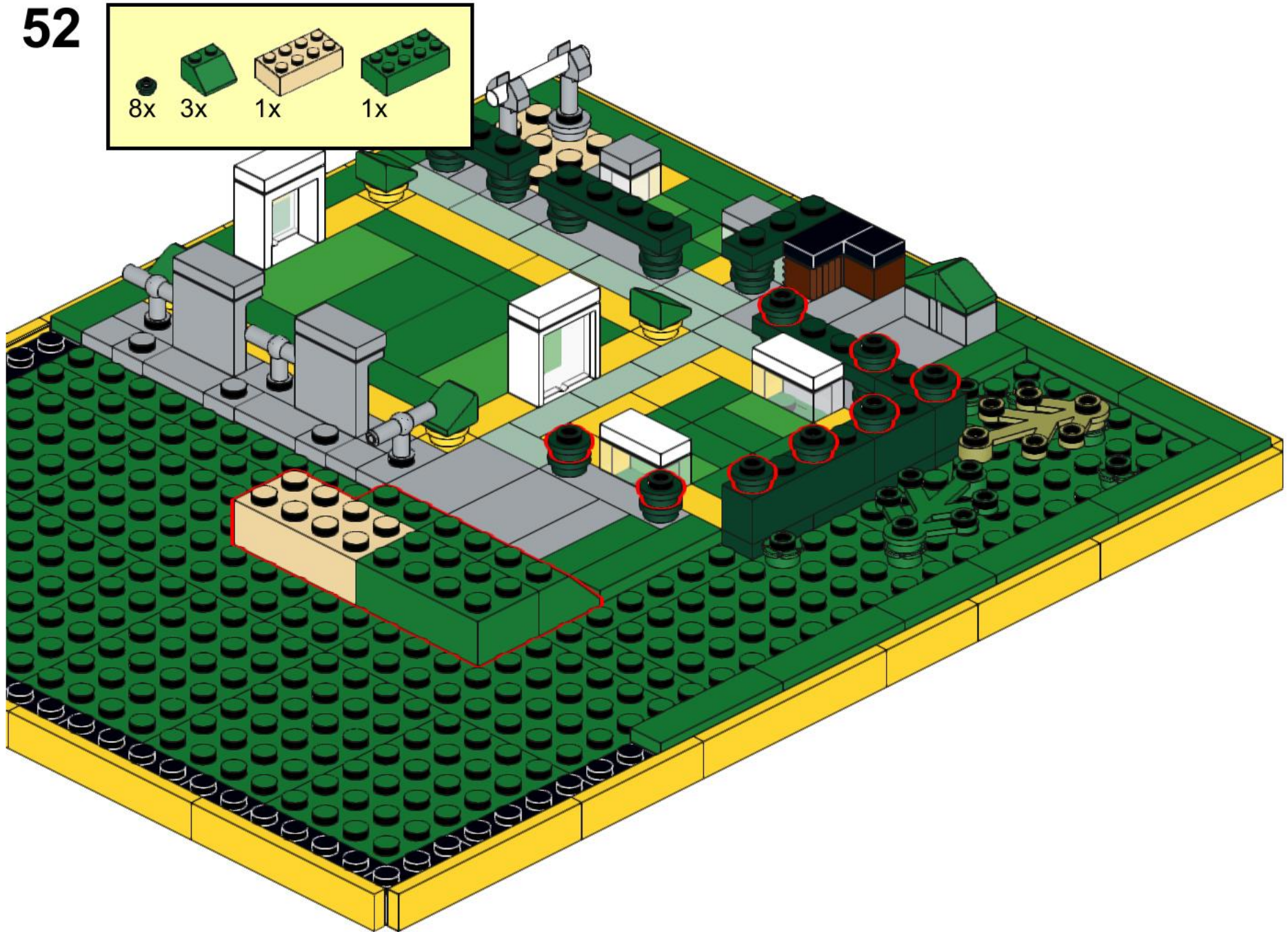
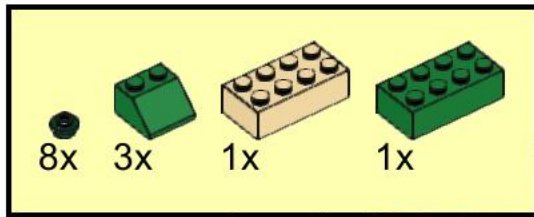

53

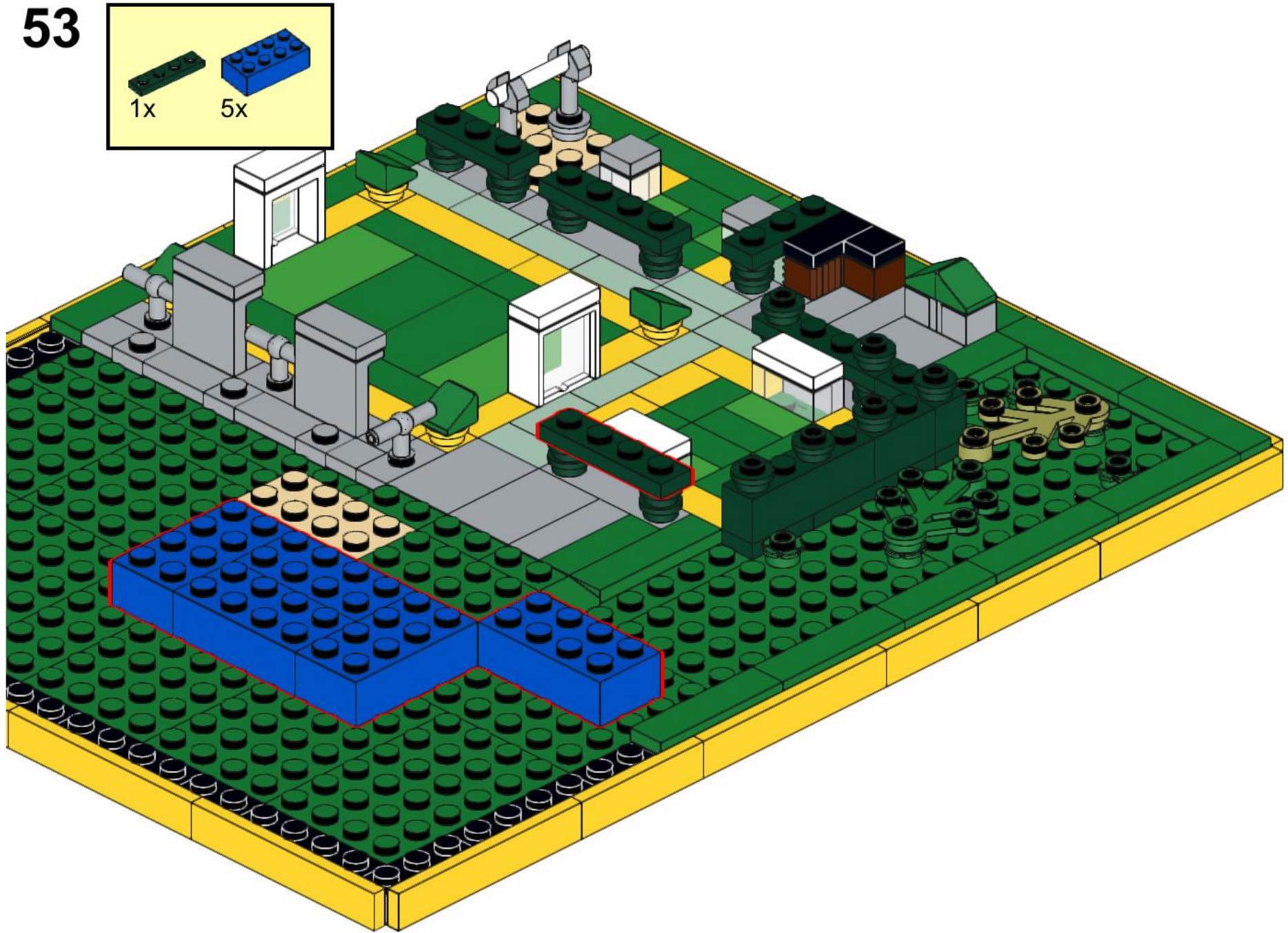
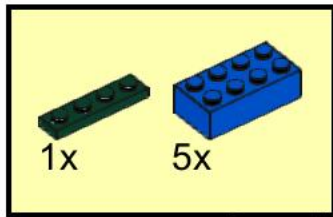

54

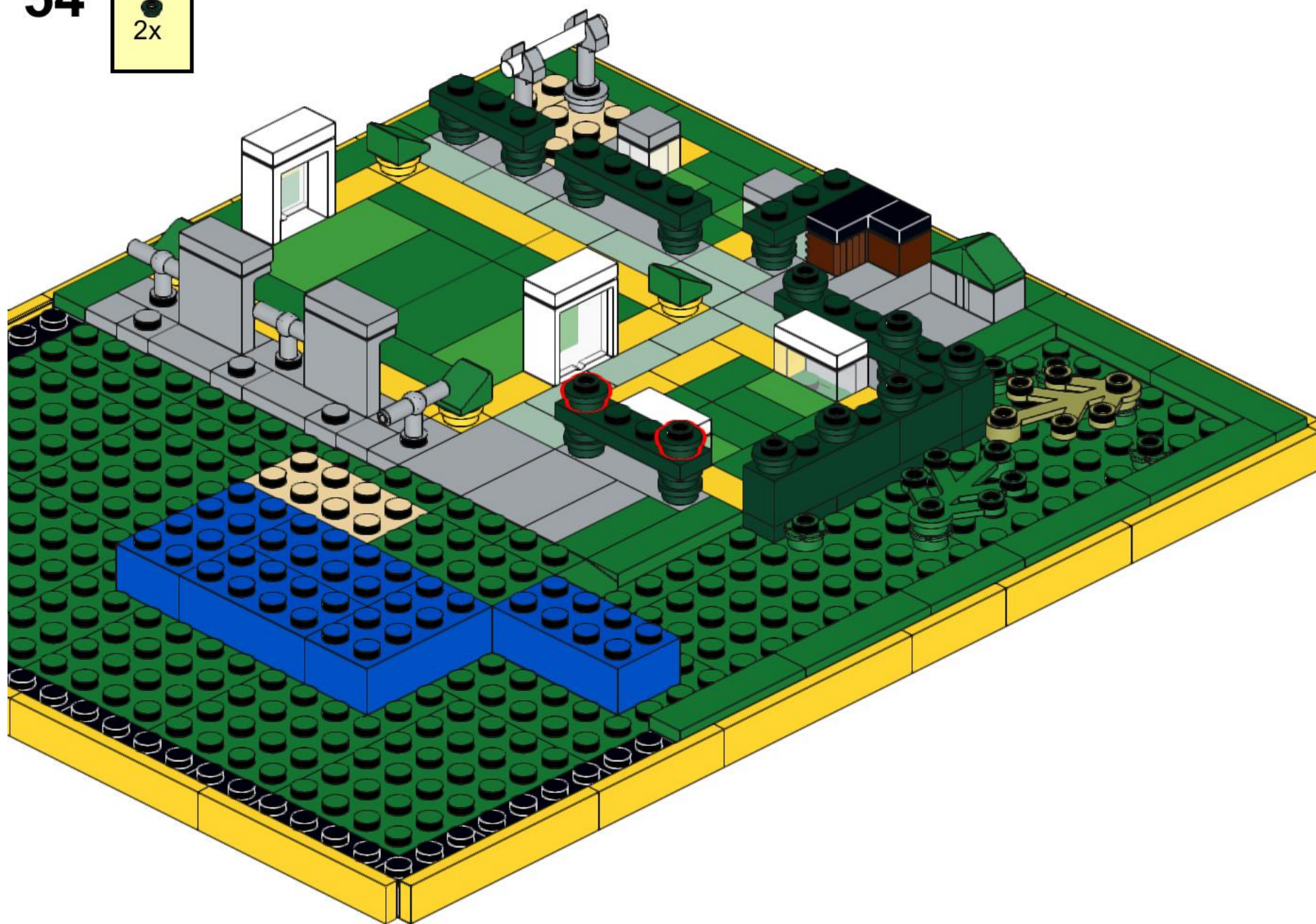

55

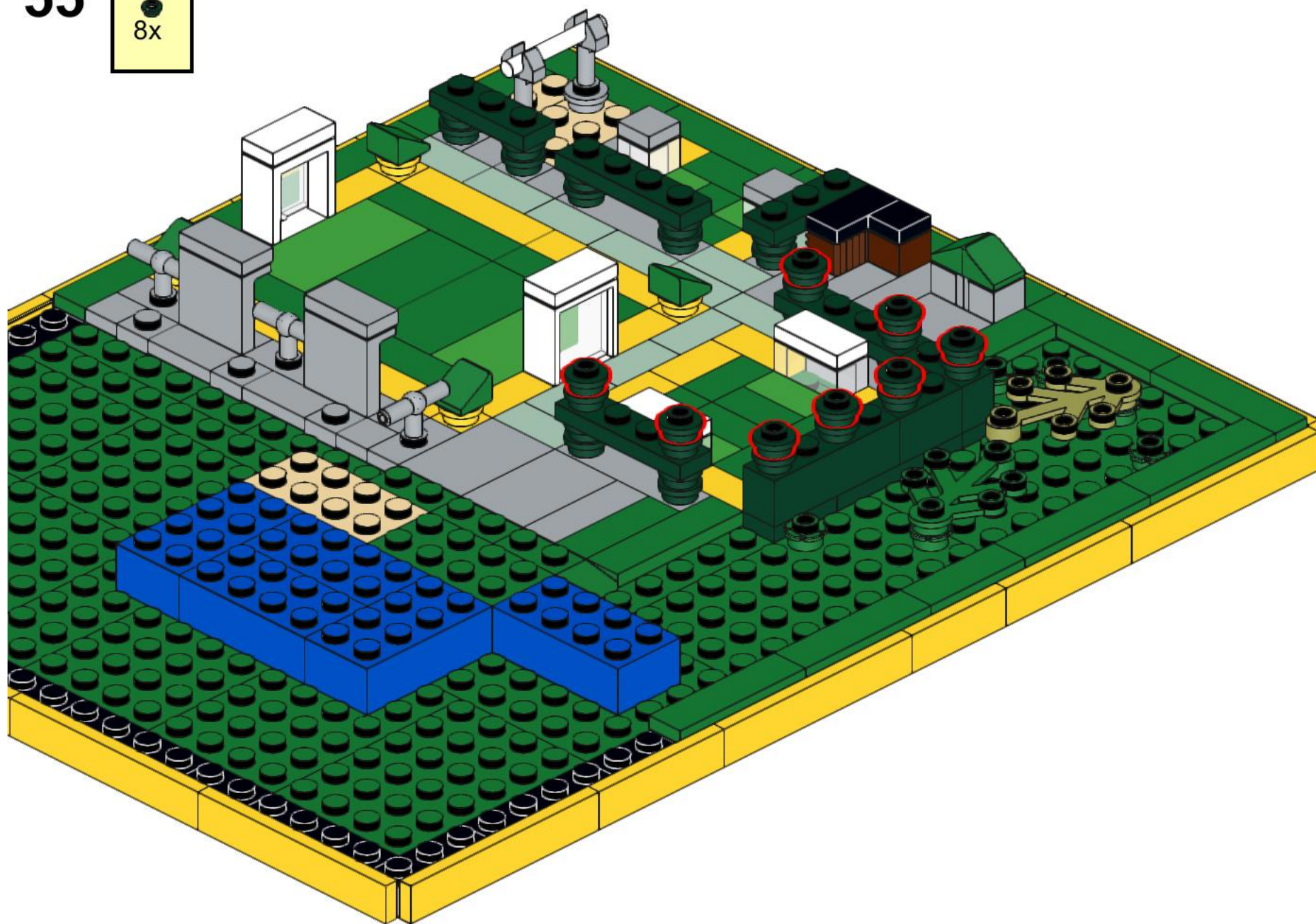
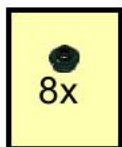

56

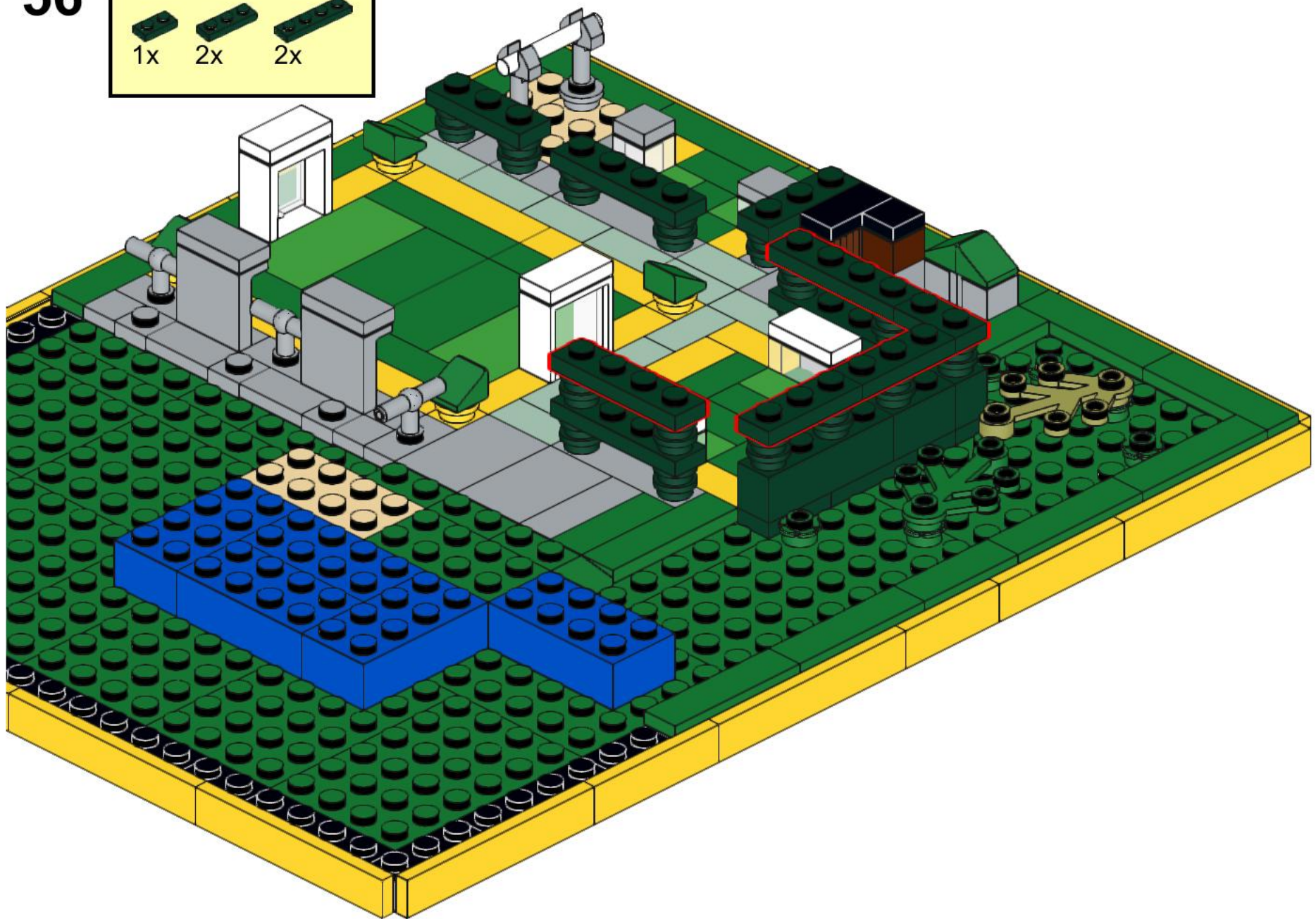
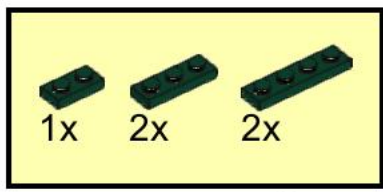

57

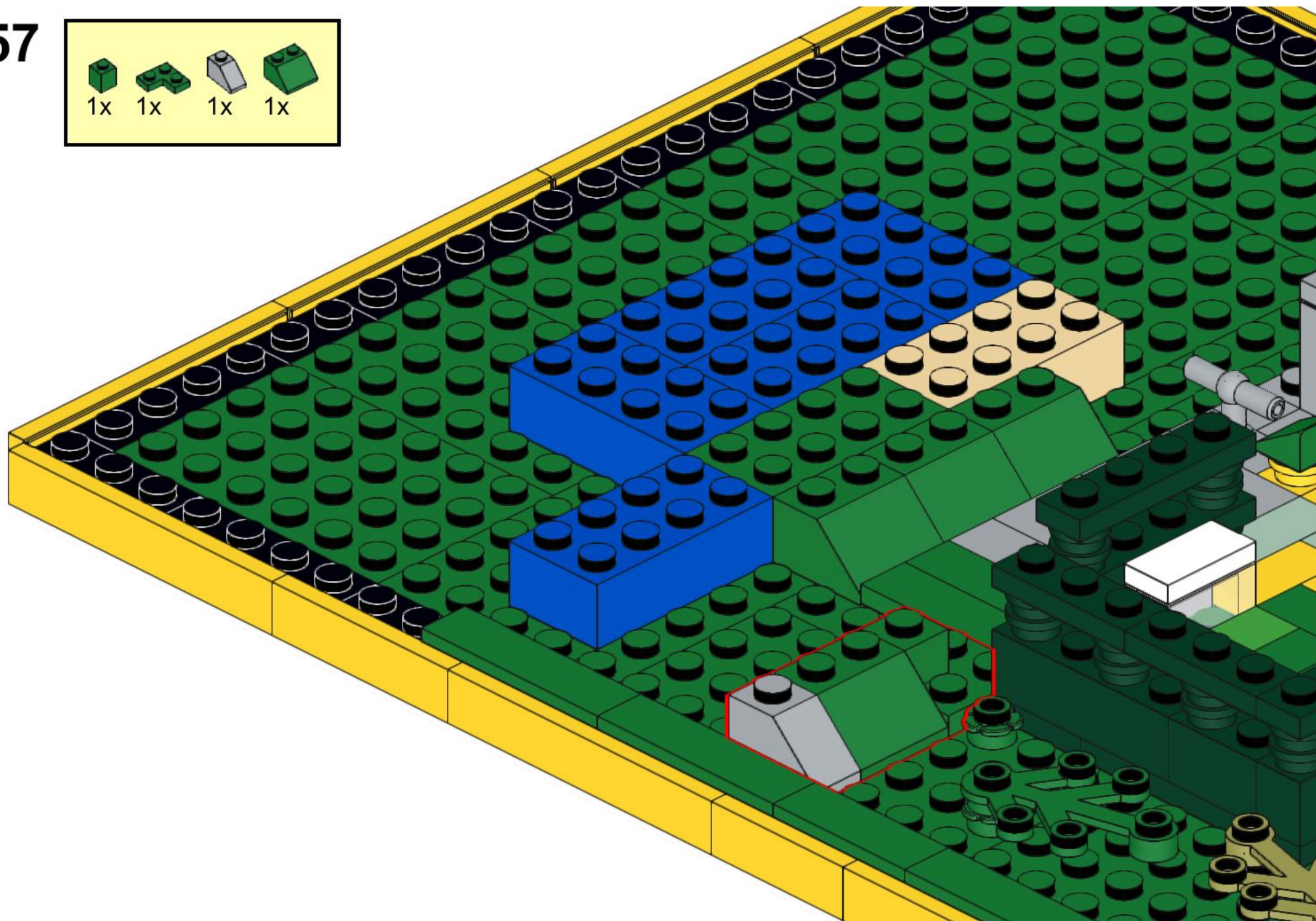
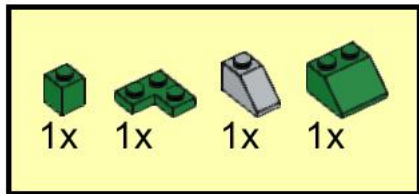

58

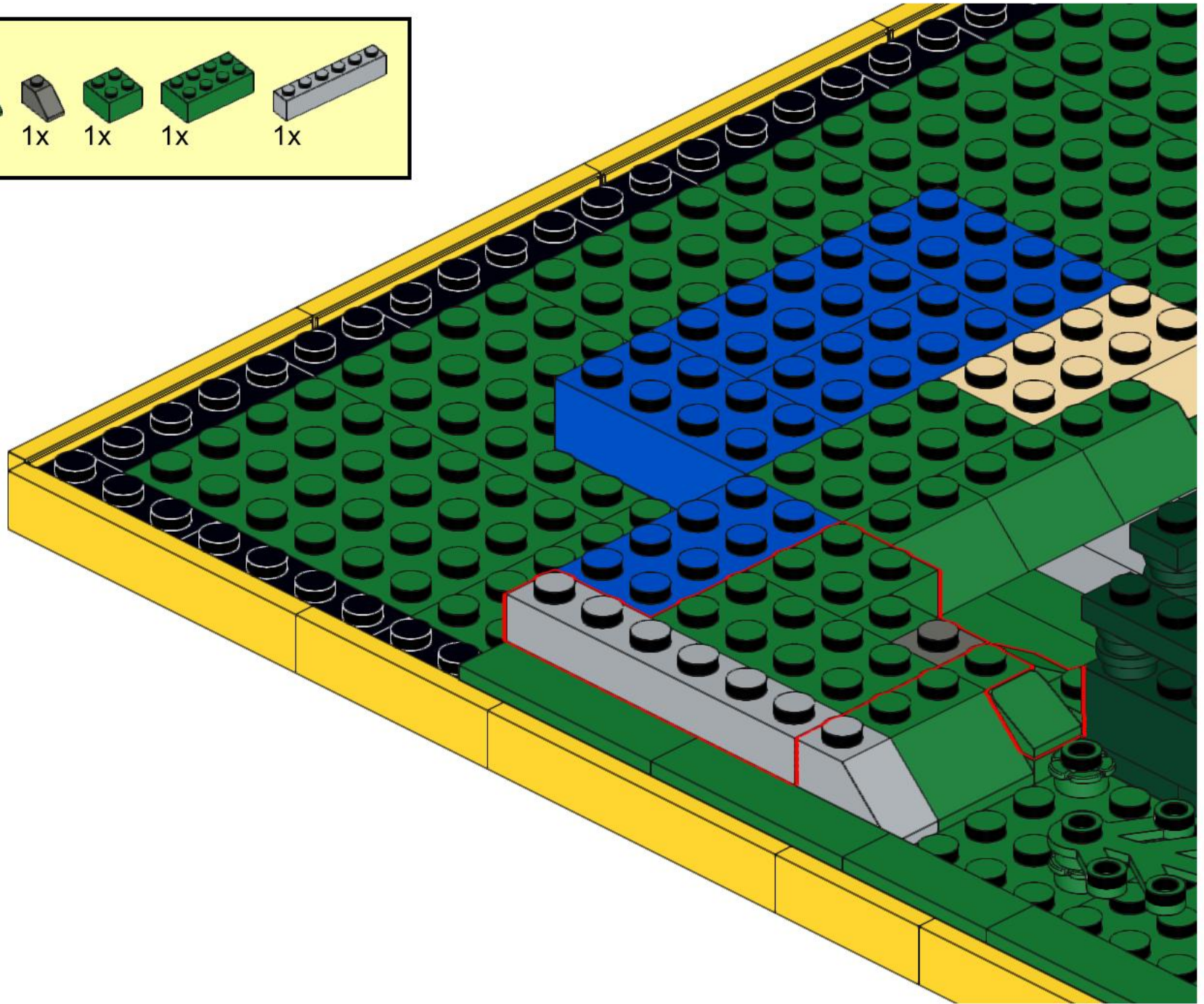
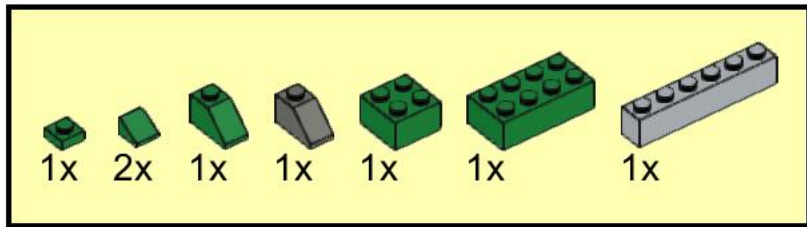

59

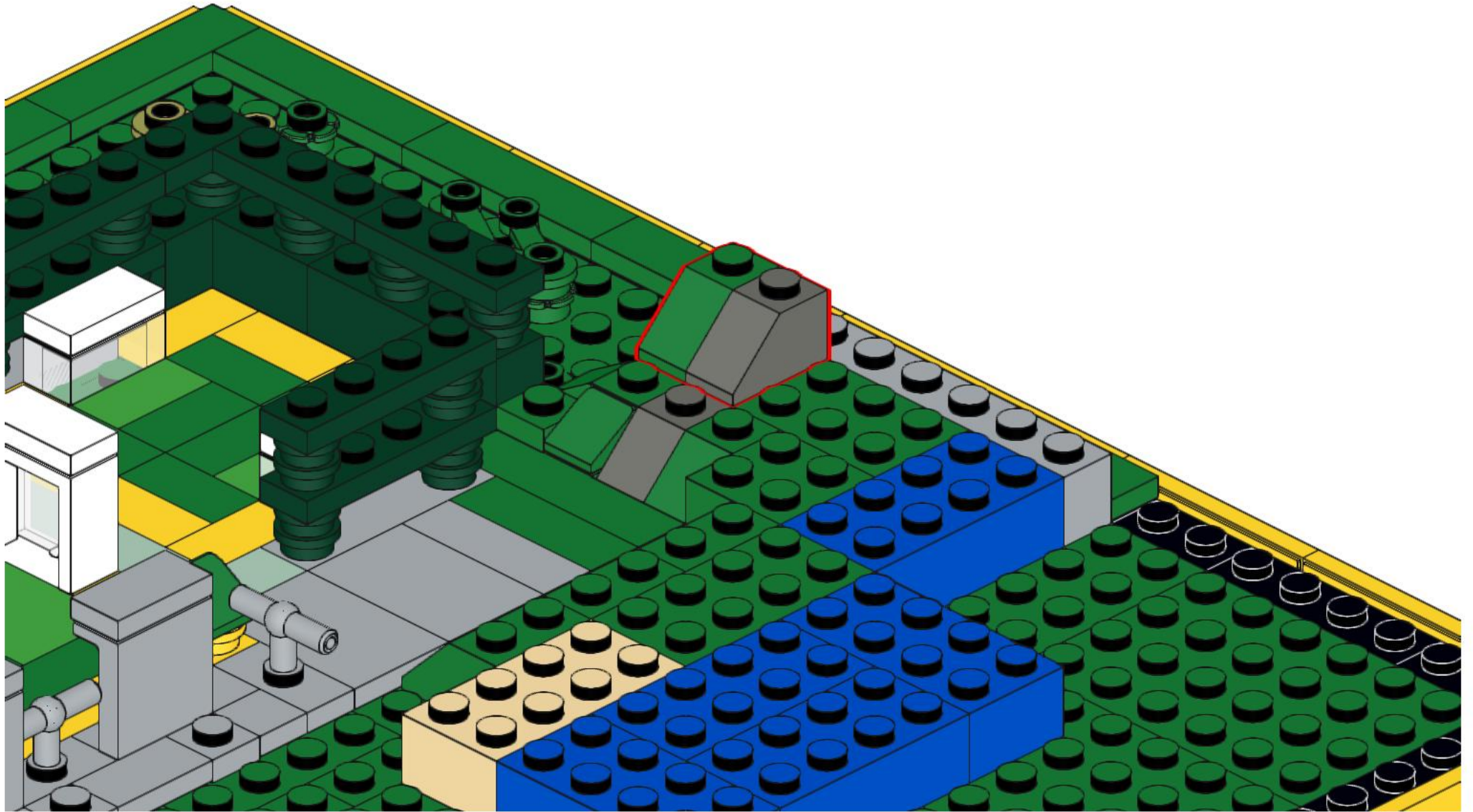
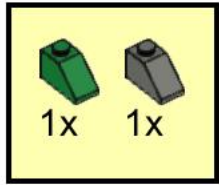

60

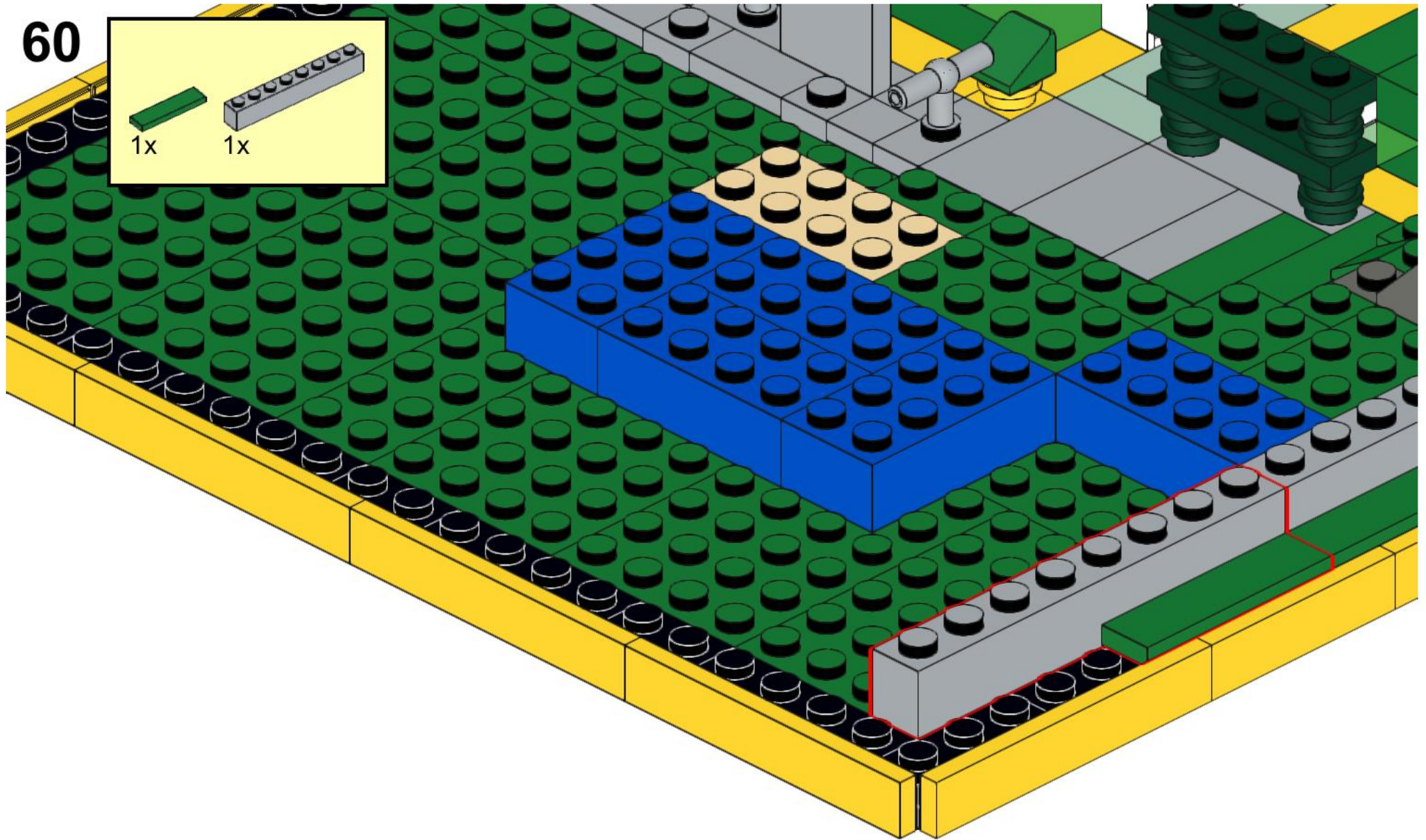
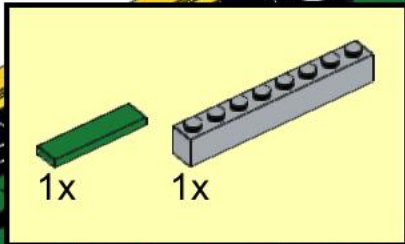

61

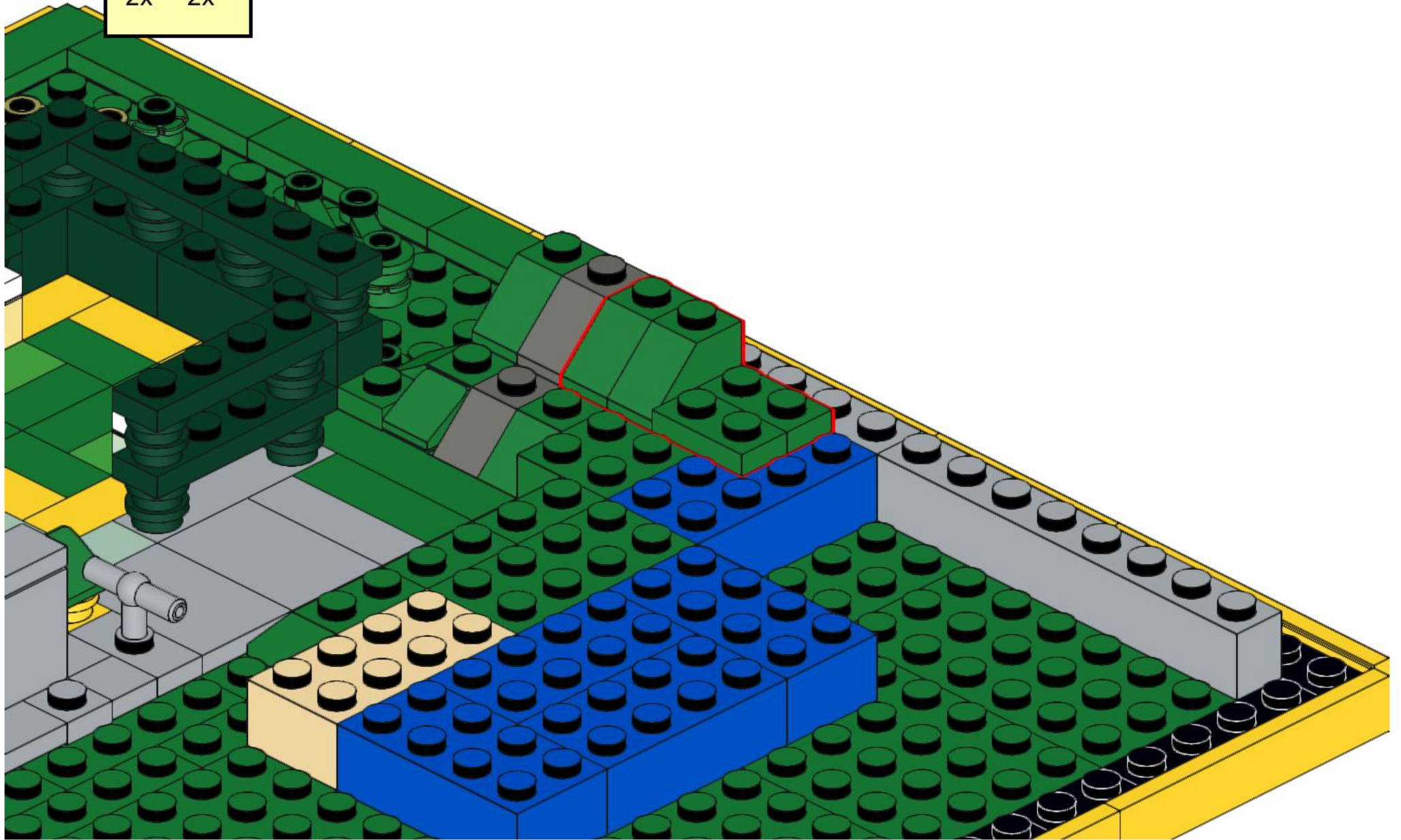
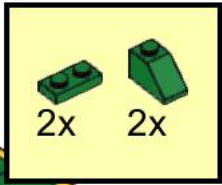

62

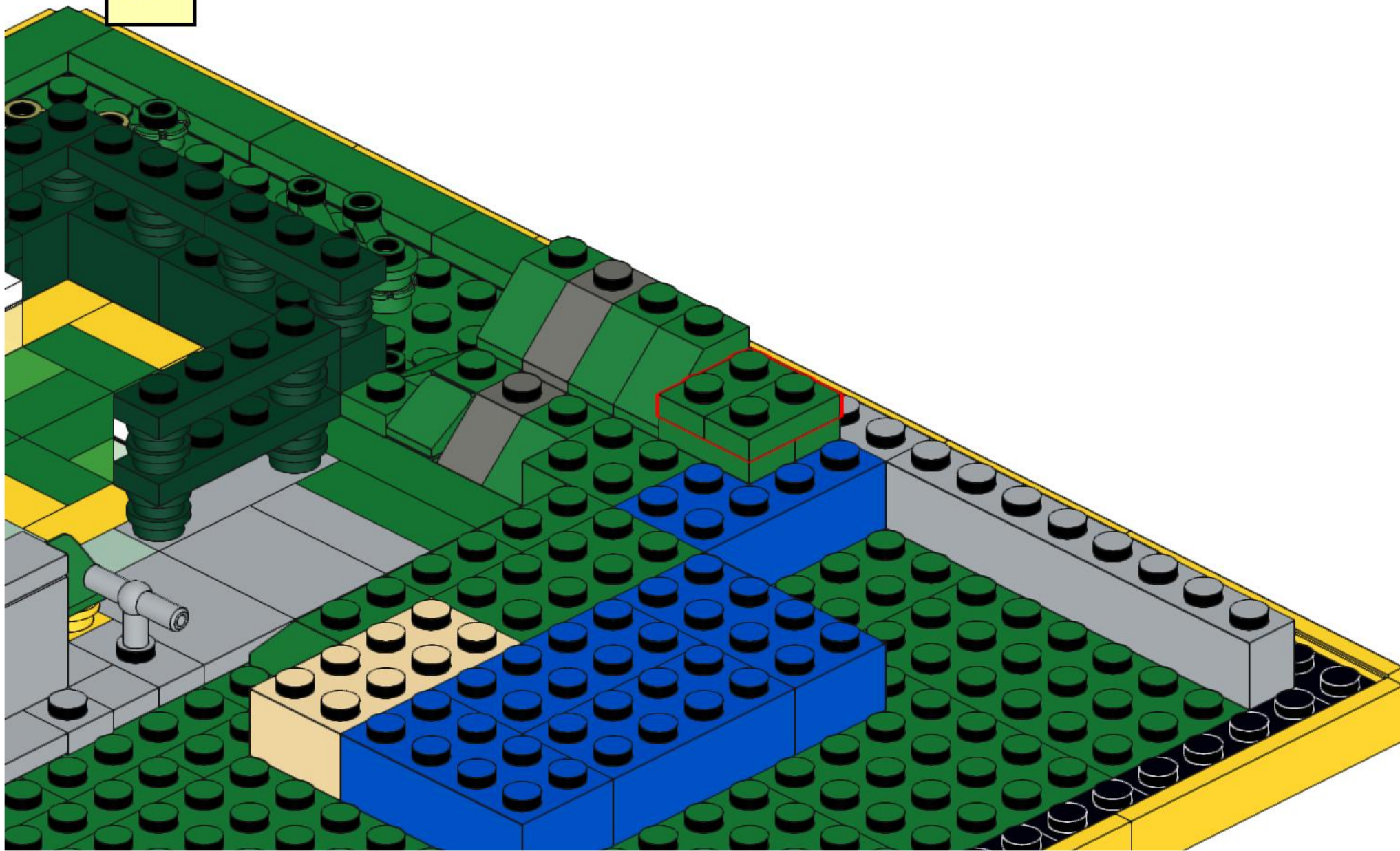
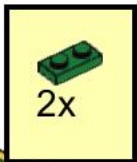

63

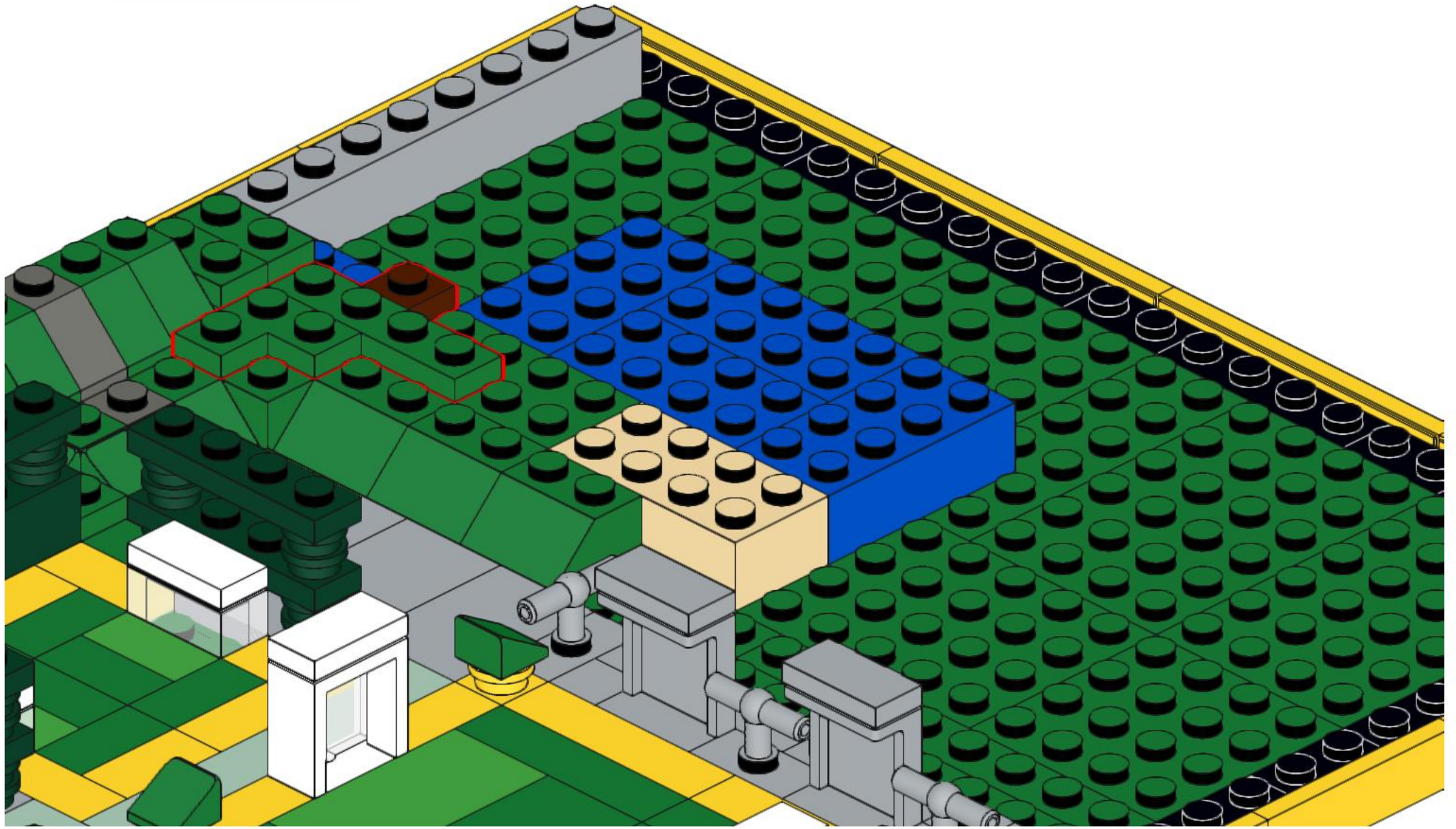
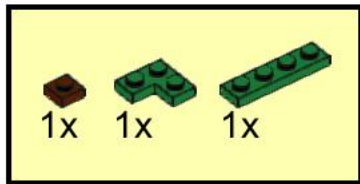

64

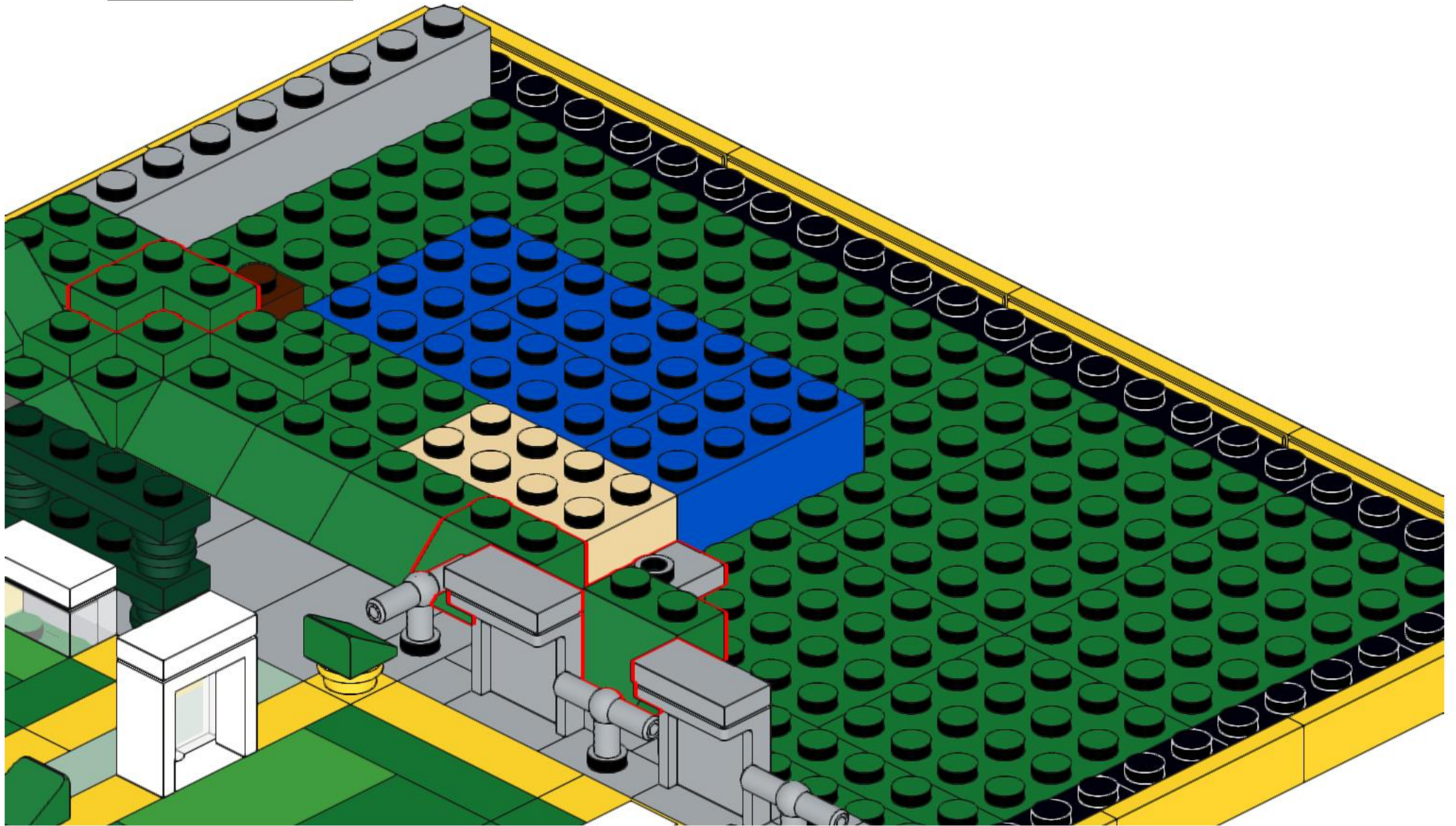
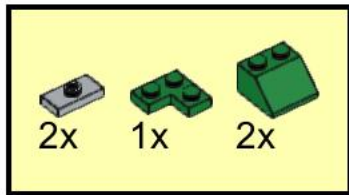

65

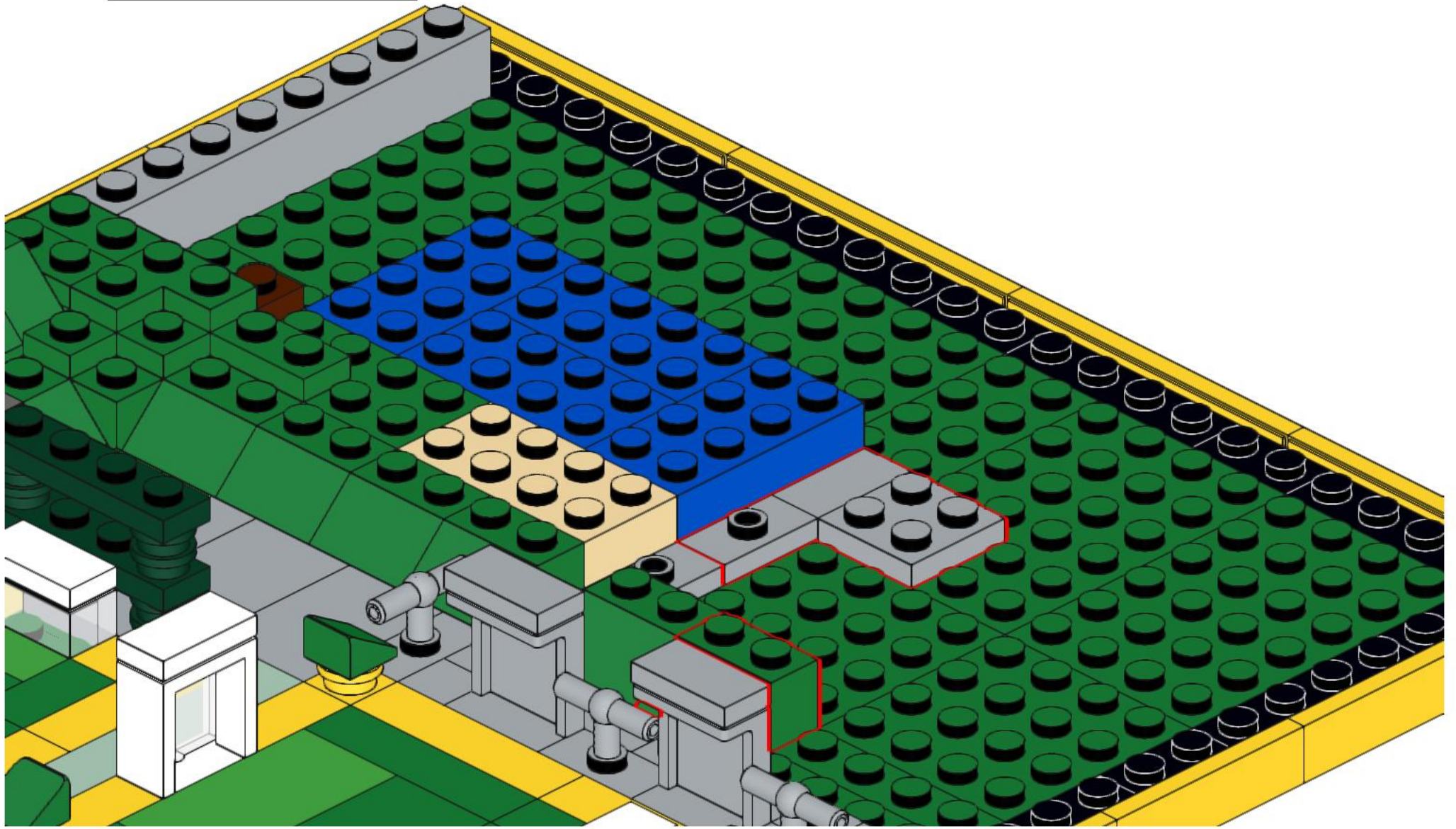
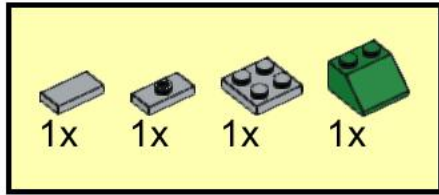

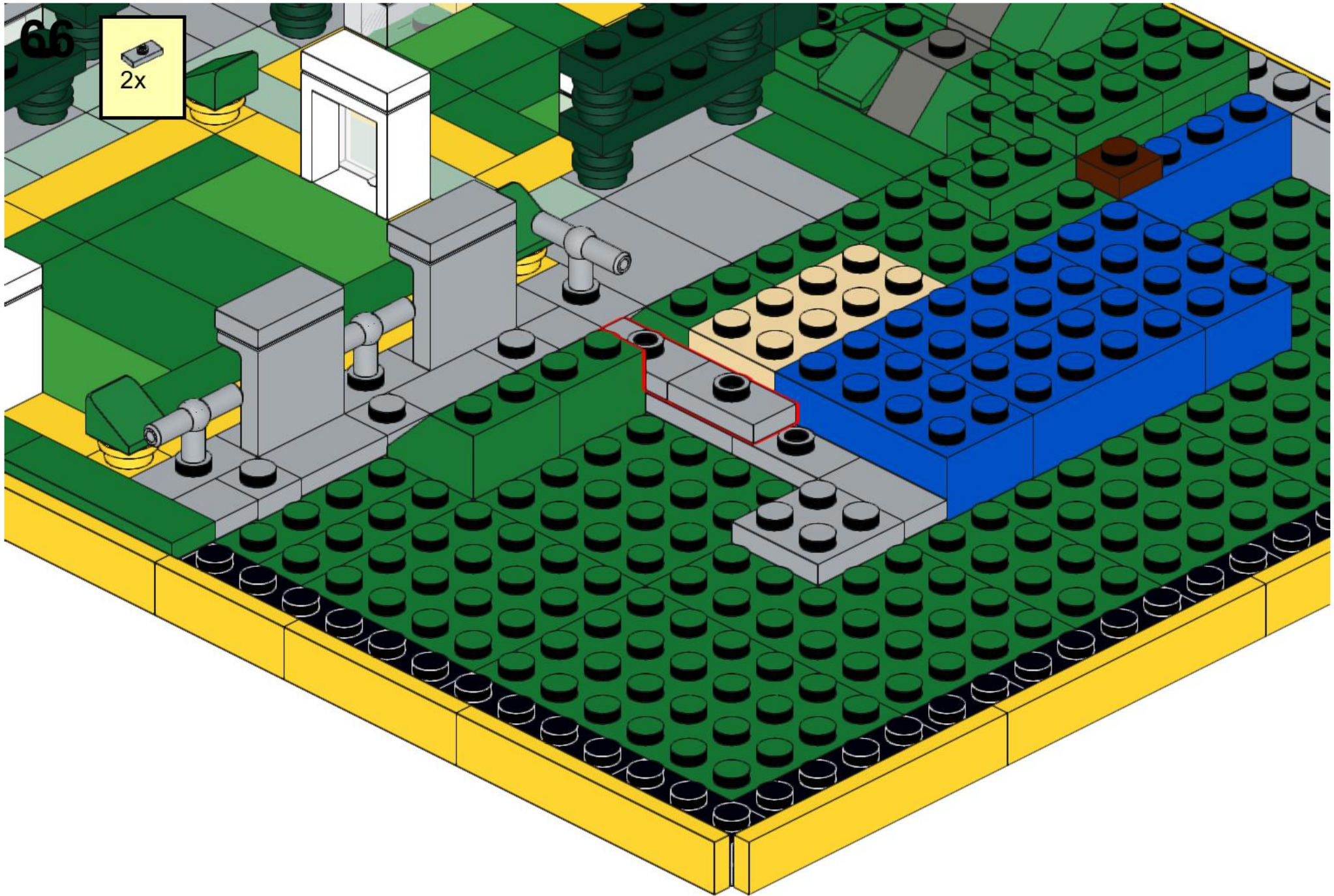

67

1x 1x 1x

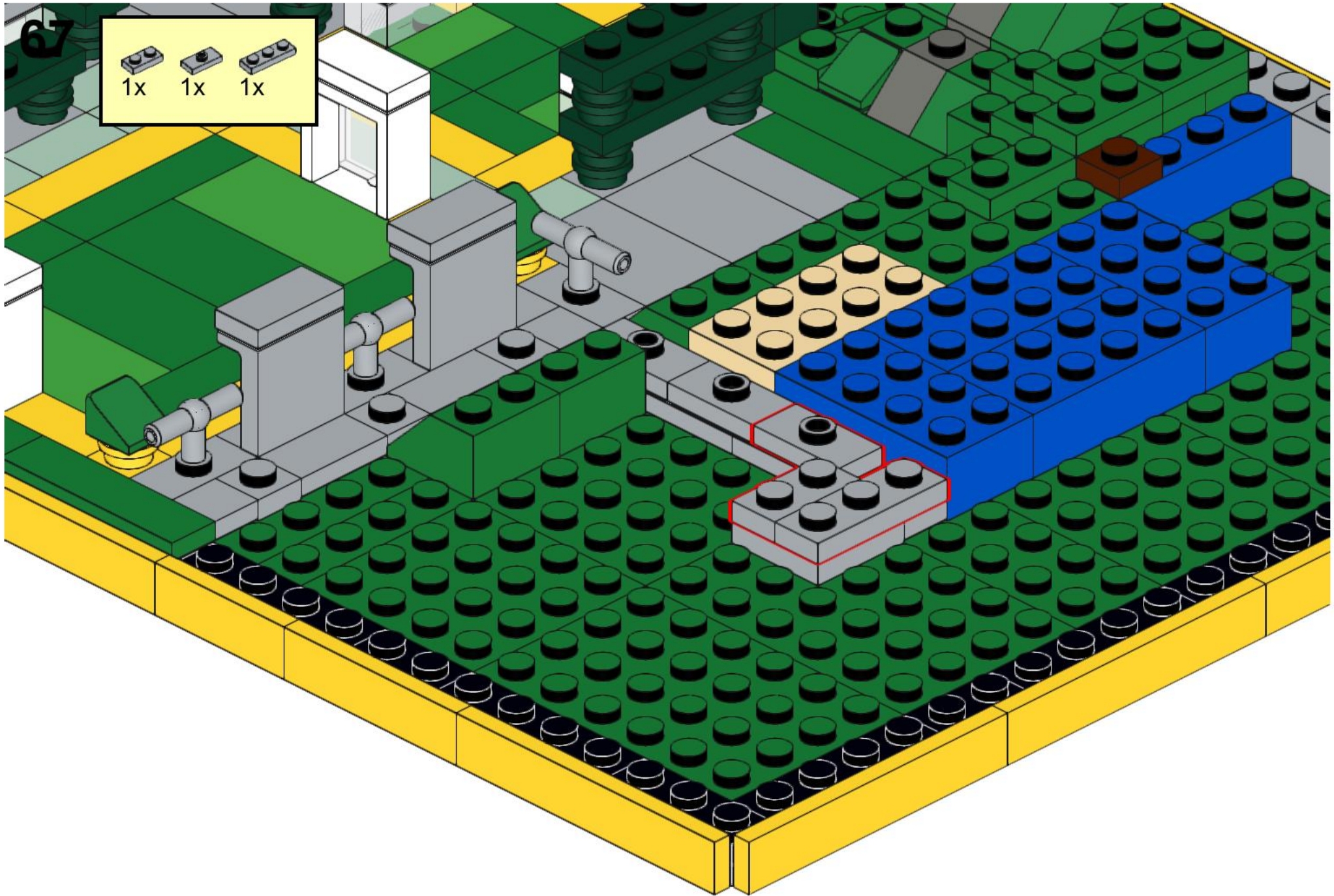
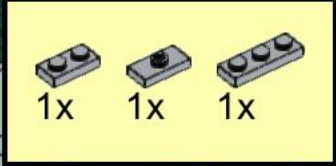

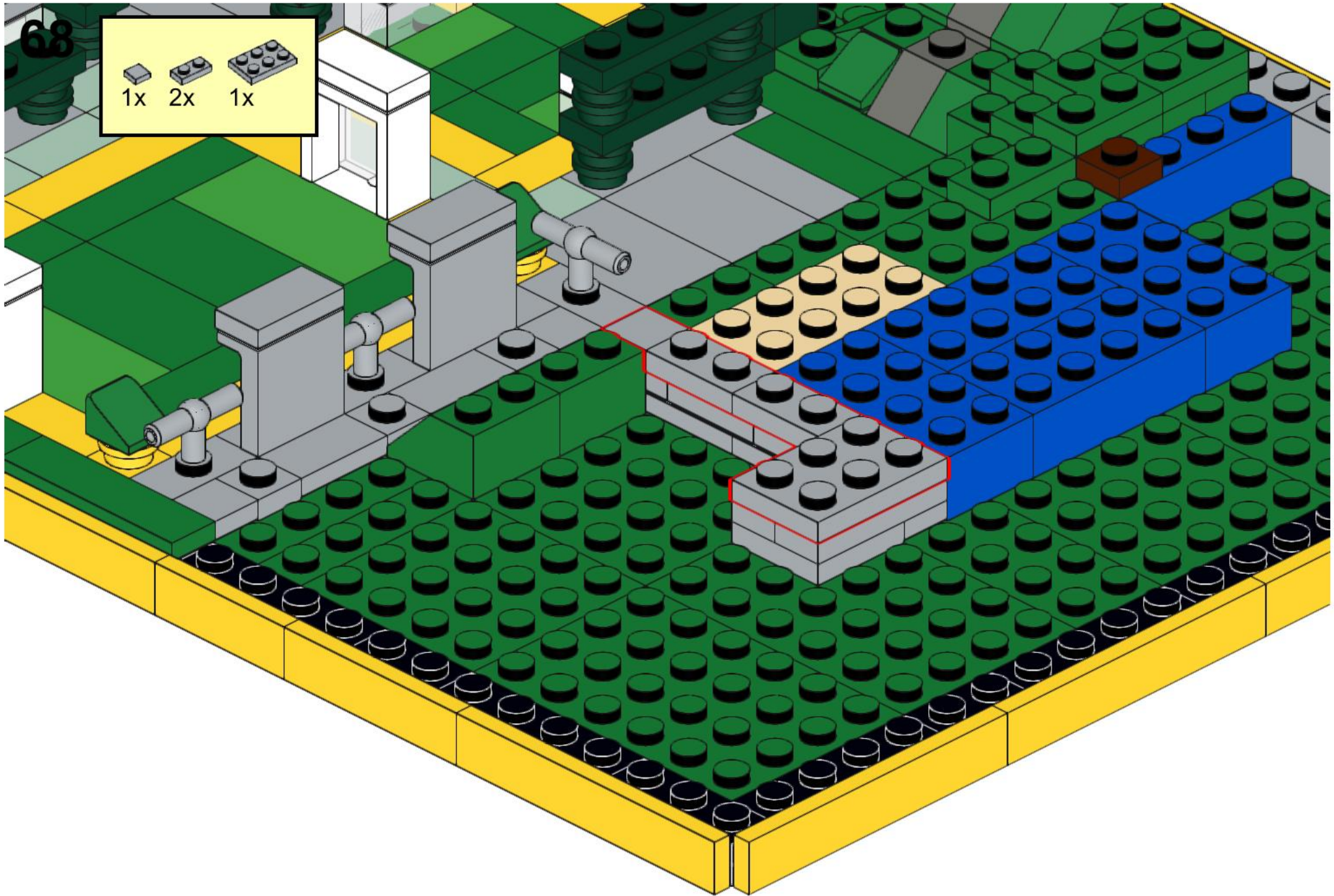

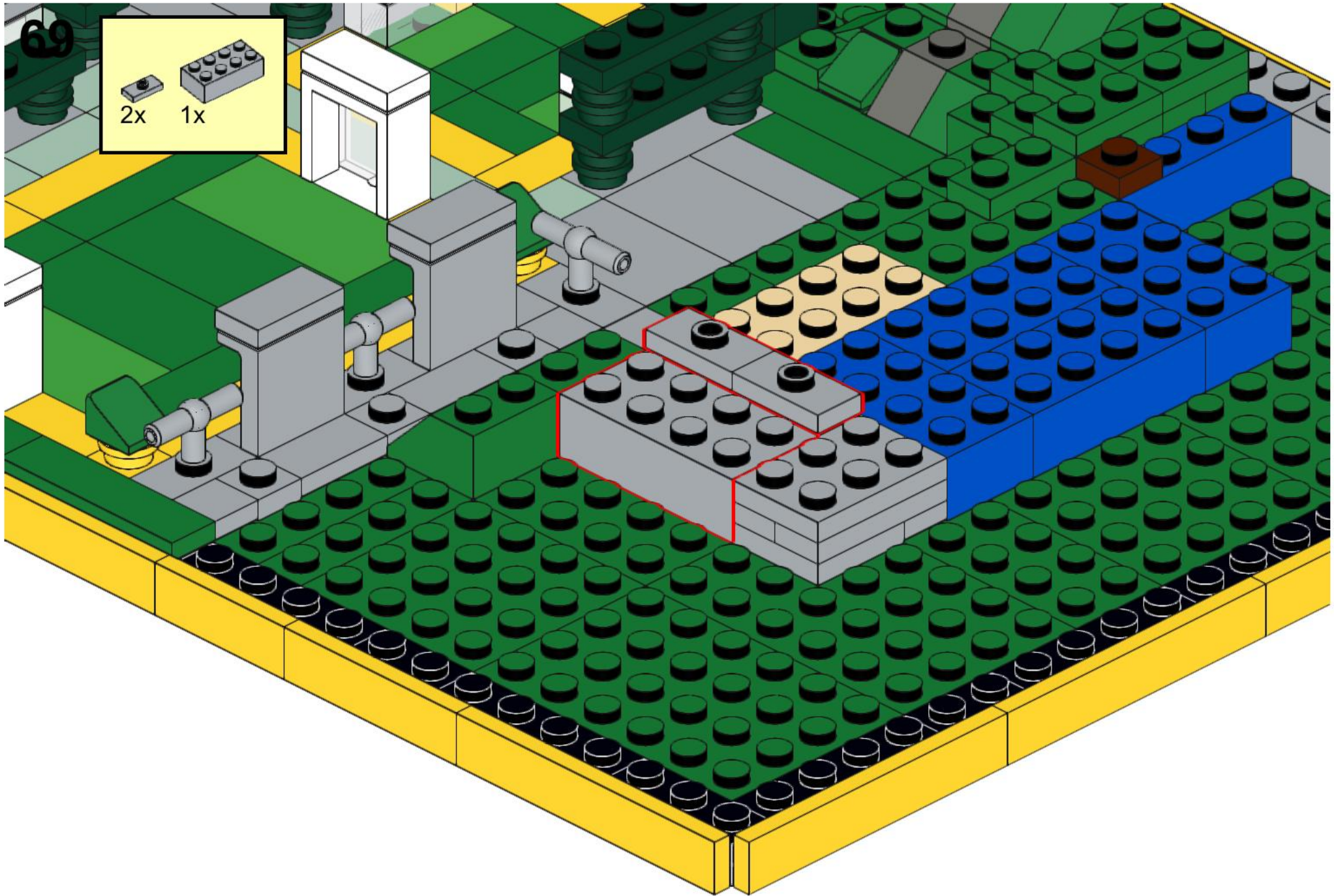

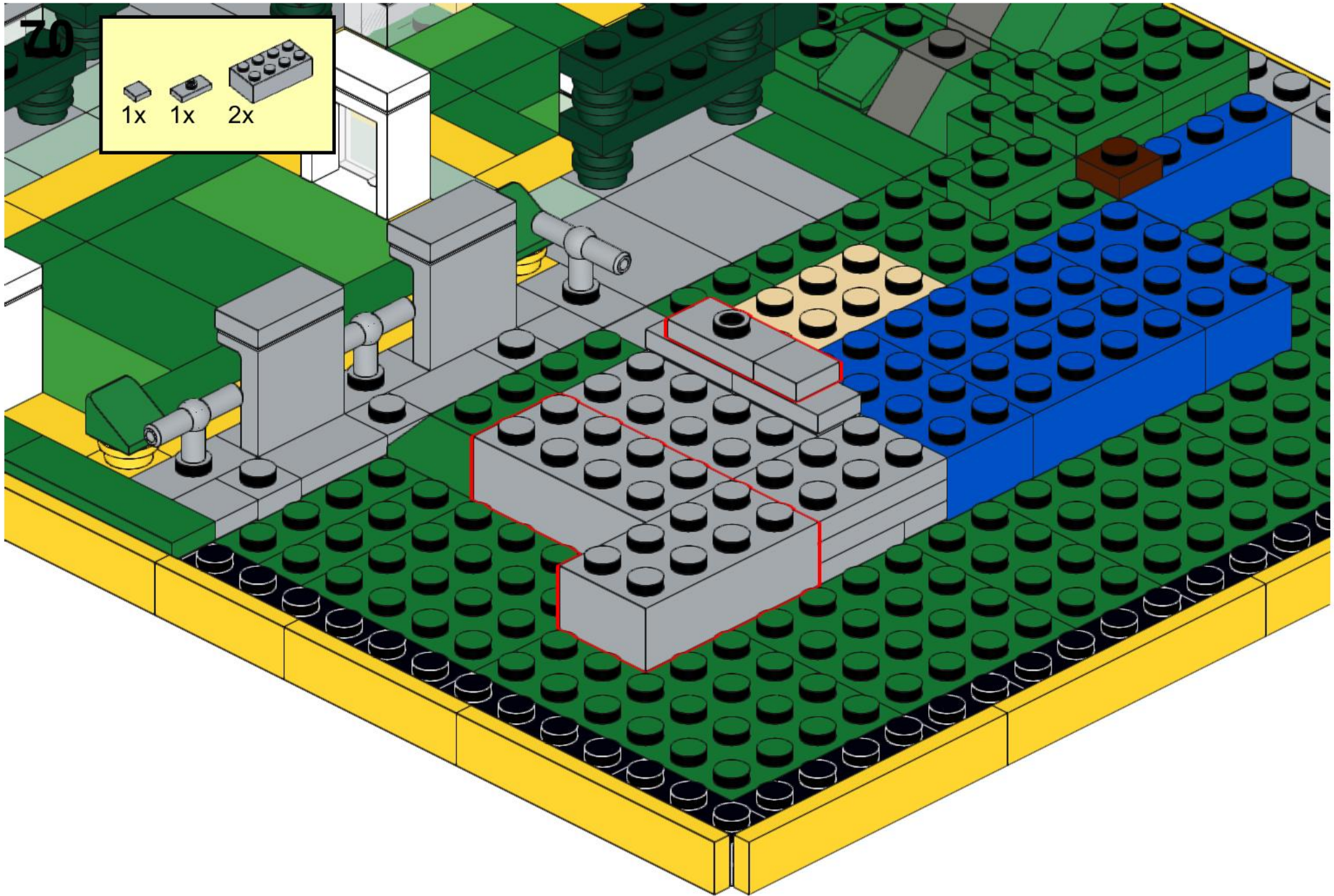

71

3x 2x 1x 1x

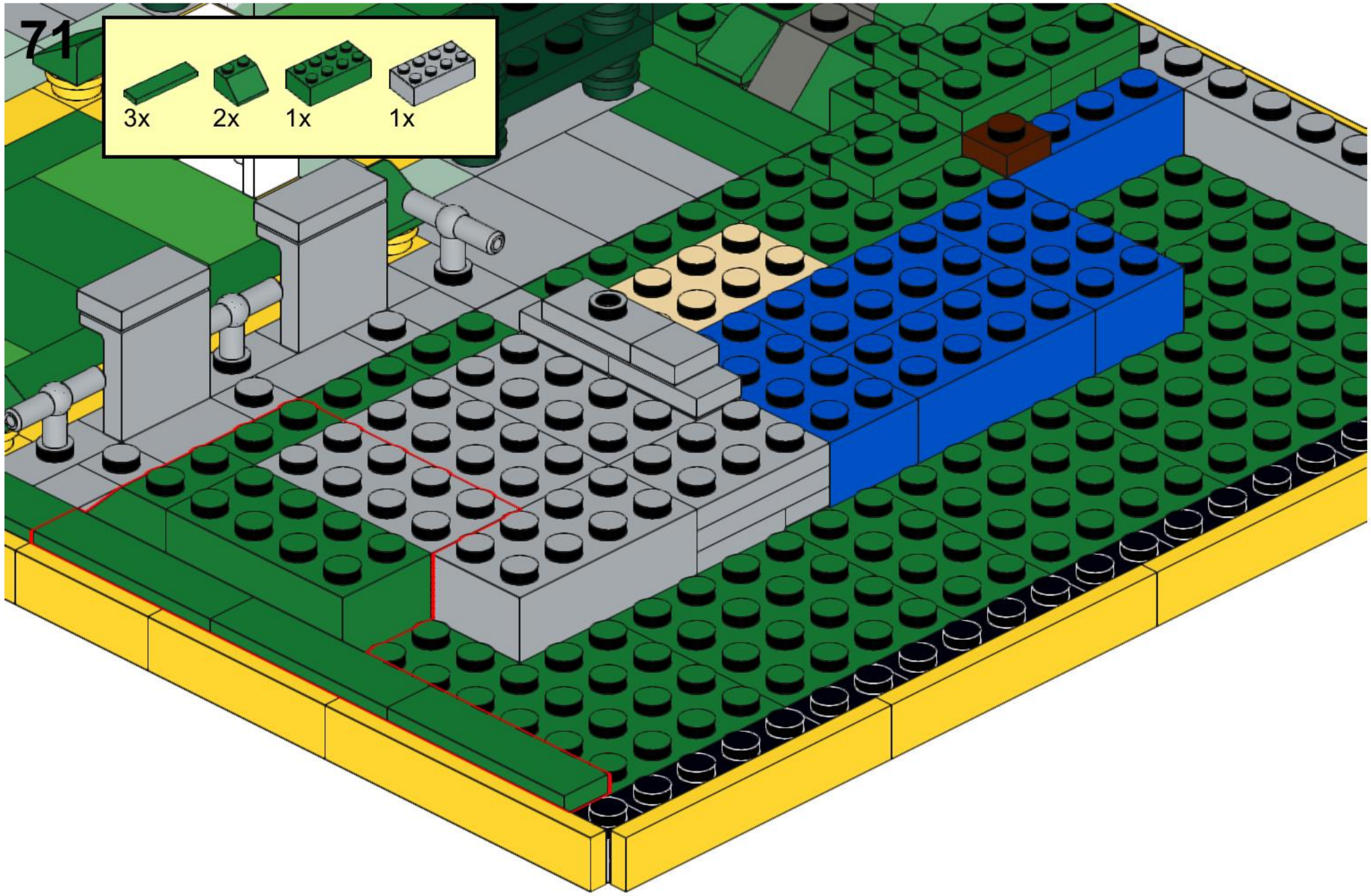
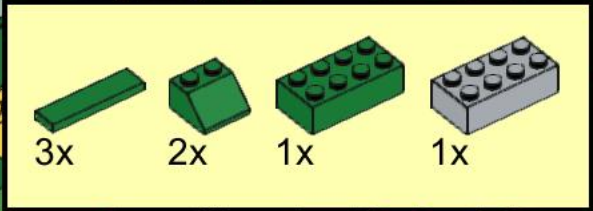

72

2x 1x 2x 1x

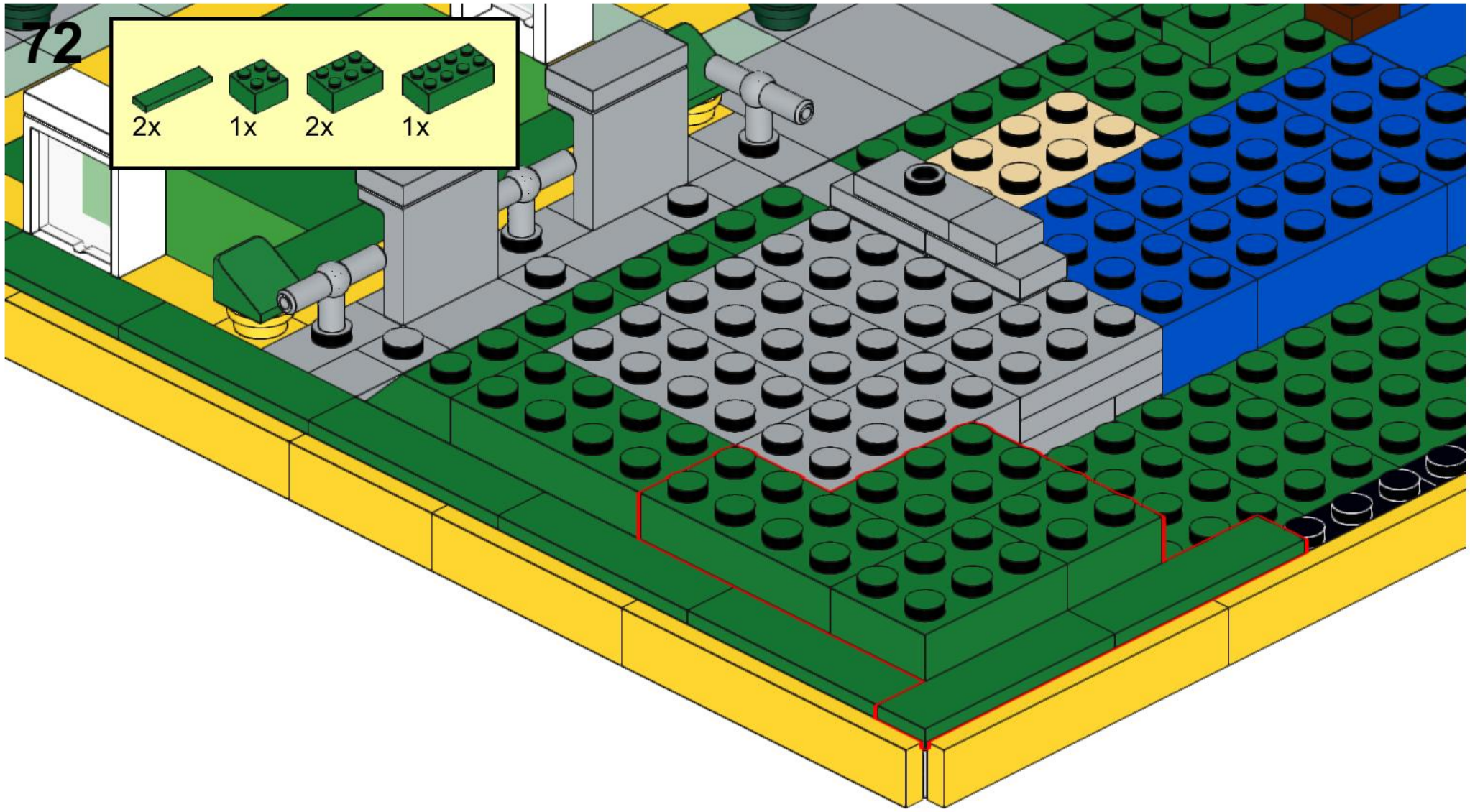
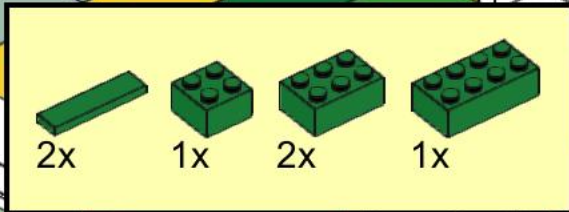

73

1x 1x 2x

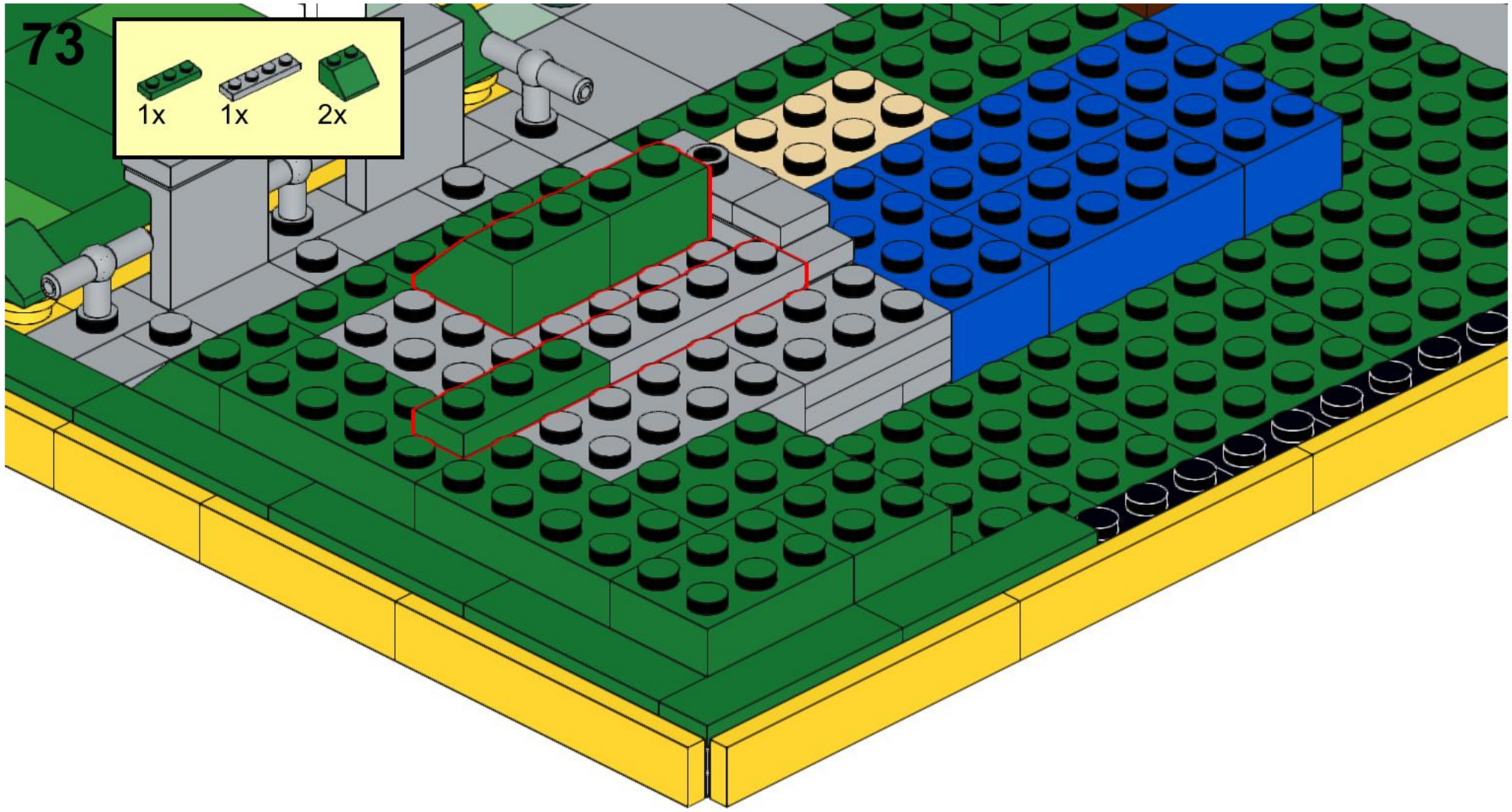
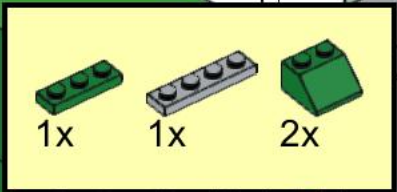

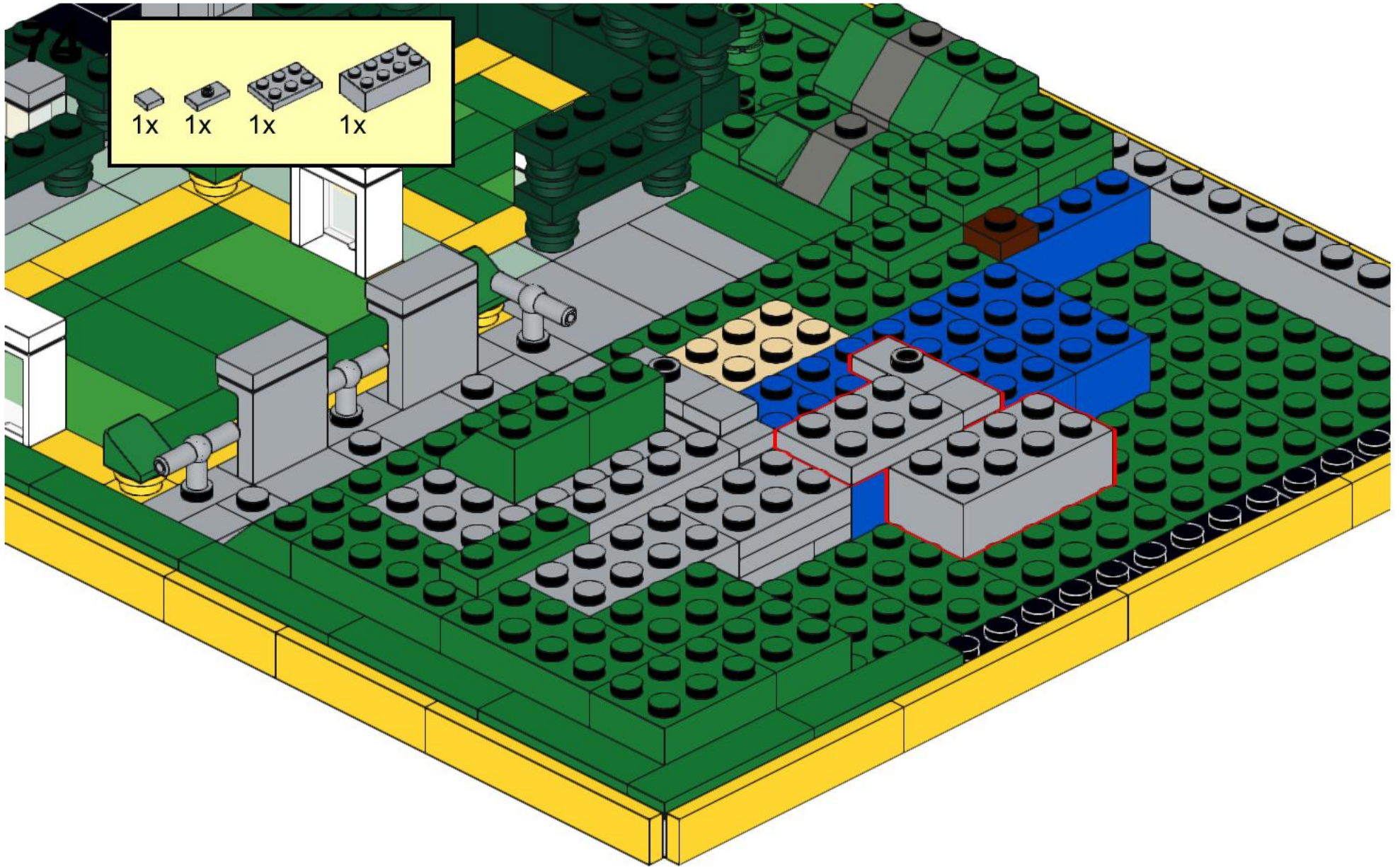

75

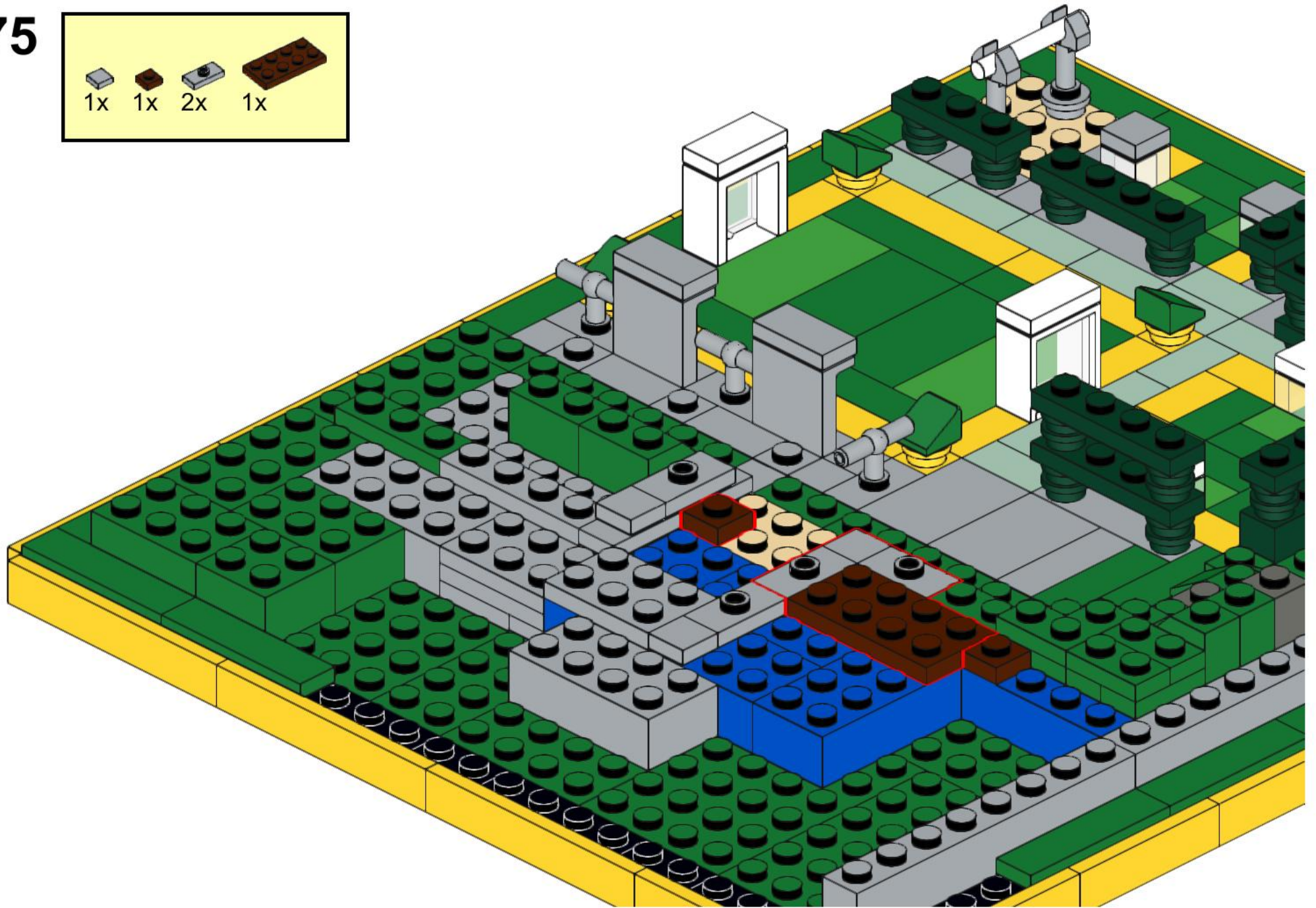
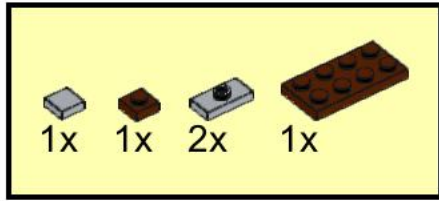

76

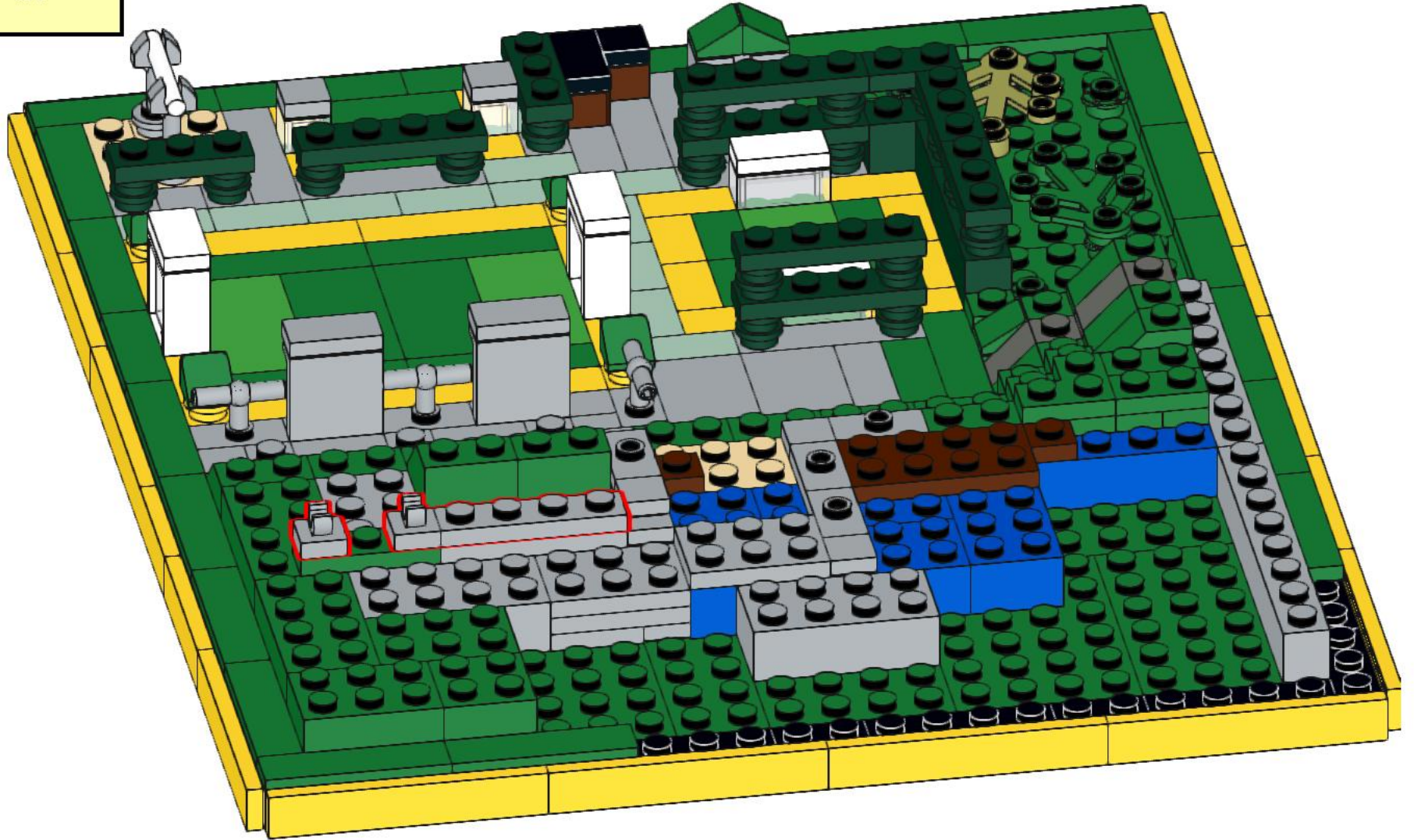
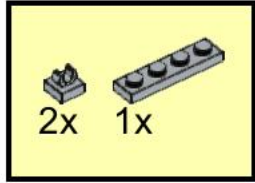



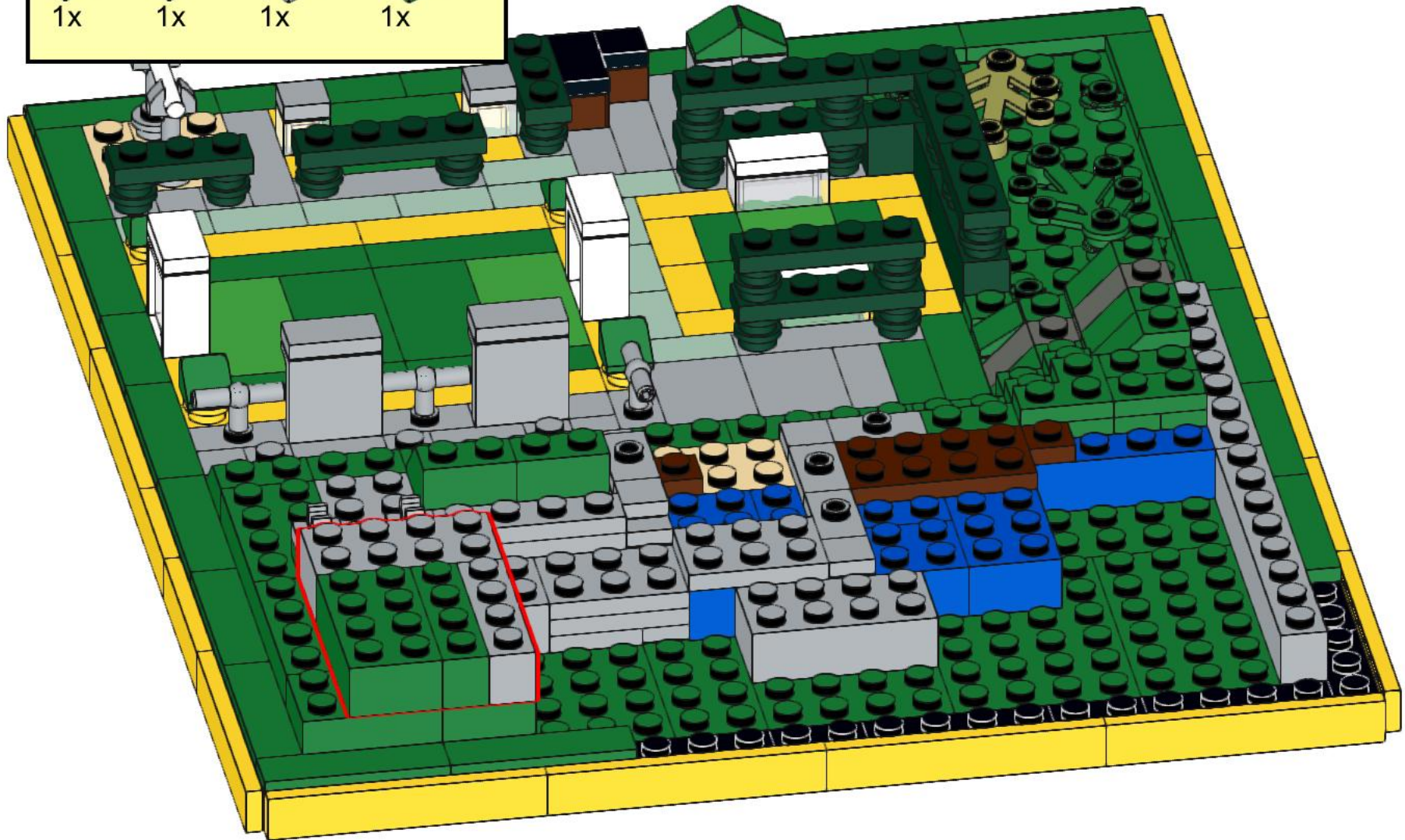
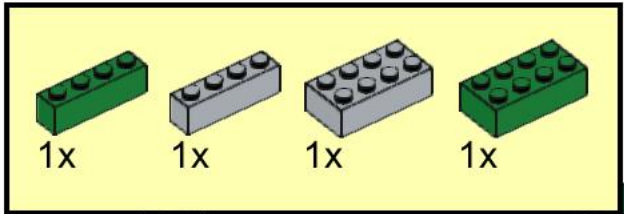

77

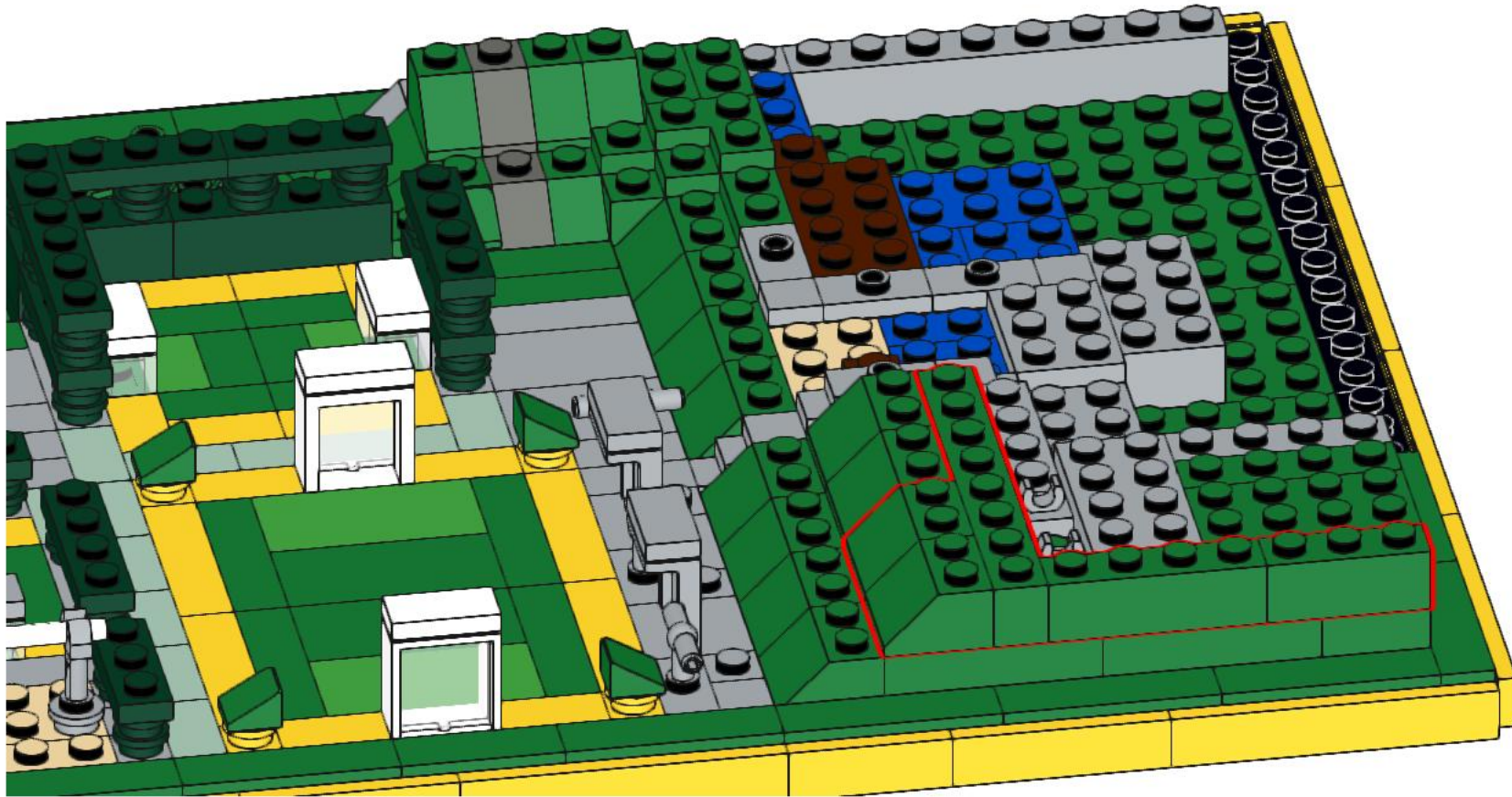
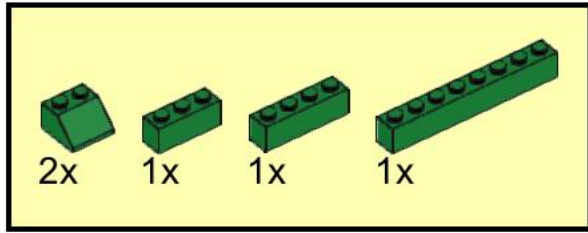

78





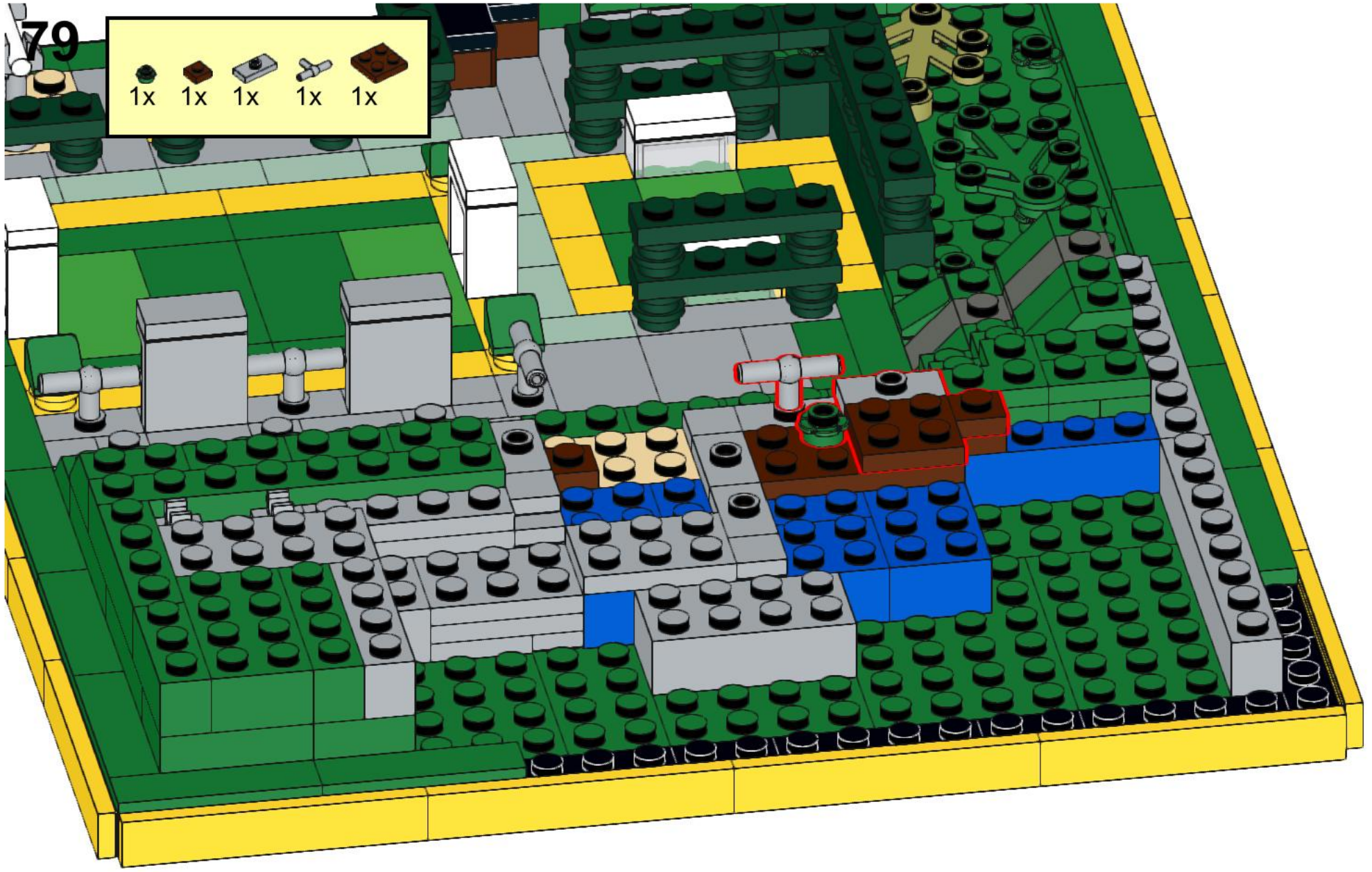

79

				
1x	1x	1x	1x	1x



80

			
1x	3x	1x	2x

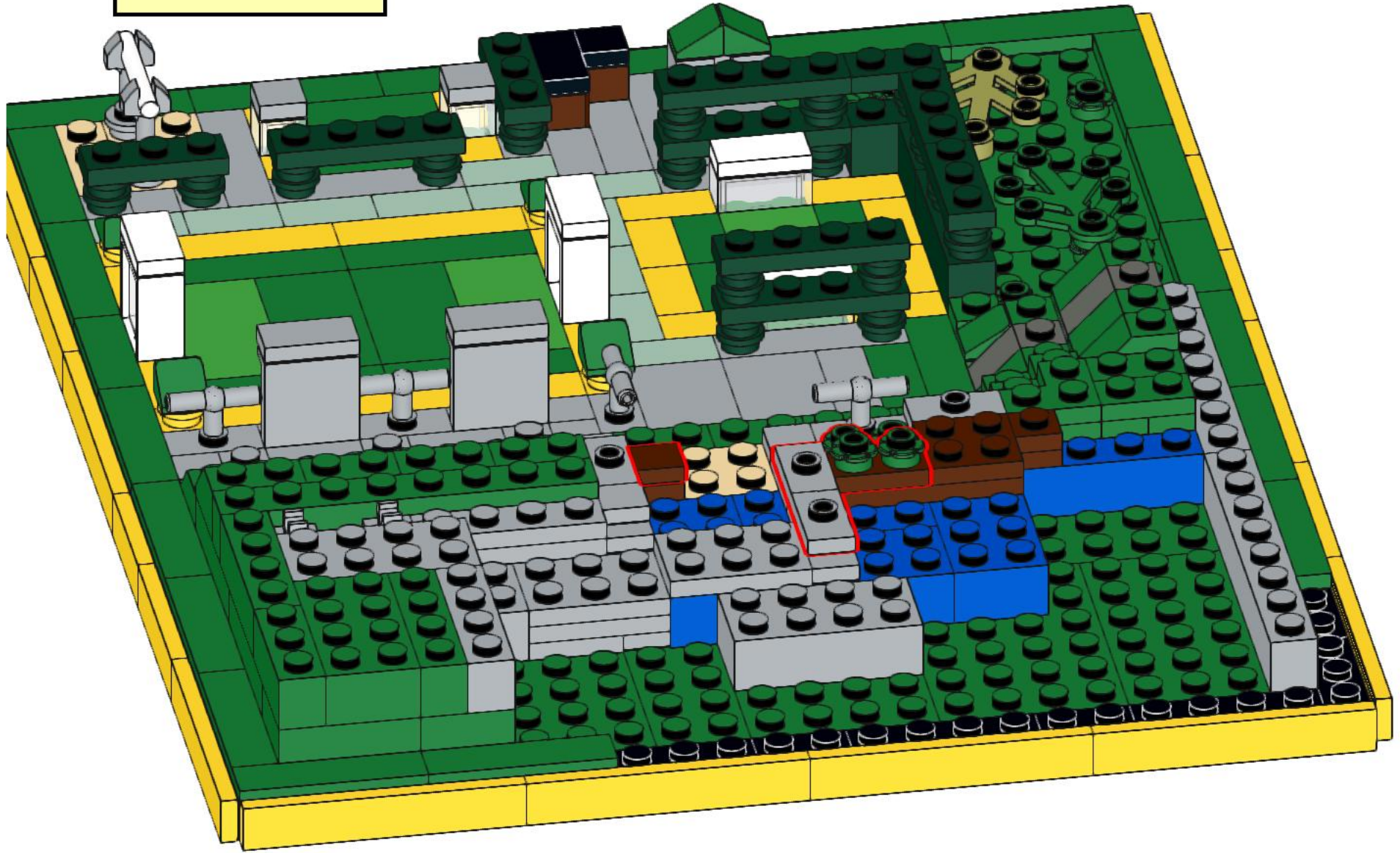

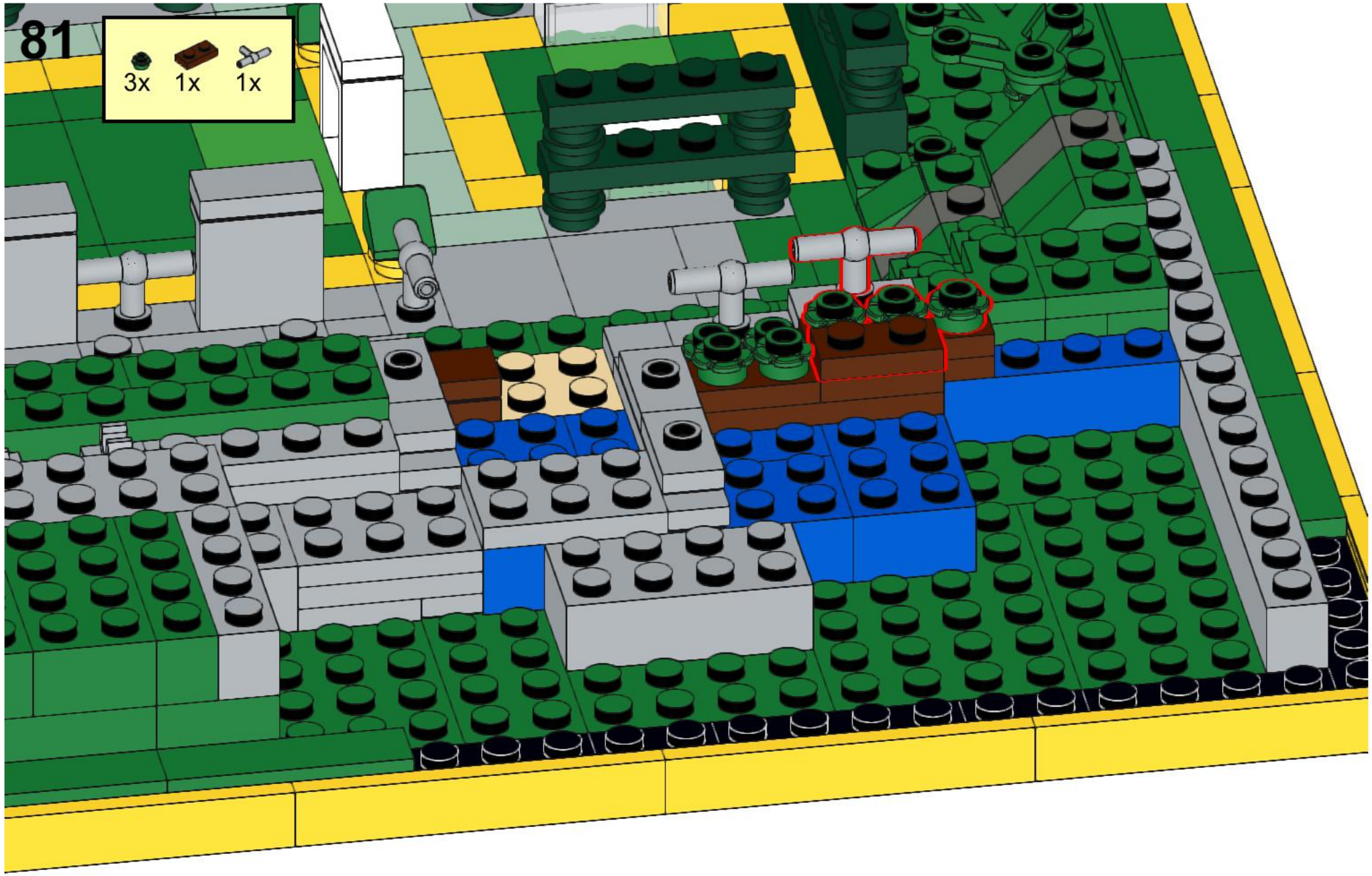

81

		
3x	1x	1x



82

		
3x	1x	1x

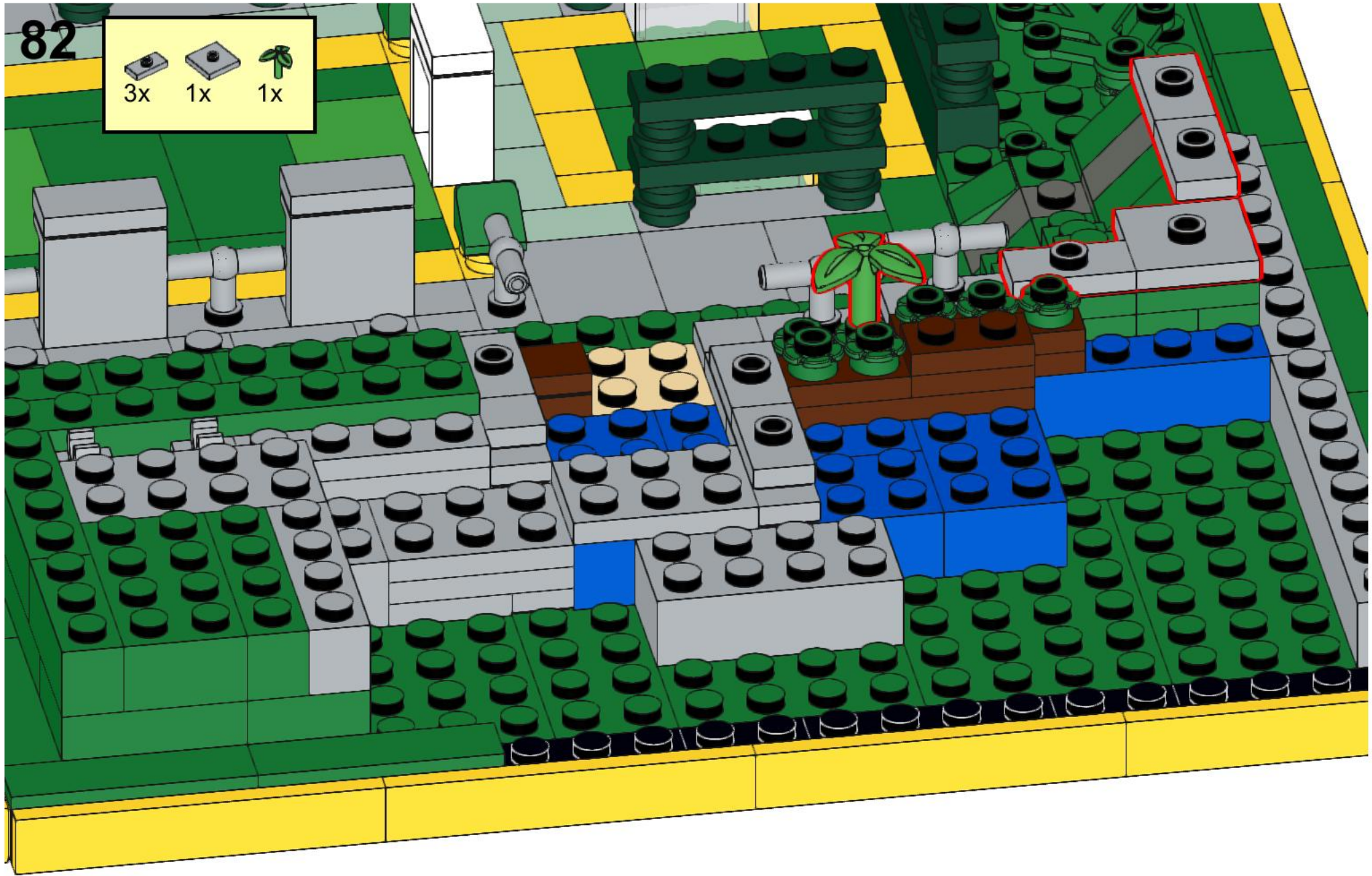

83

			
2x	1x	1x	2x

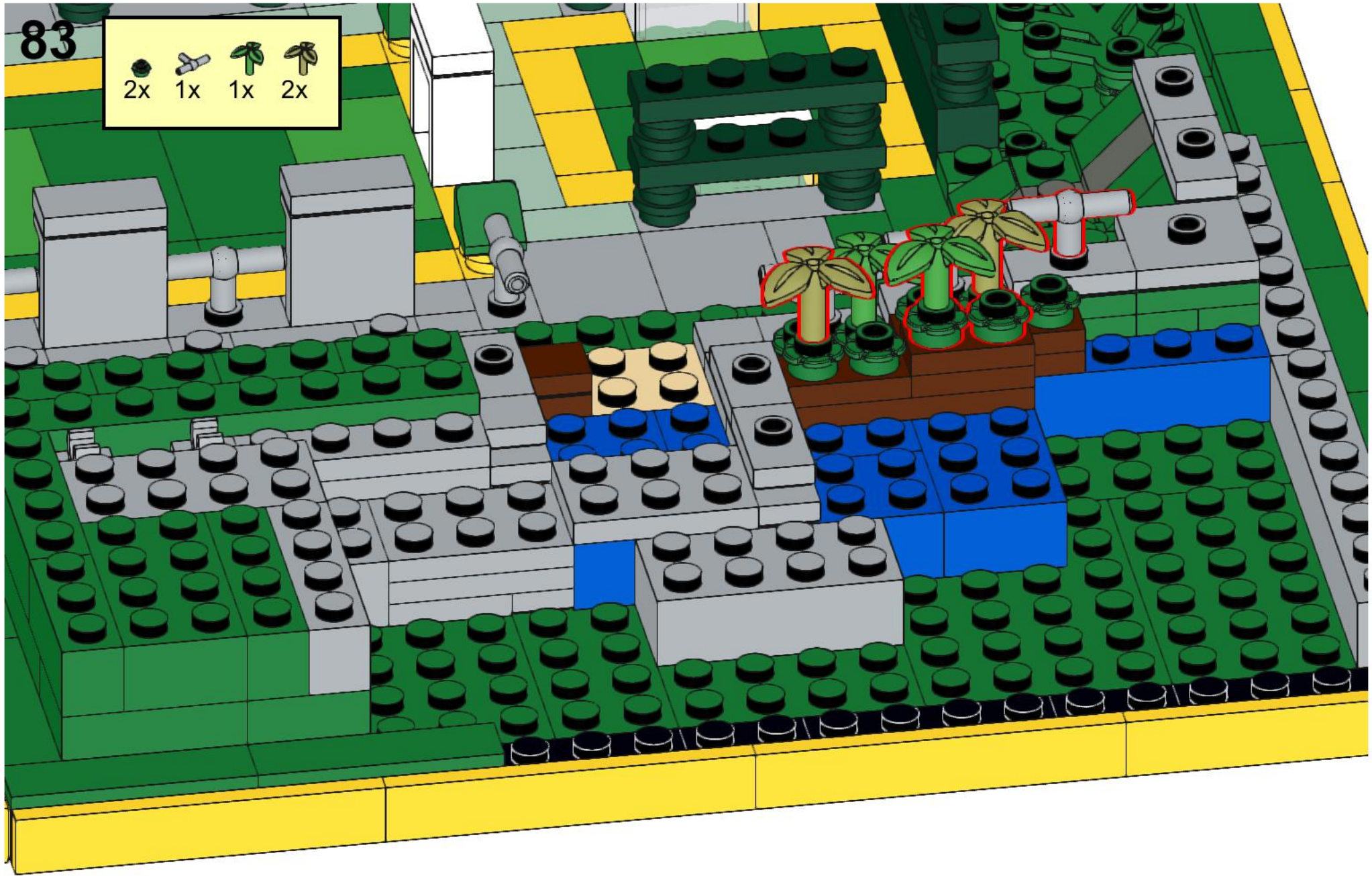

84

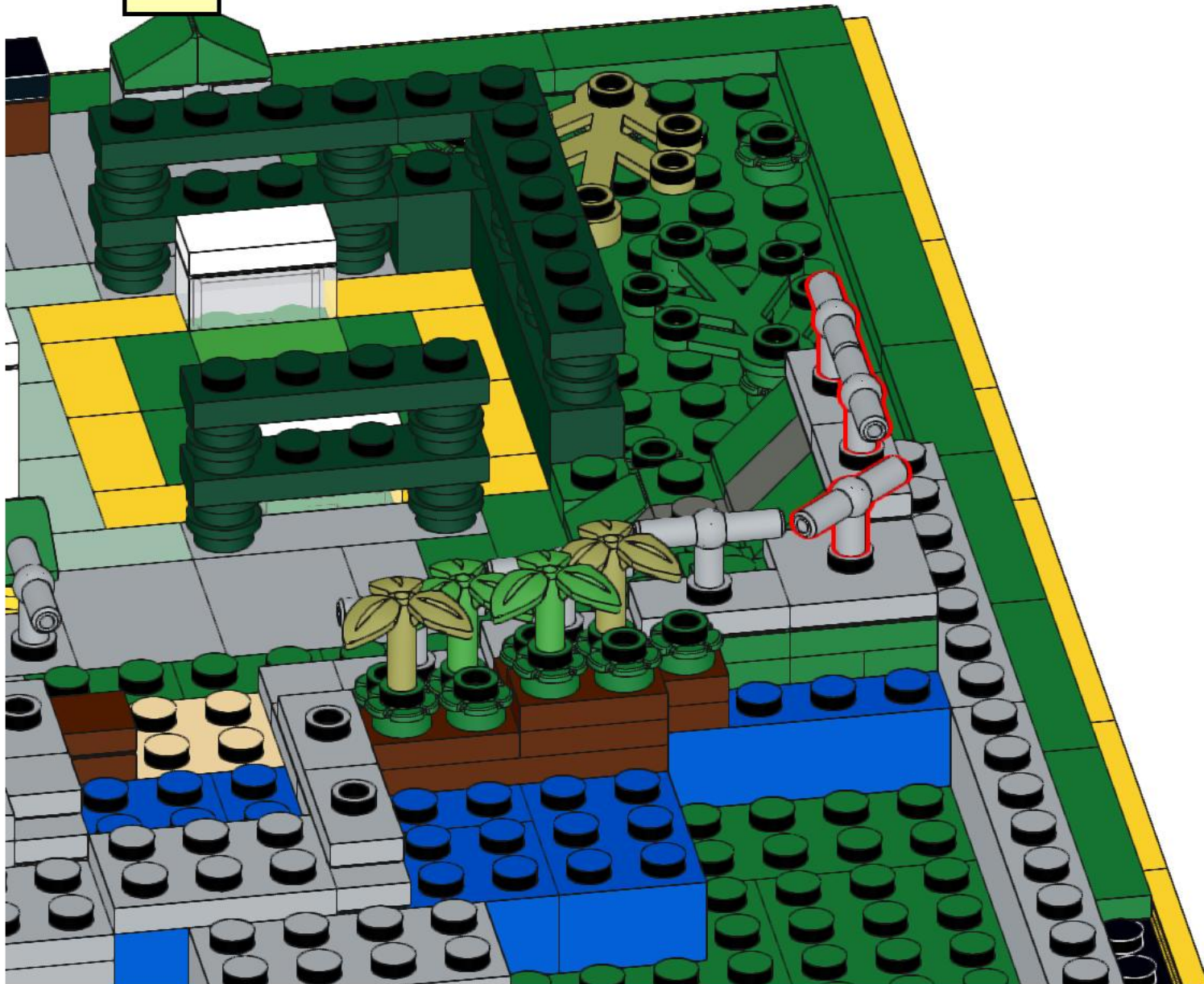
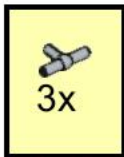

85

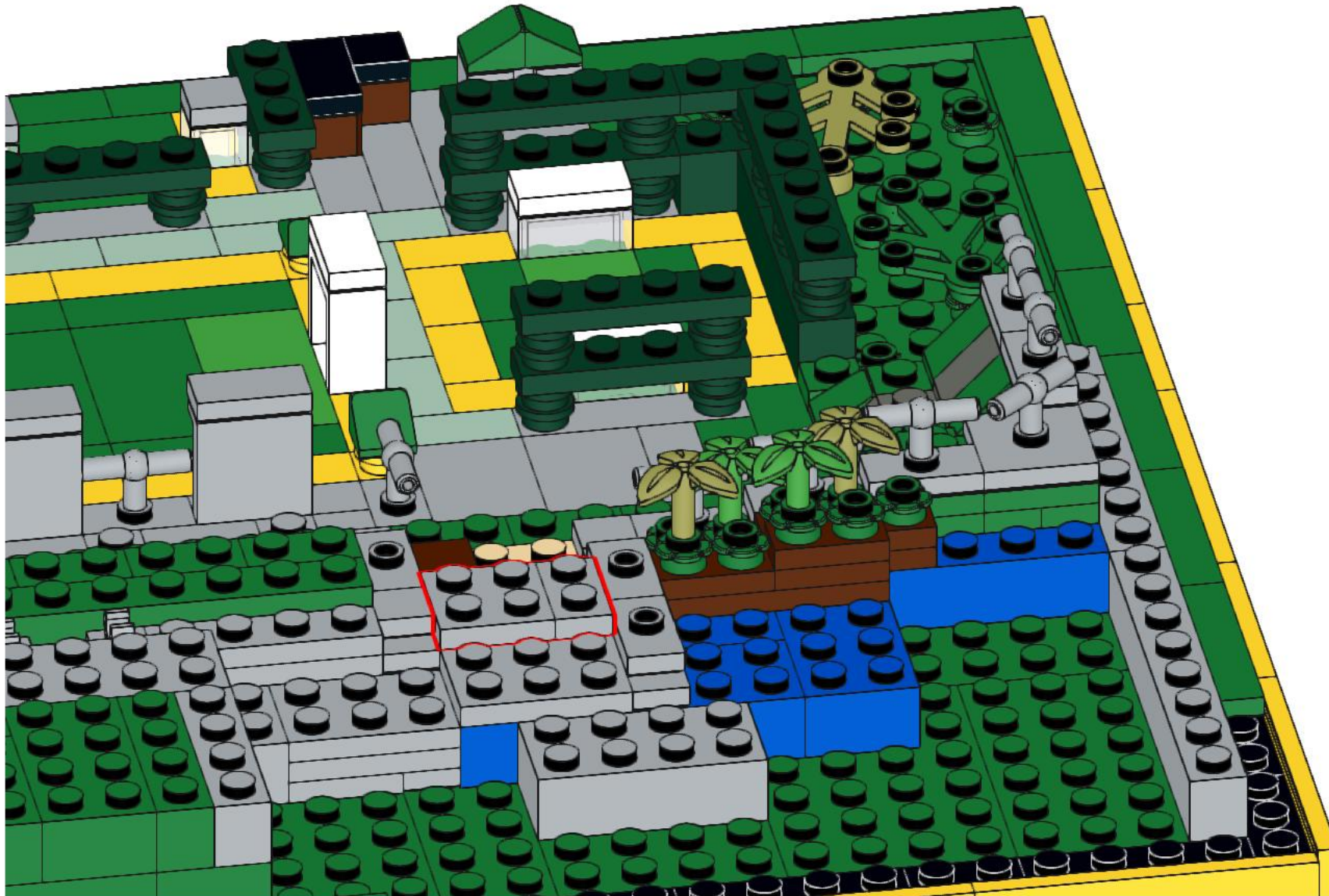
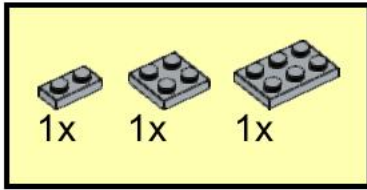

86

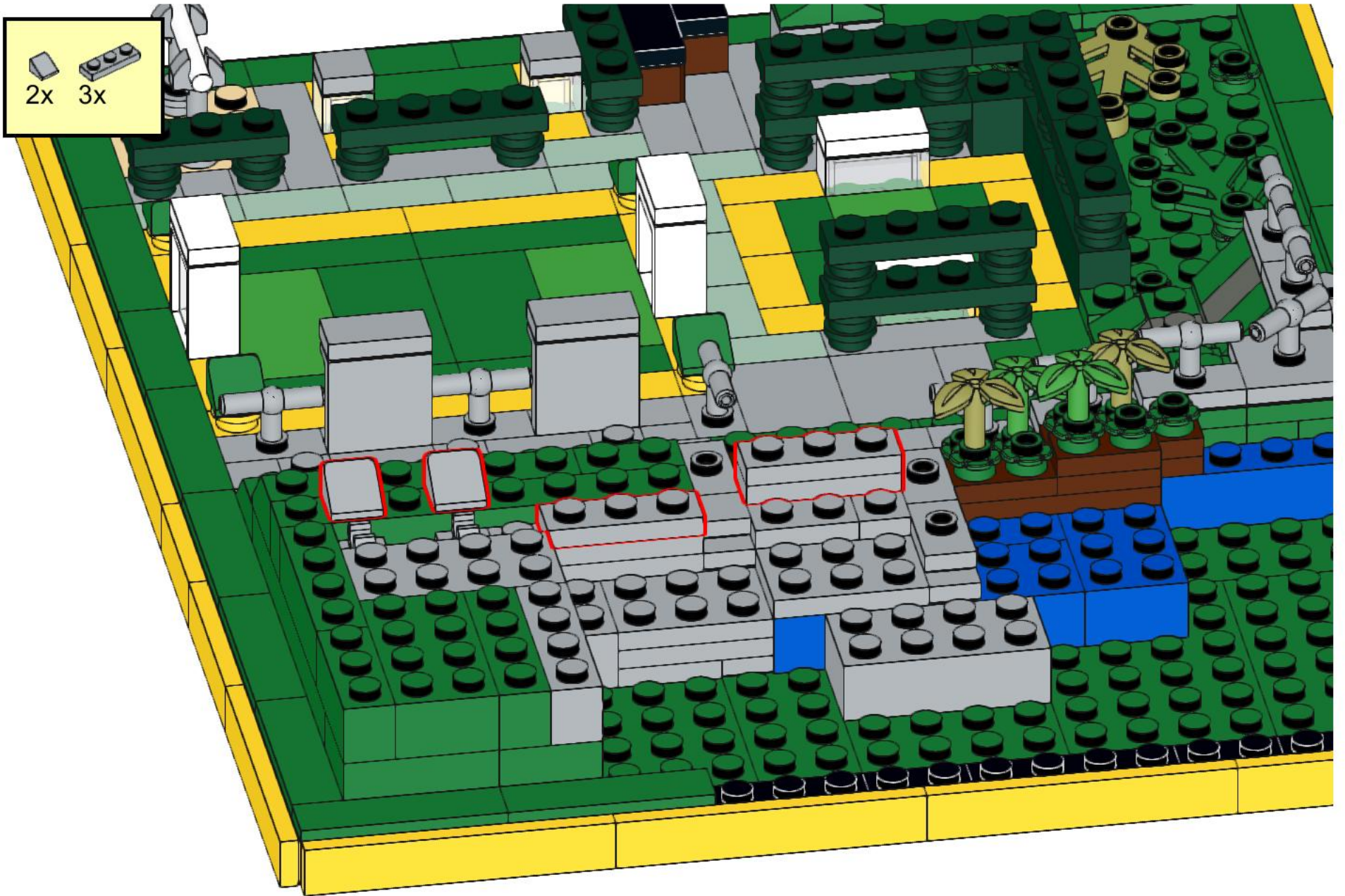
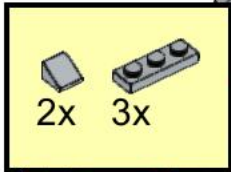

87

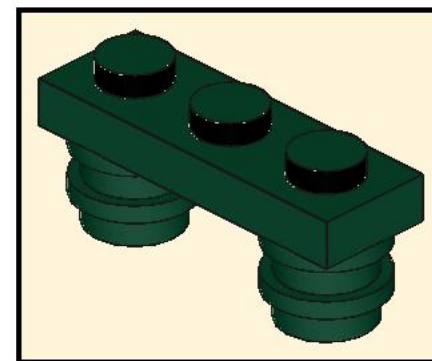
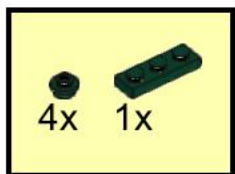

88

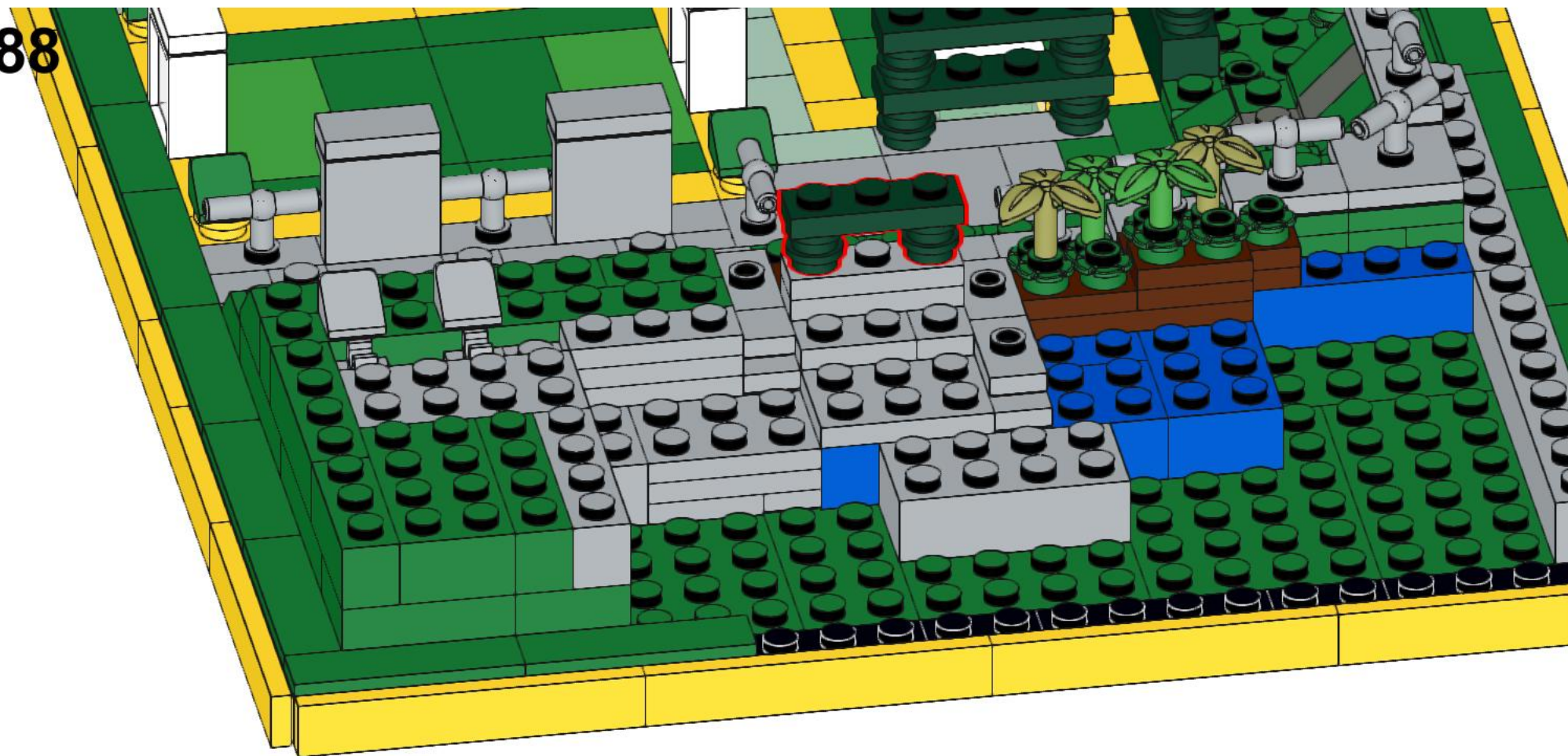

89

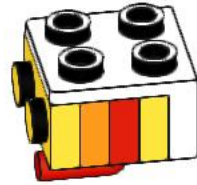
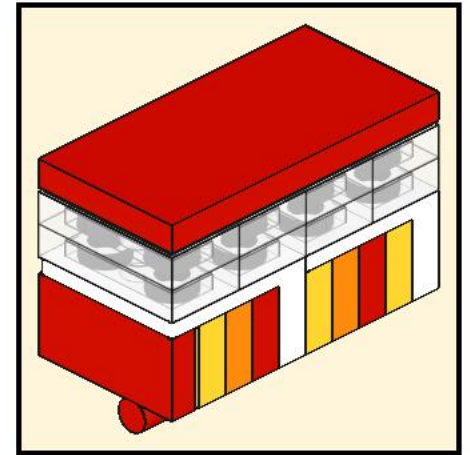
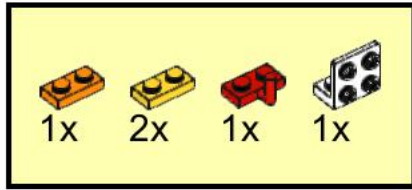

90

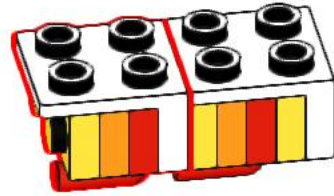
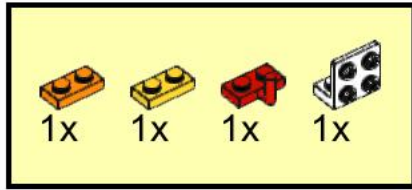

91

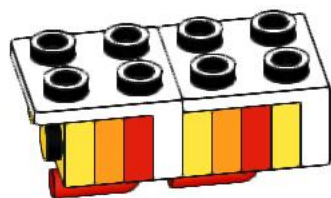

92

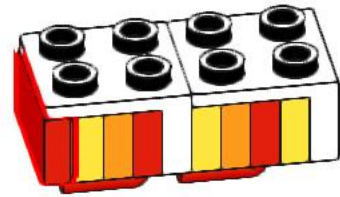
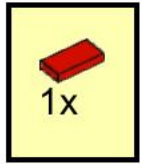

93

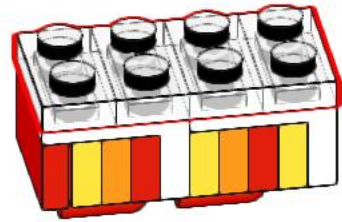
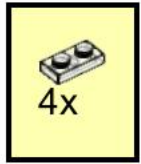

94

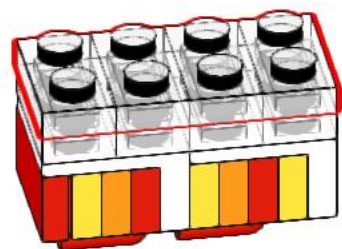
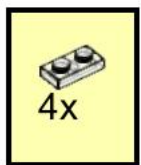

95

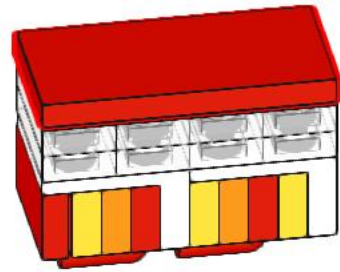
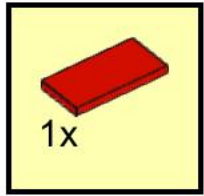

96

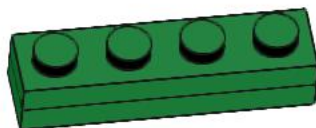
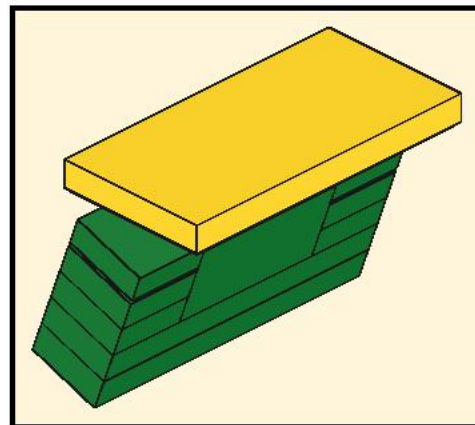
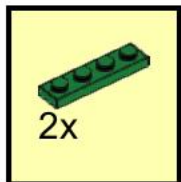

97

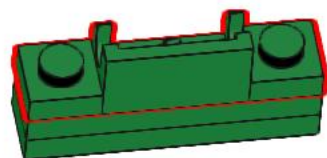
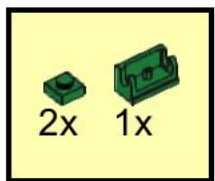

98

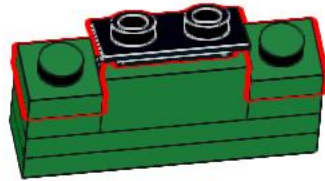
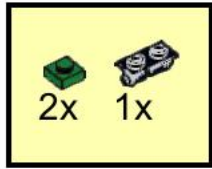

99

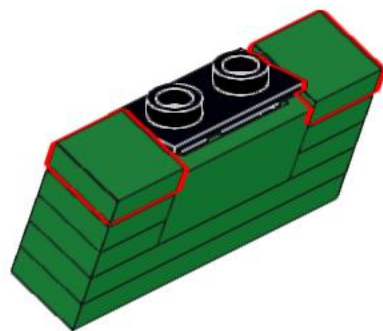
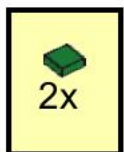

100

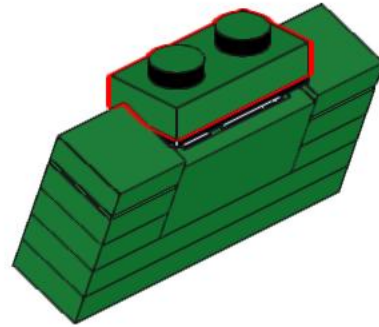
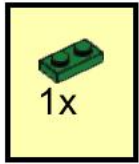

101

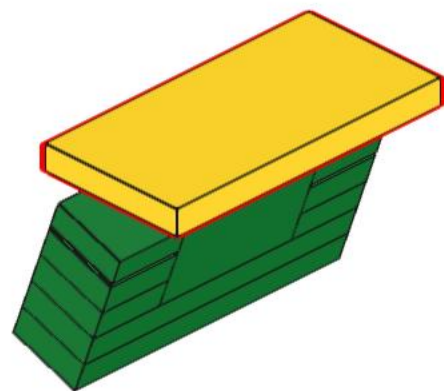
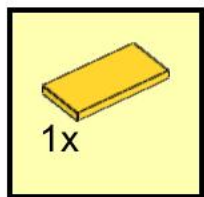

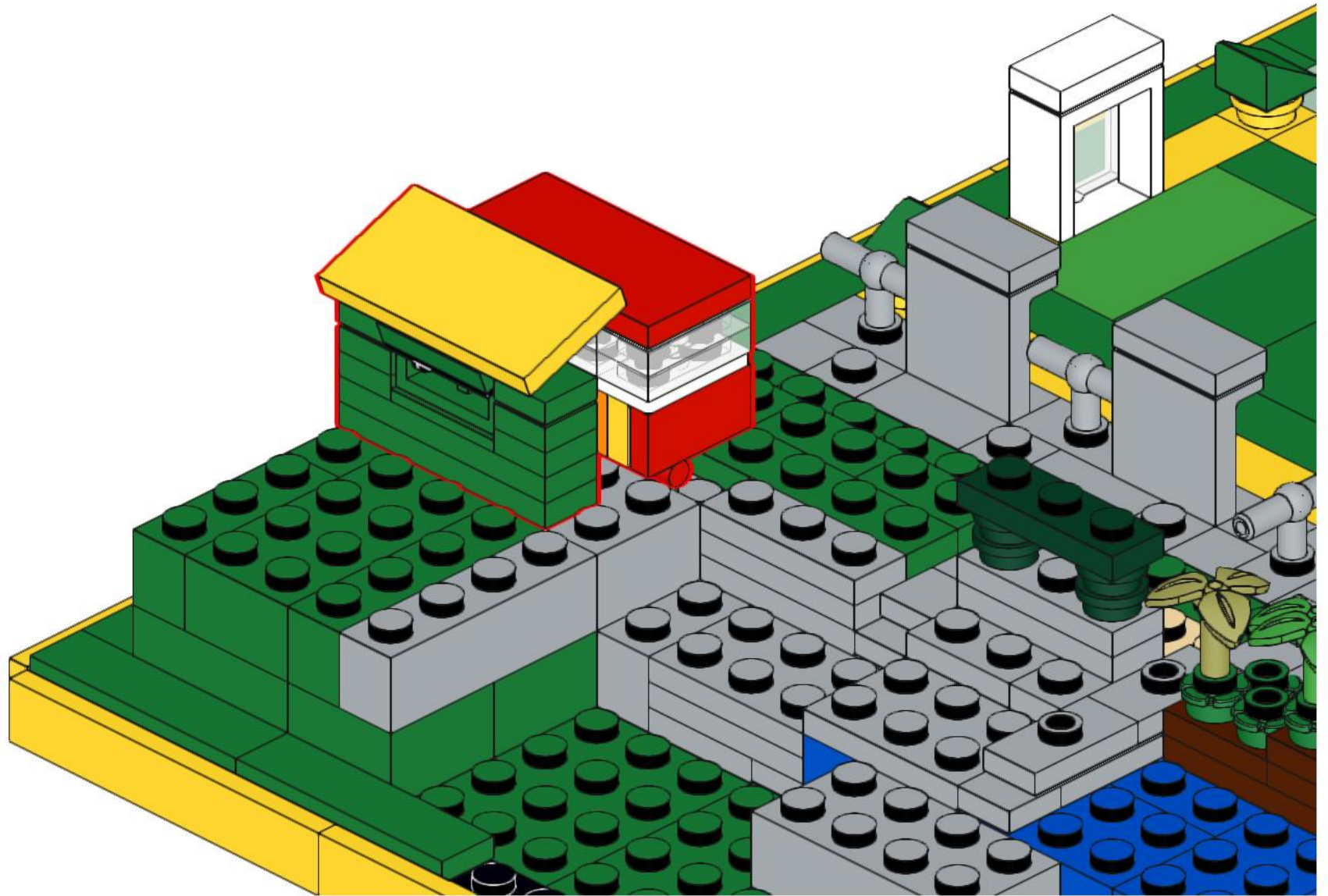

103

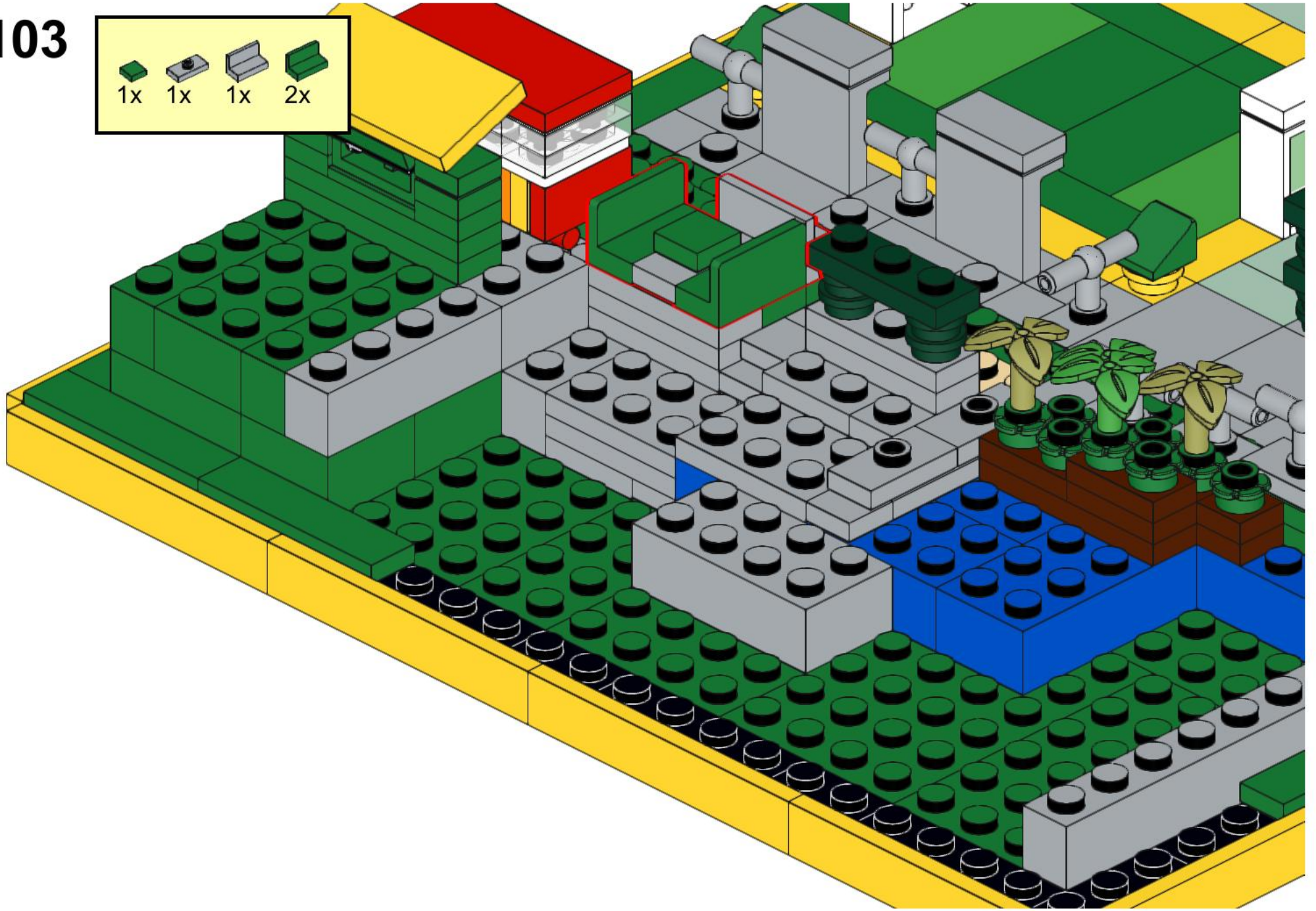
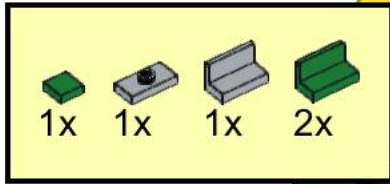

104

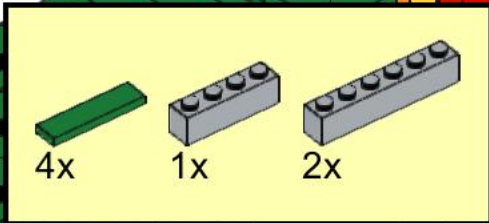

4x
1x
2x

This inset box shows the parts list for step 104. It contains three items: a green 1x3 Technic brick (labeled 4x), a grey 1x3 Technic brick with a hole (labeled 1x), and a grey 1x5 Technic brick with a hole (labeled 2x).

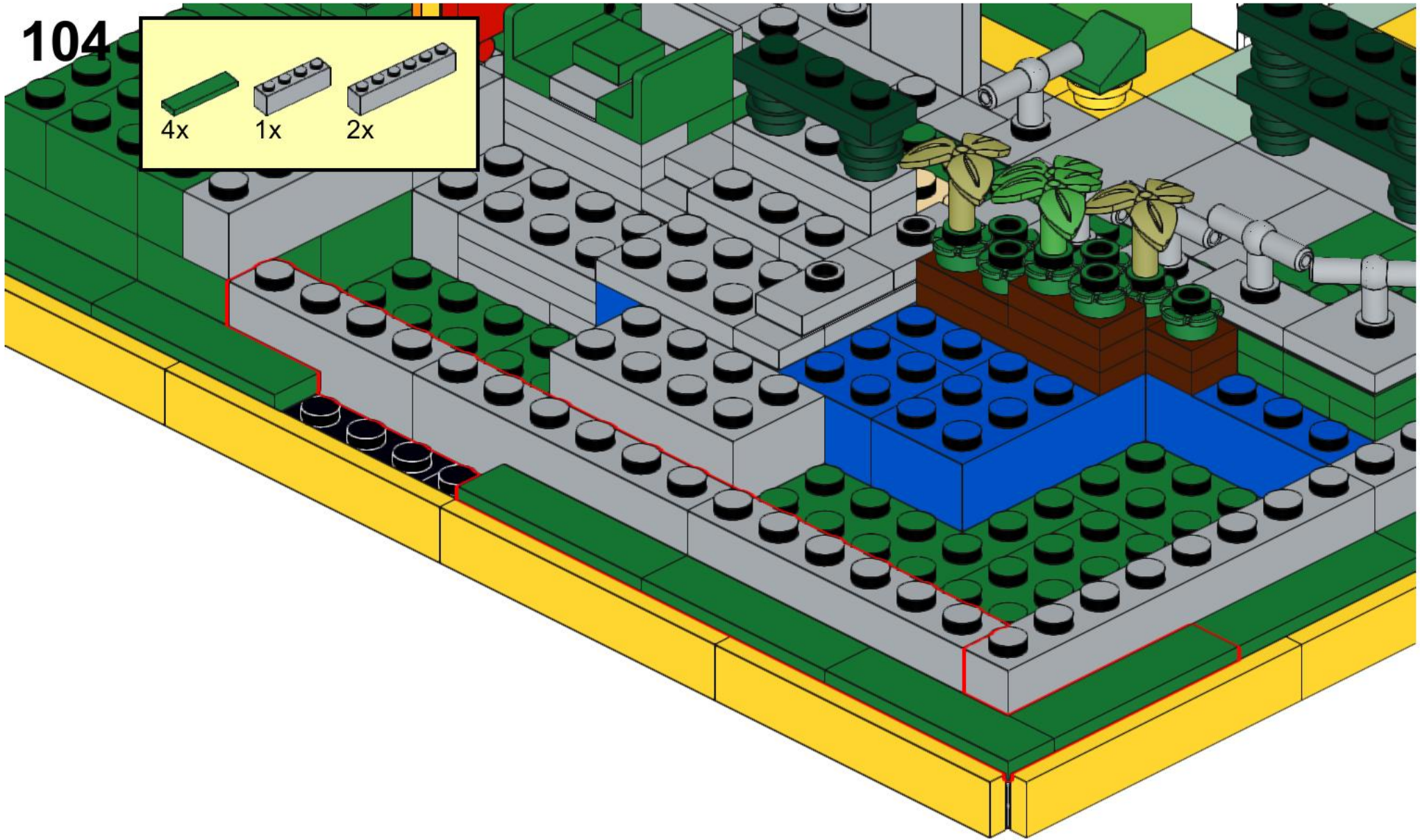

105

2x 1x 1x 1x 1x 2x 1x

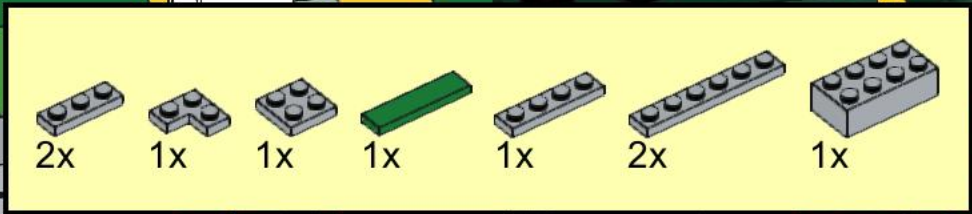

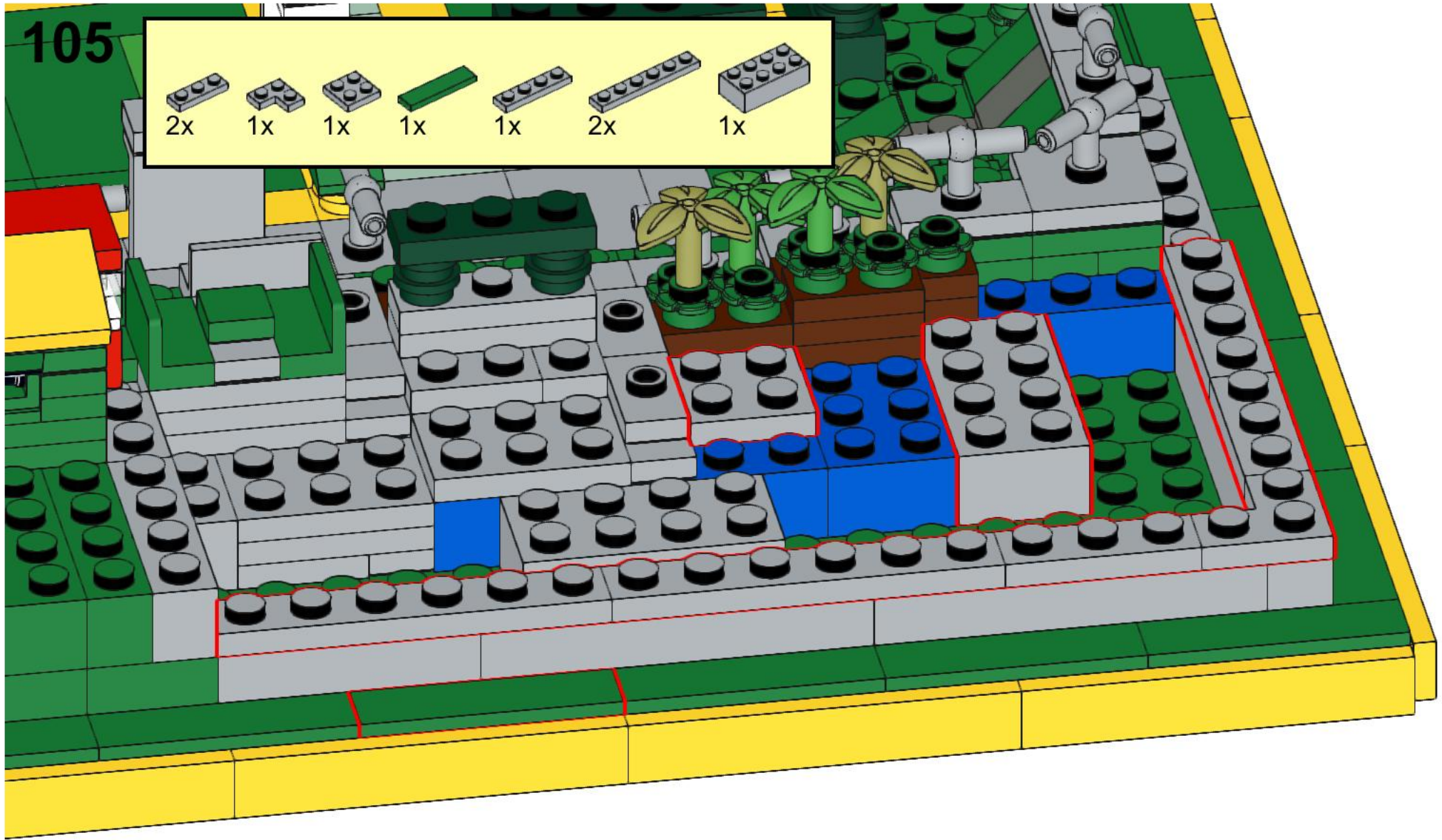

A yellow rectangular box containing a list of LEGO parts with their quantities. From left to right: a grey 1x3 Technic brick with 3 holes (2x), a grey 1x2 Technic brick with 2 holes (1x), a grey 1x3 Technic brick with 3 holes (1x), a green 1x3 Technic Technonote (1x), a grey 1x3 Technic brick with 3 holes (1x), a grey 1x6 Technic brick with 6 holes (2x), and a grey 1x4 Technic brick with 4 holes (1x).

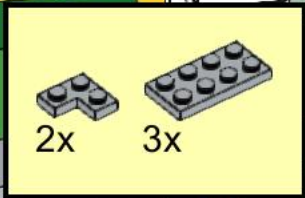

106



2x  3x 

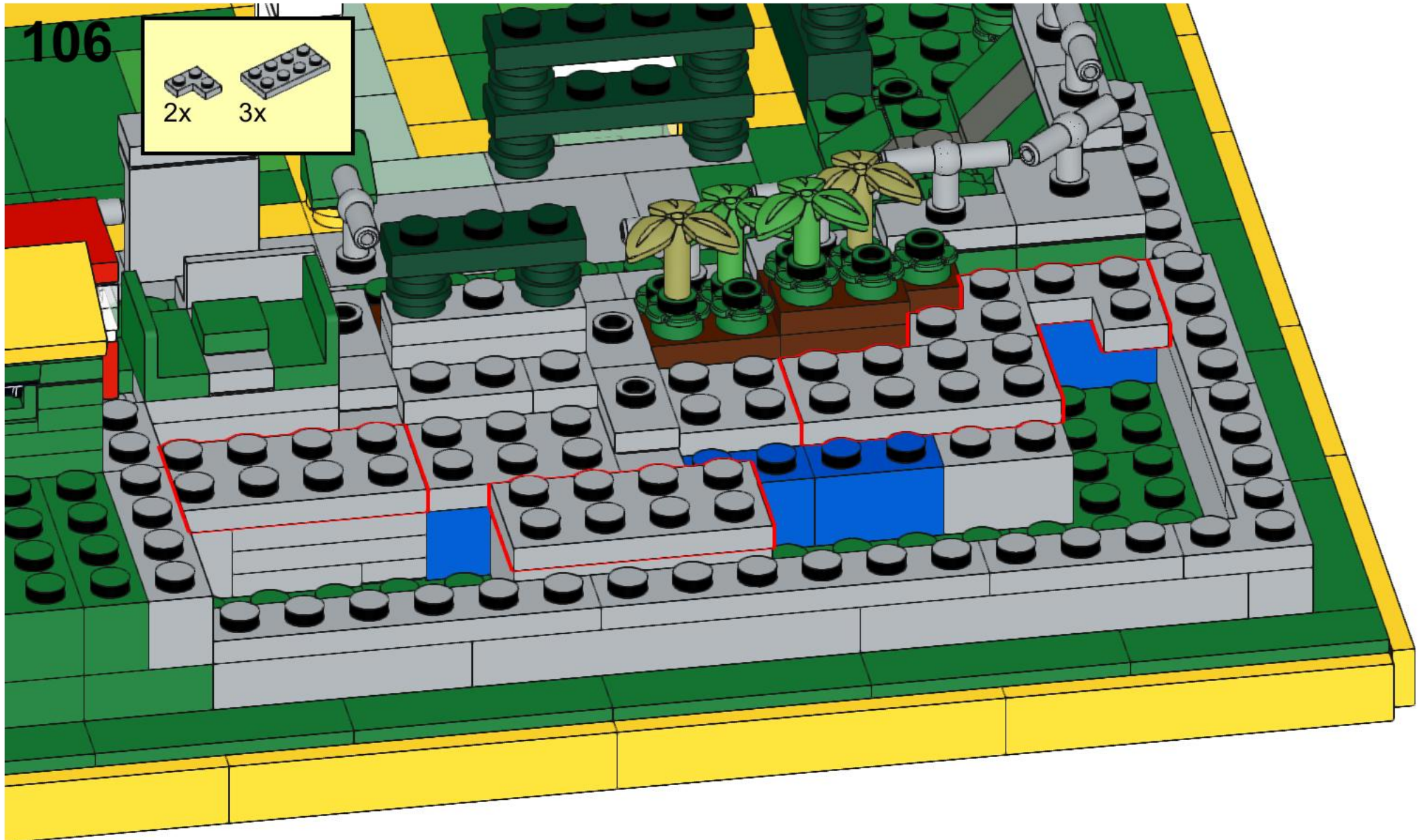

107

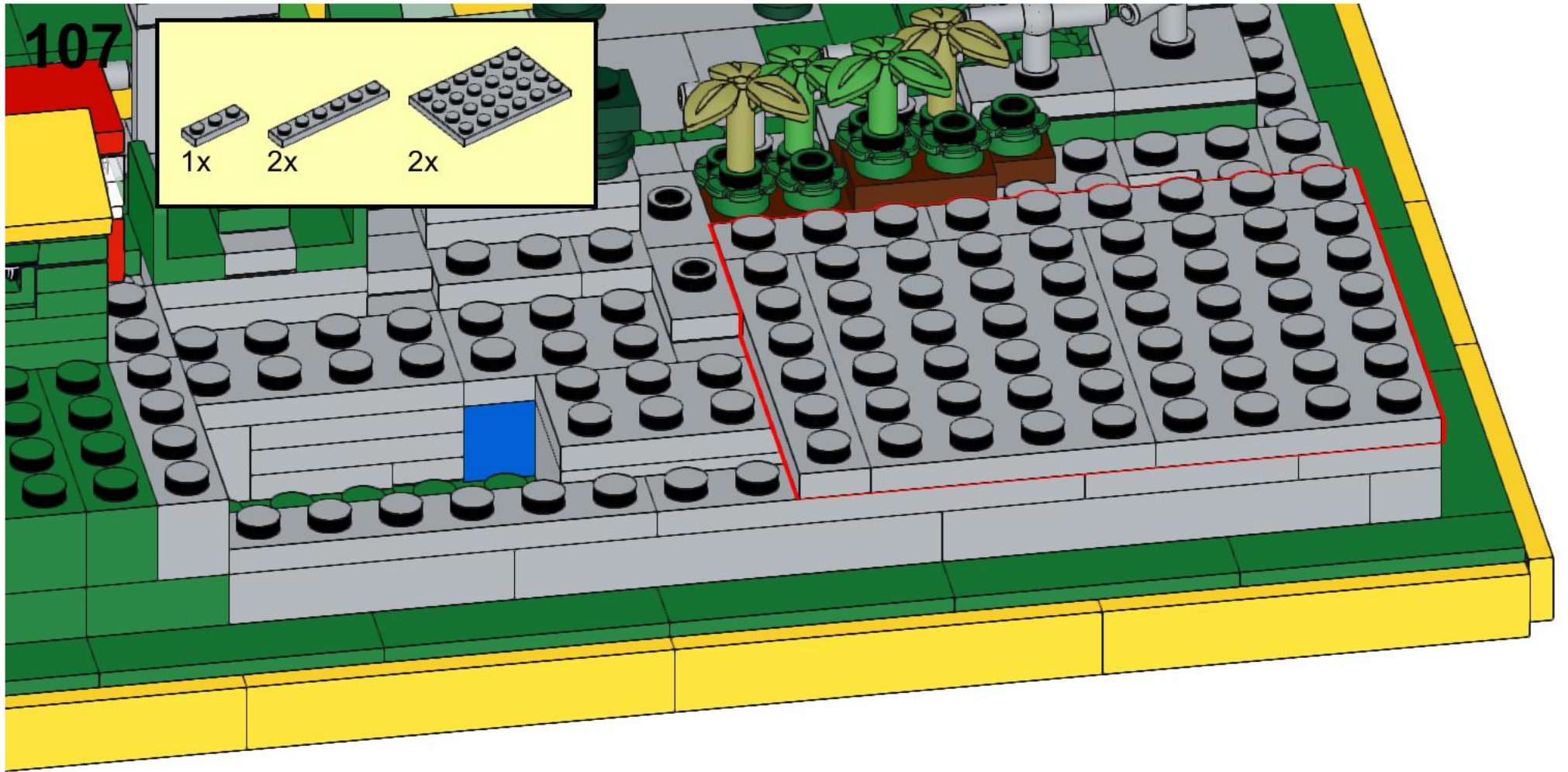
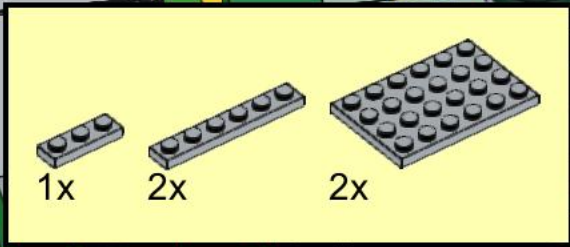

108

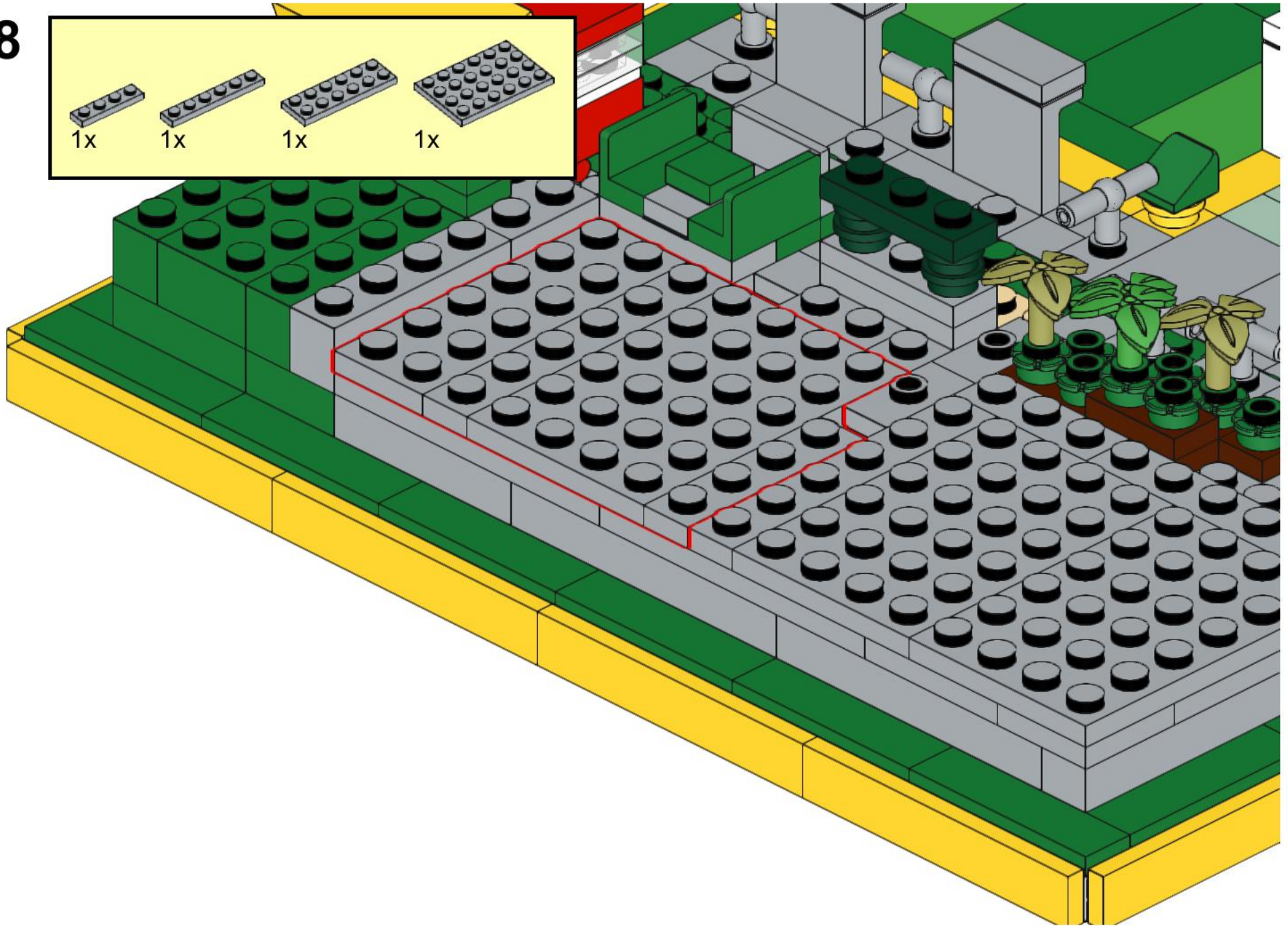
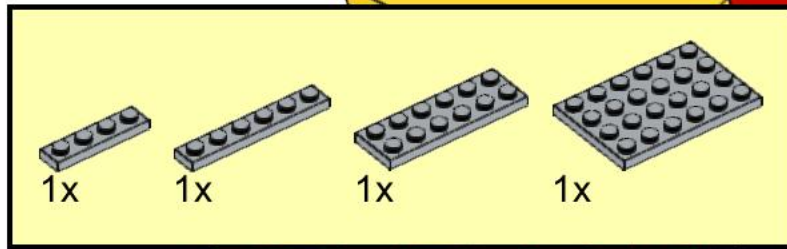

109

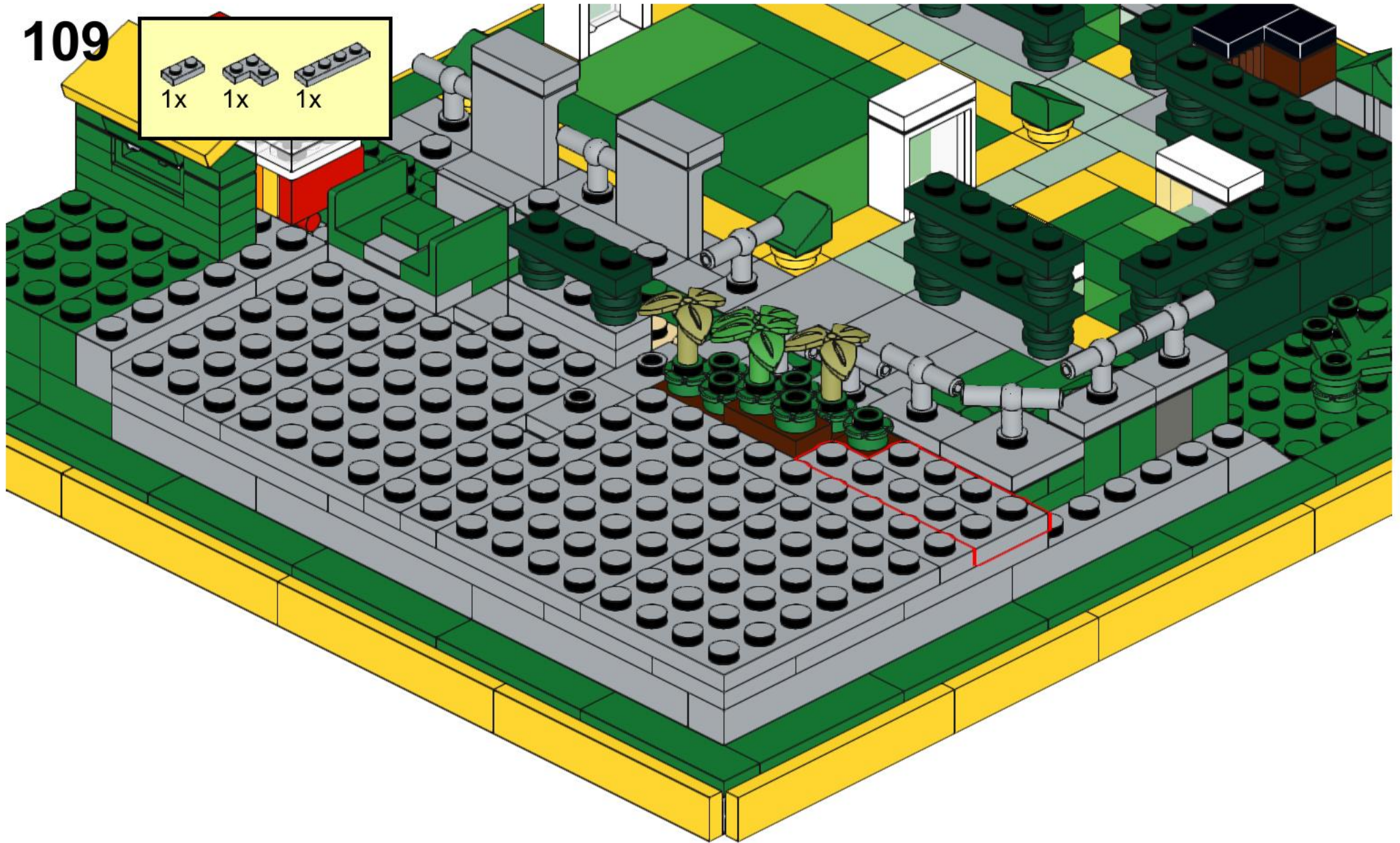
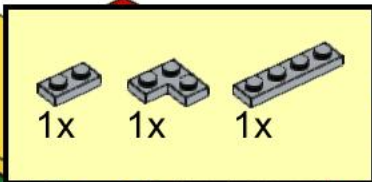

4

110

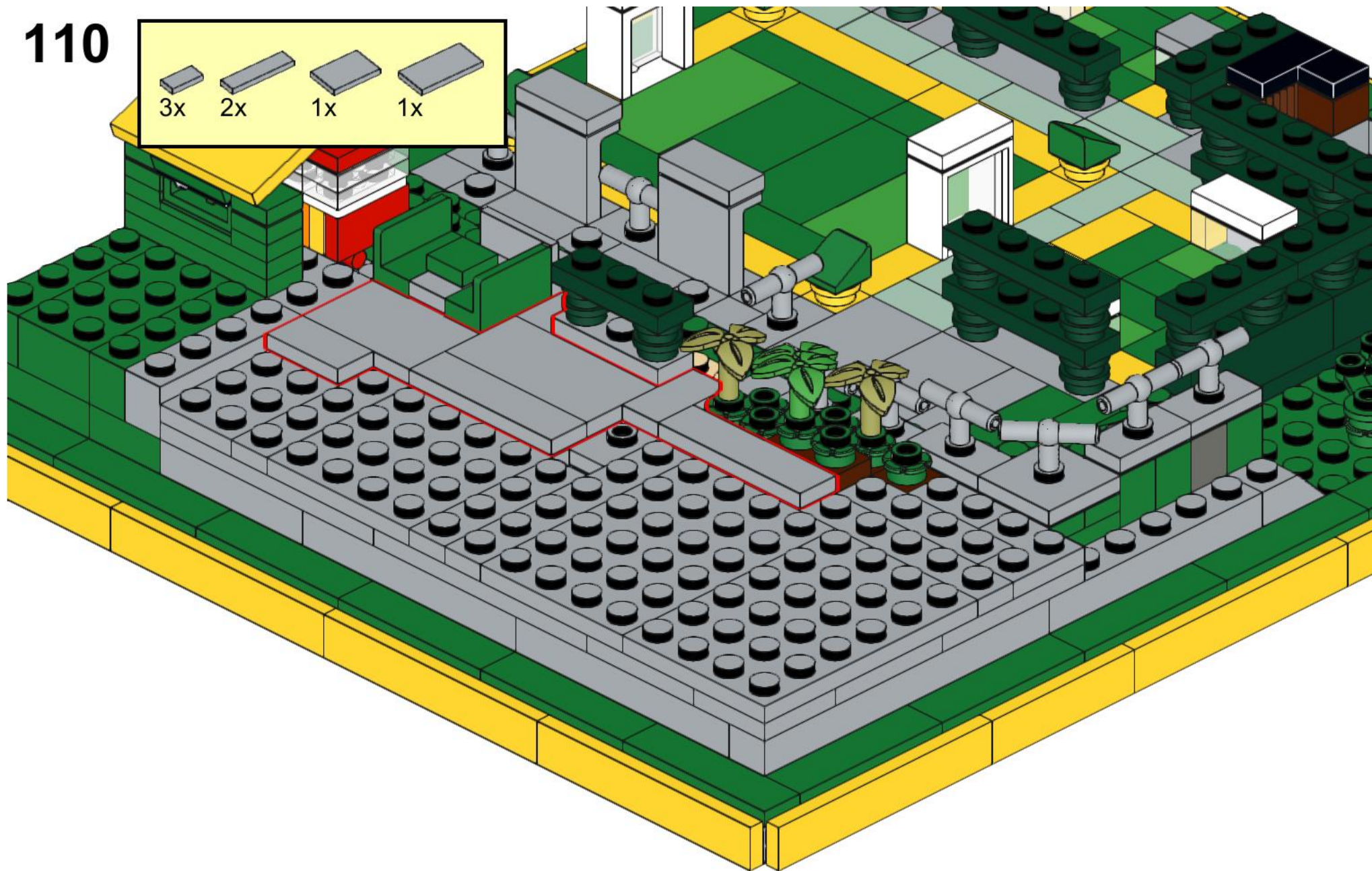
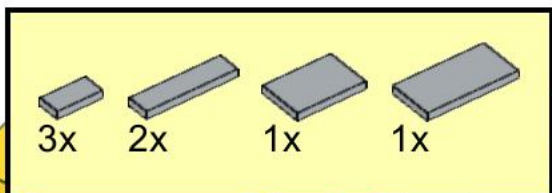

111

1x 1x 1x 1x 2x 1x

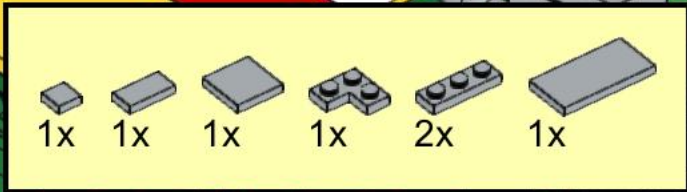
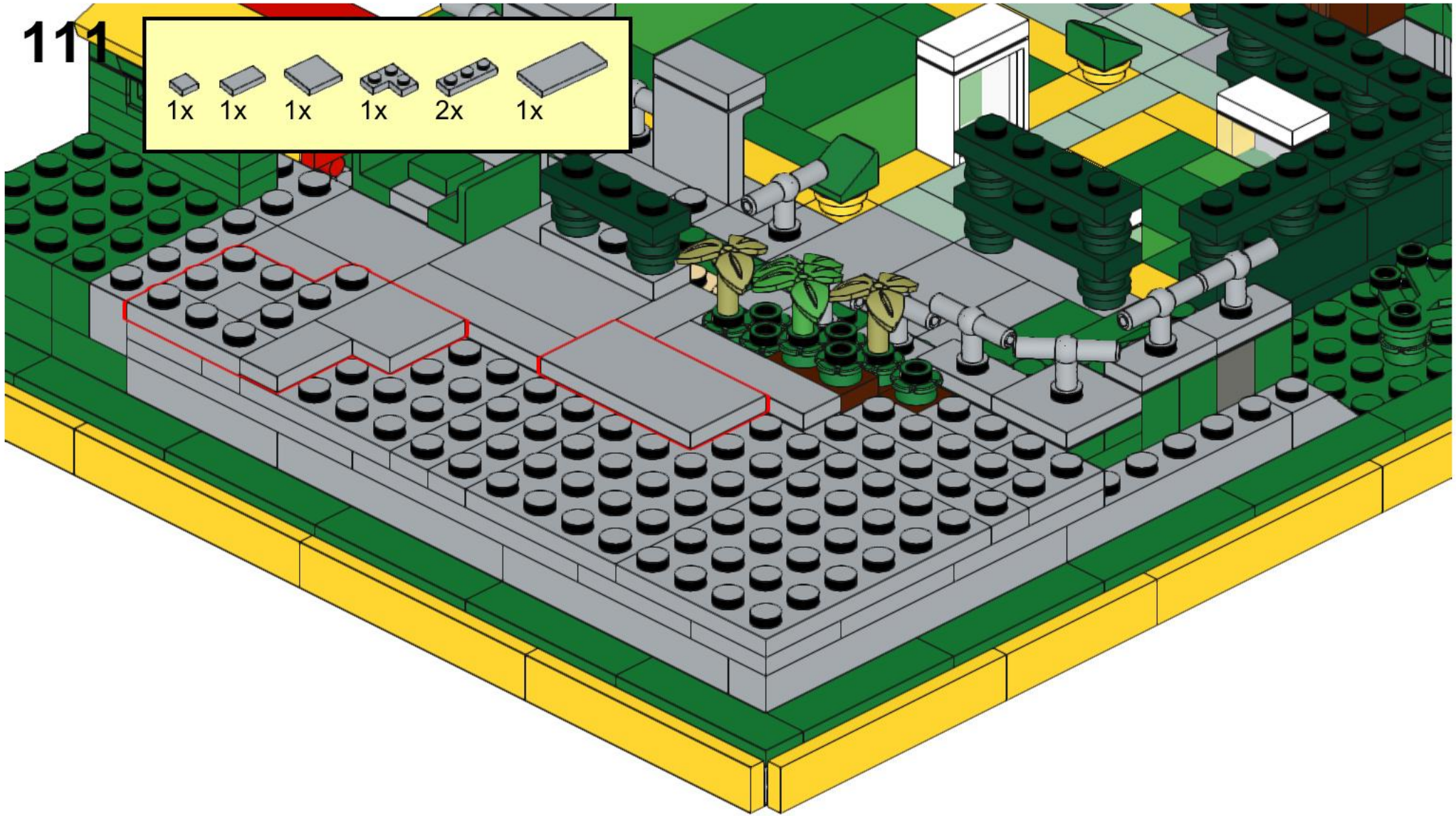
A yellow rectangular box containing a list of six grey LEGO parts. From left to right: a 1x1 square, a 1x2 rectangle, a 1x3 rectangle, a 1x2 T-shaped piece, a 1x2 piece with two holes, and a 1x4 rectangle. Each part is accompanied by a quantity label: '1x', '1x', '1x', '1x', '2x', and '1x' respectively.

112

1x 3x 1x 2x 2x 1x 1x 1x

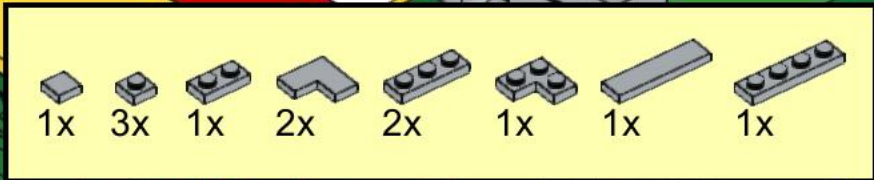
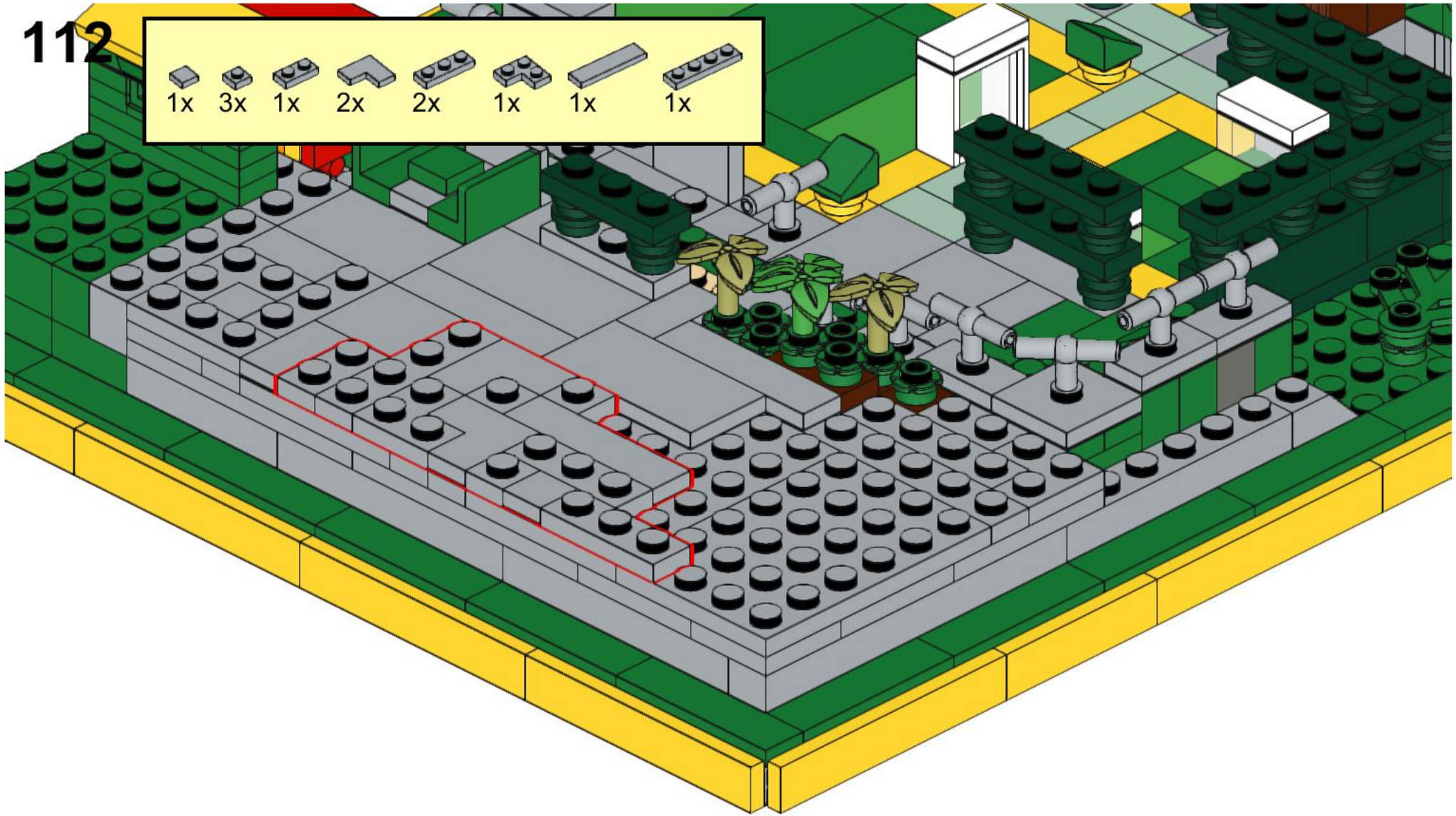
A yellow rectangular box containing a list of LEGO parts with their respective quantities. From left to right: a 1x1 grey square, 3x1 grey Technic pins, a 1x2 grey Technic pin, a 2x2 grey L-shaped Technic pin, a 2x1 grey Technic pin, a 1x2 grey Technic pin, a 1x3 grey Technic pin, and a 1x4 grey Technic pin.

113

3x 1x 2x 1x 1x

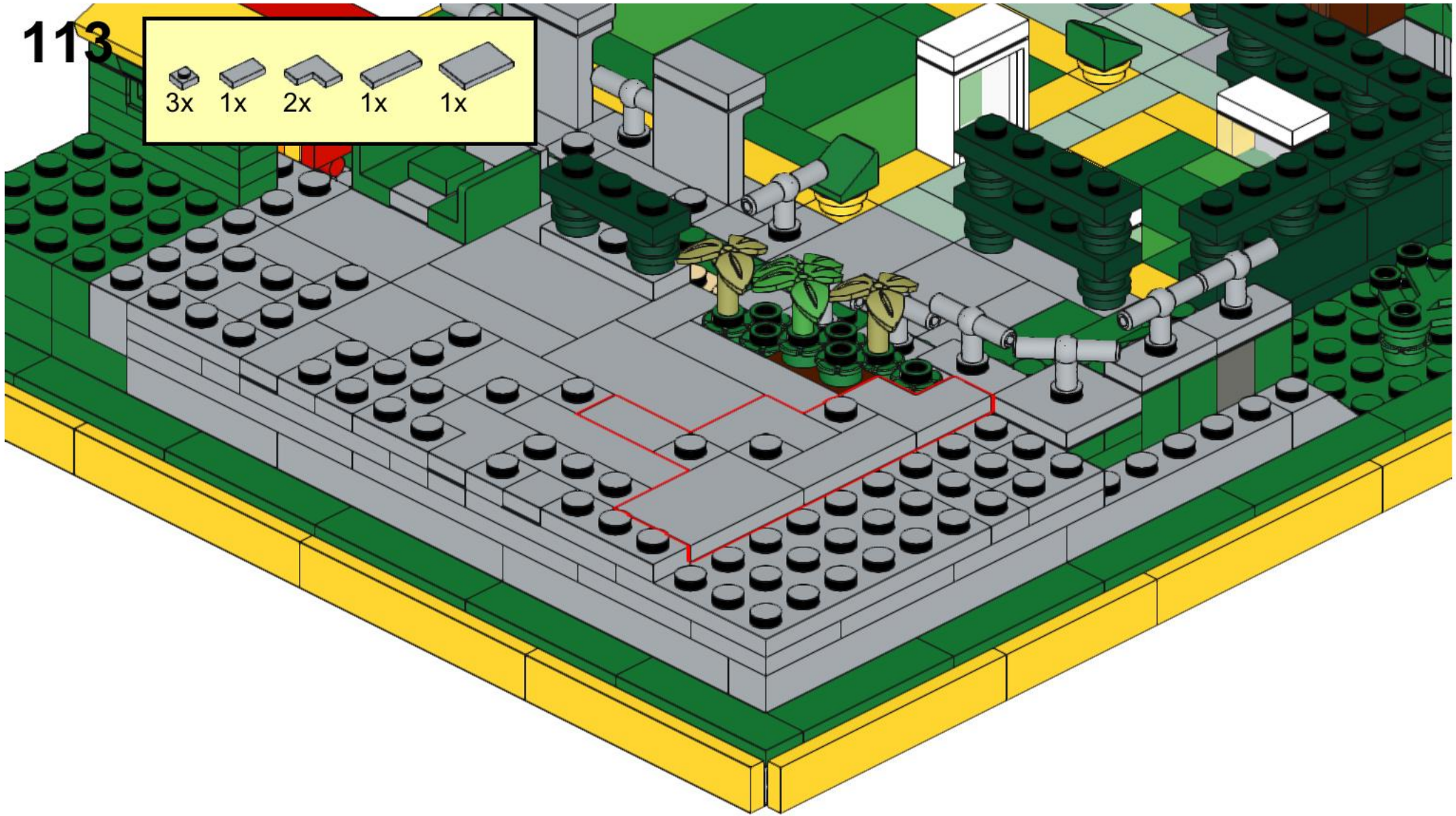
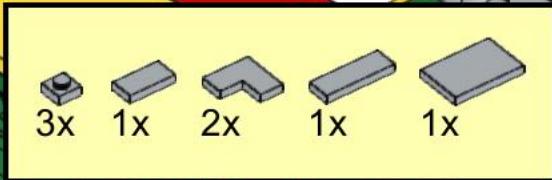

114

1x 1x 1x 4x 1x 2x 1x

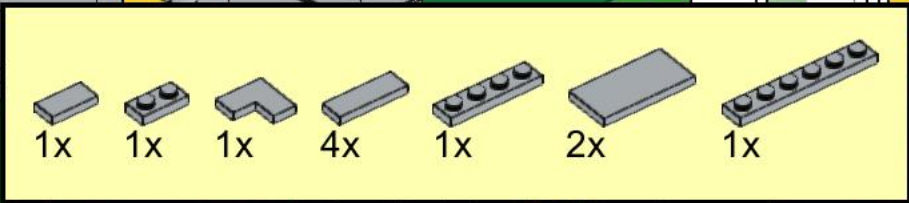
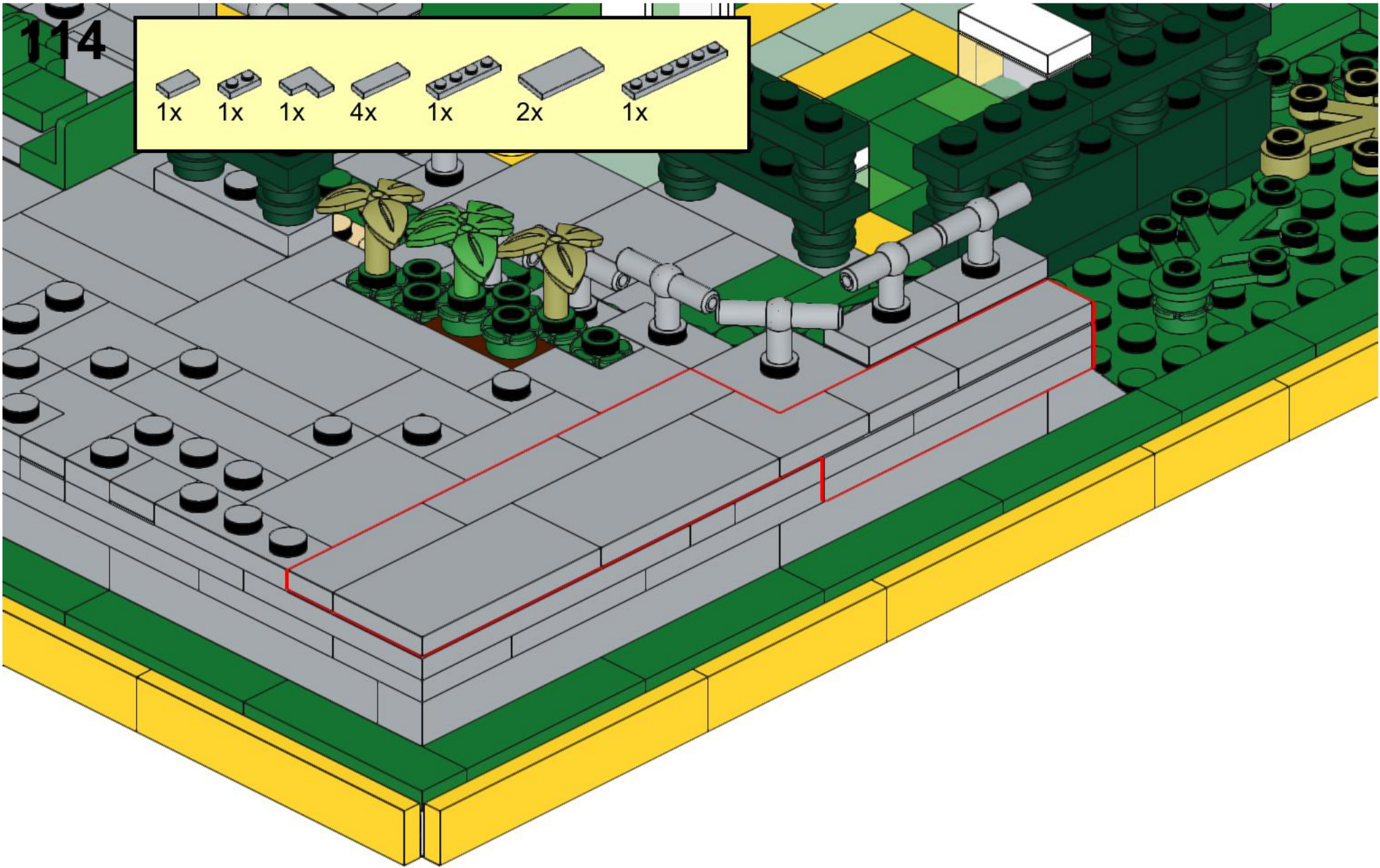
A yellow rectangular box containing a list of LEGO parts with their respective quantities. From left to right: a 1x grey Technic brick (1x), a 1x grey Technic brick with a hole (1x), a 1x grey Technic L-shaped brick (1x), a 4x grey Technic brick (4x), a 1x grey Technic brick with four holes (1x), a 2x grey Technic brick (2x), and a 1x grey Technic brick with five holes (1x).

115

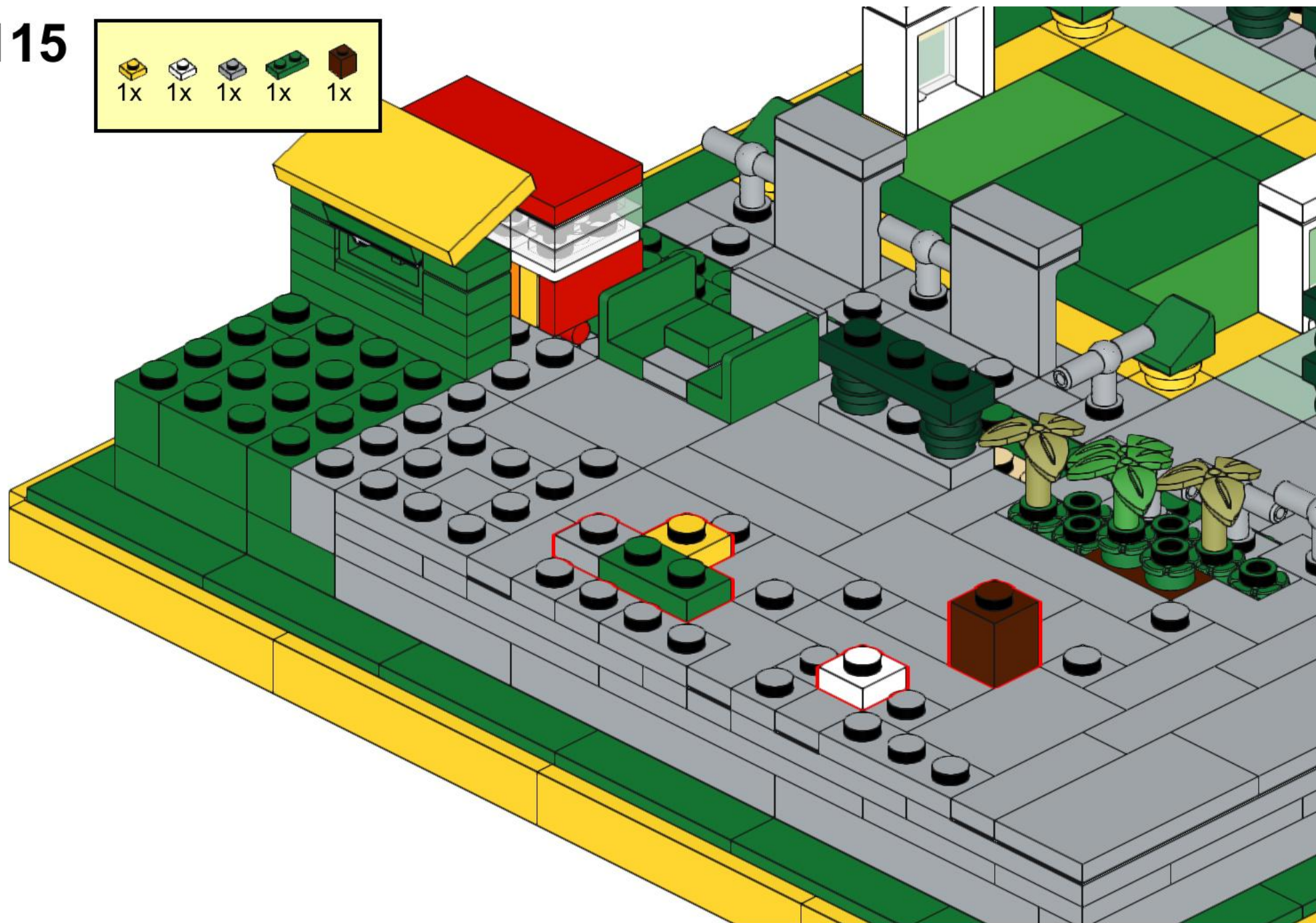
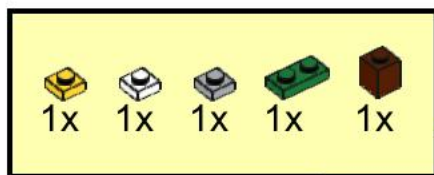

116

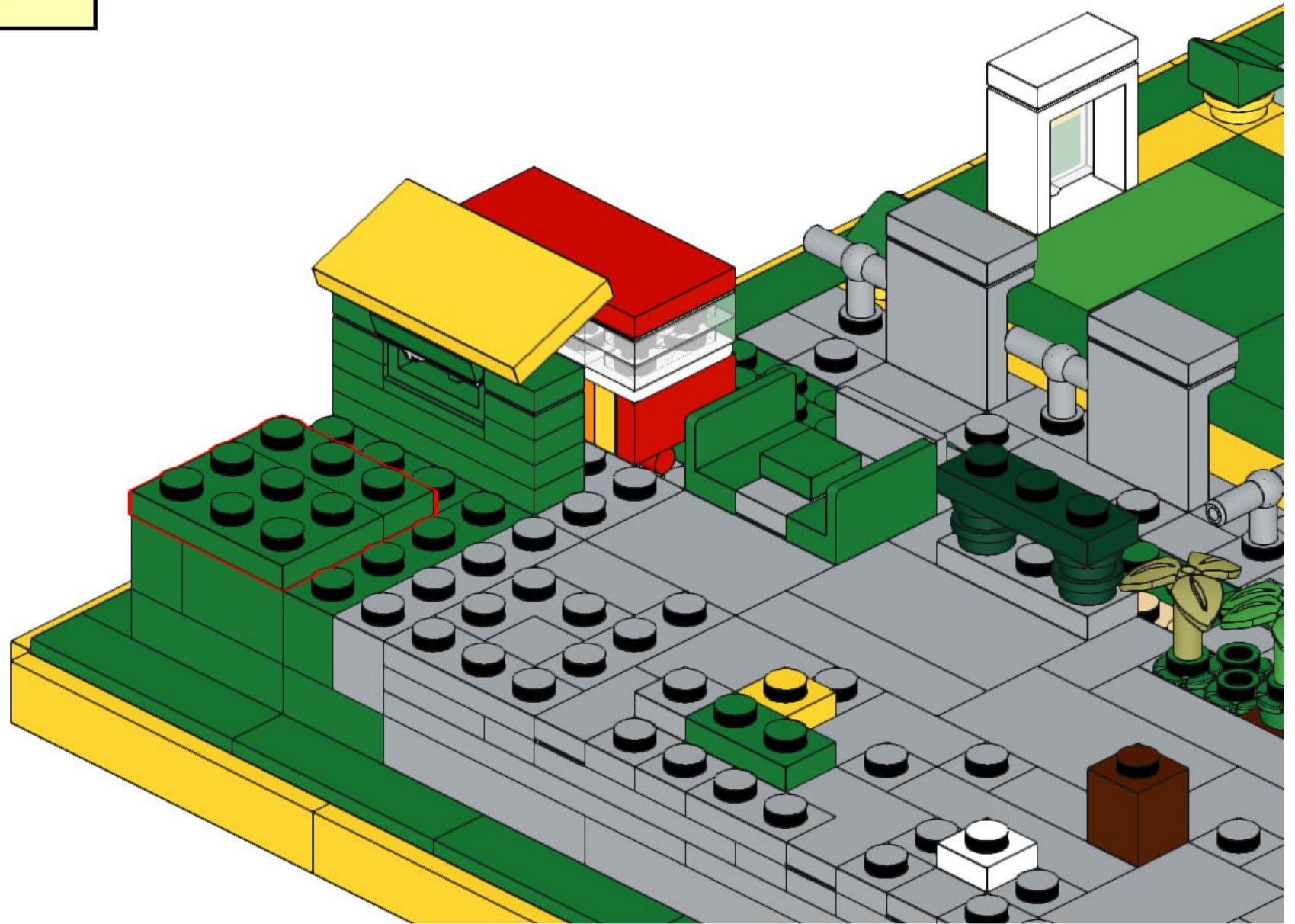
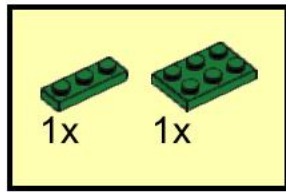

117

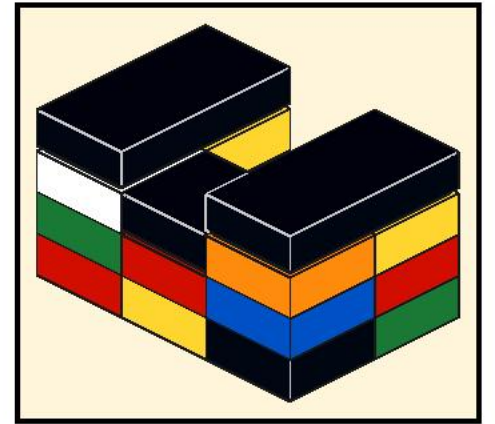
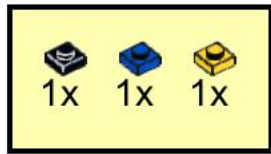

118

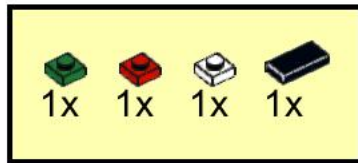

119

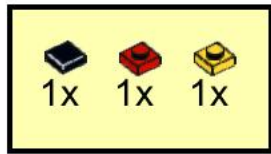

120

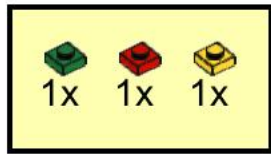

121

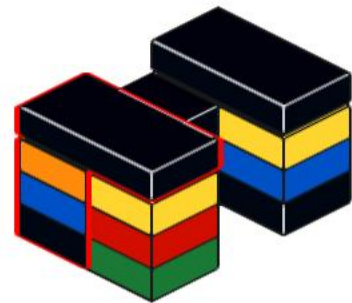
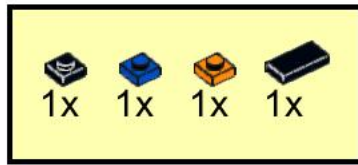

122

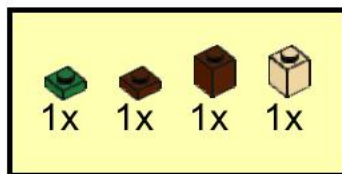

123

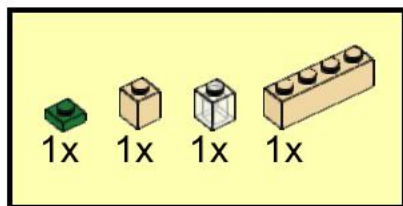

124

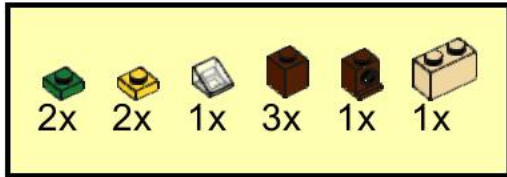

125

1x	1x	1x	1x	1x

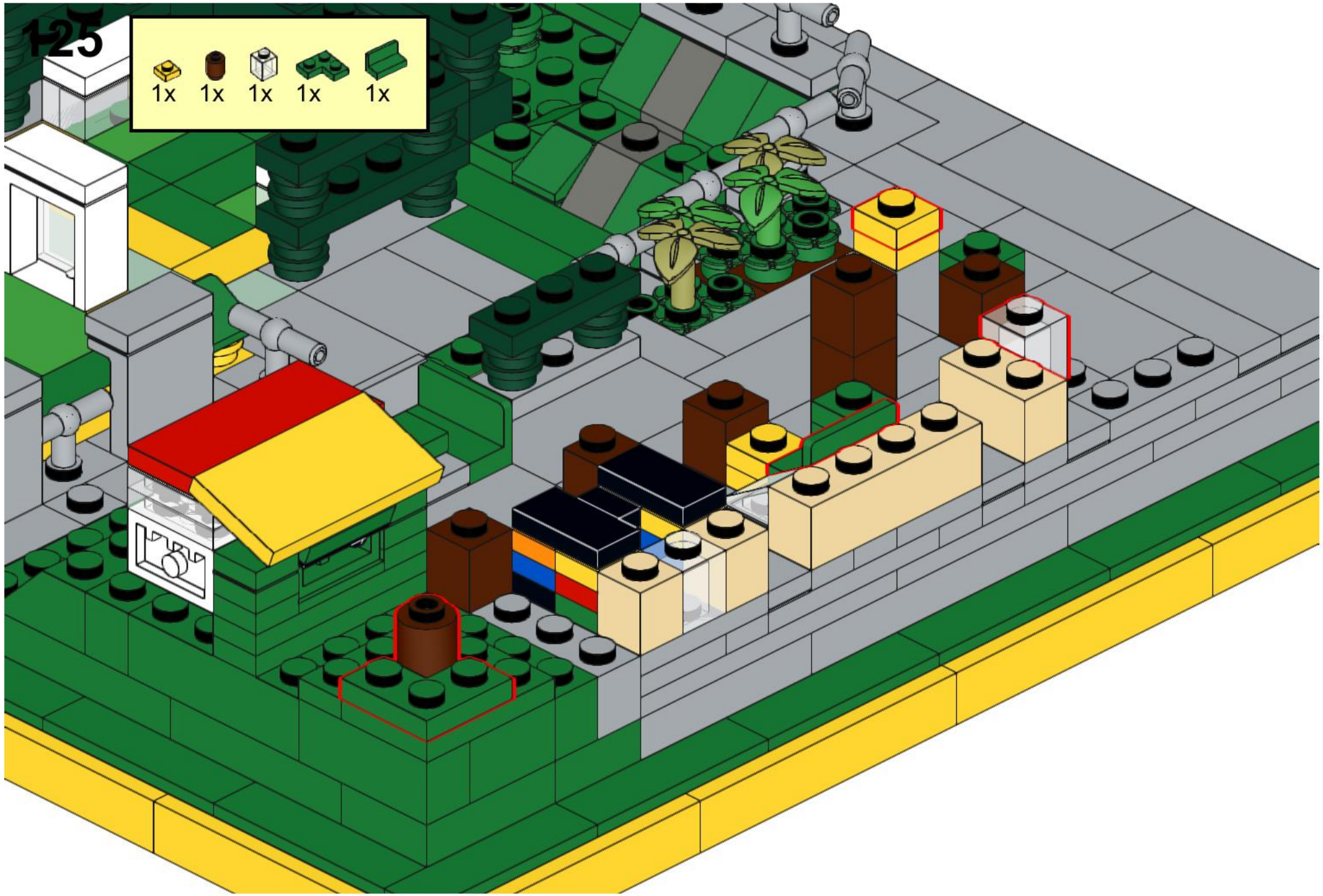

126

2x 2x

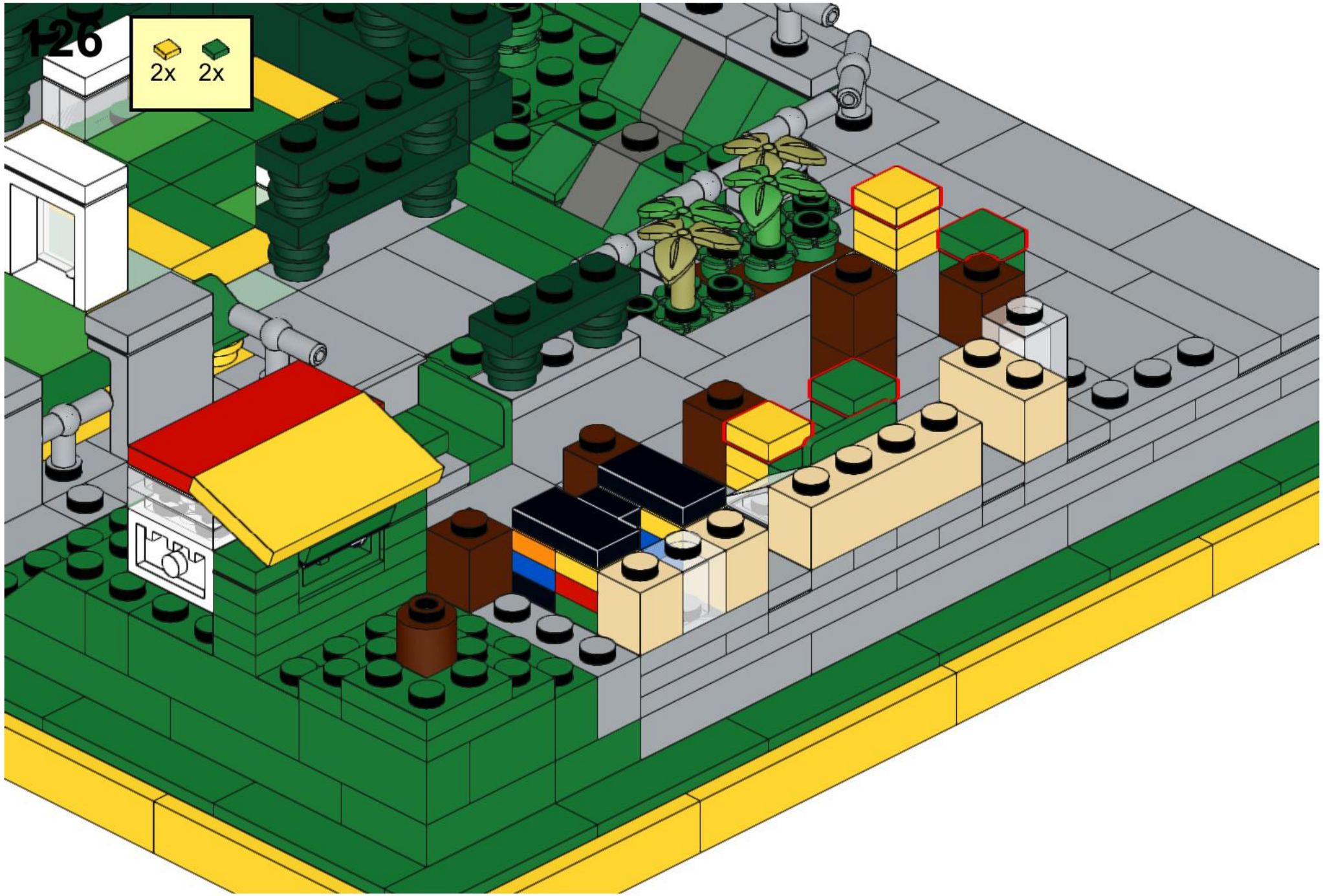
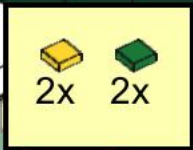

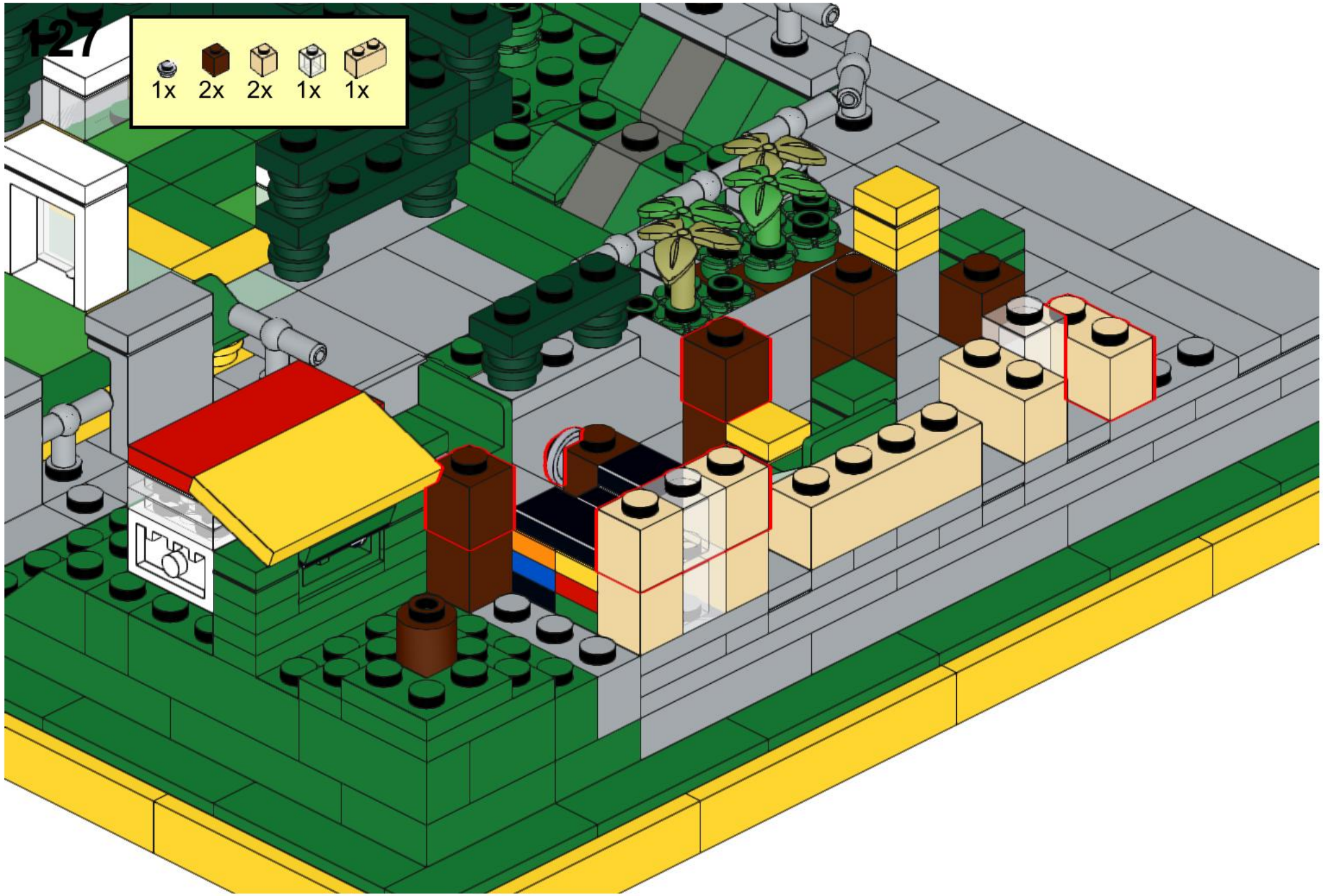

127

- 1x
- 2x
- 2x
- 1x
- 1x

128

1x 1x 2x 1x

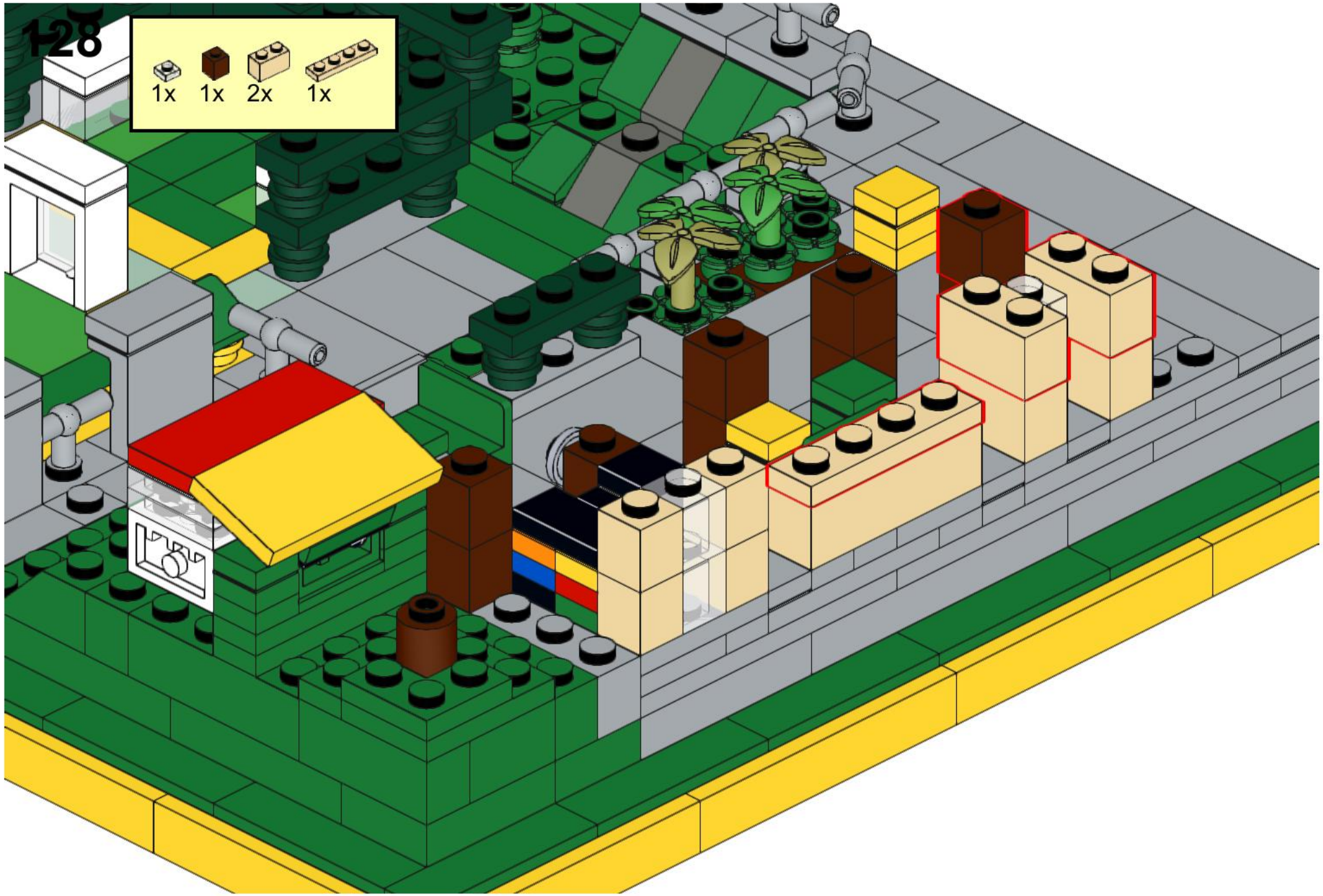
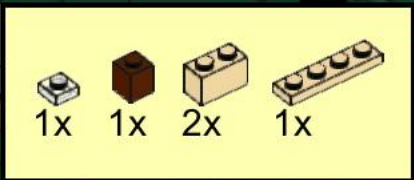

129

- 1x
- 1x
- 1x
- 1x

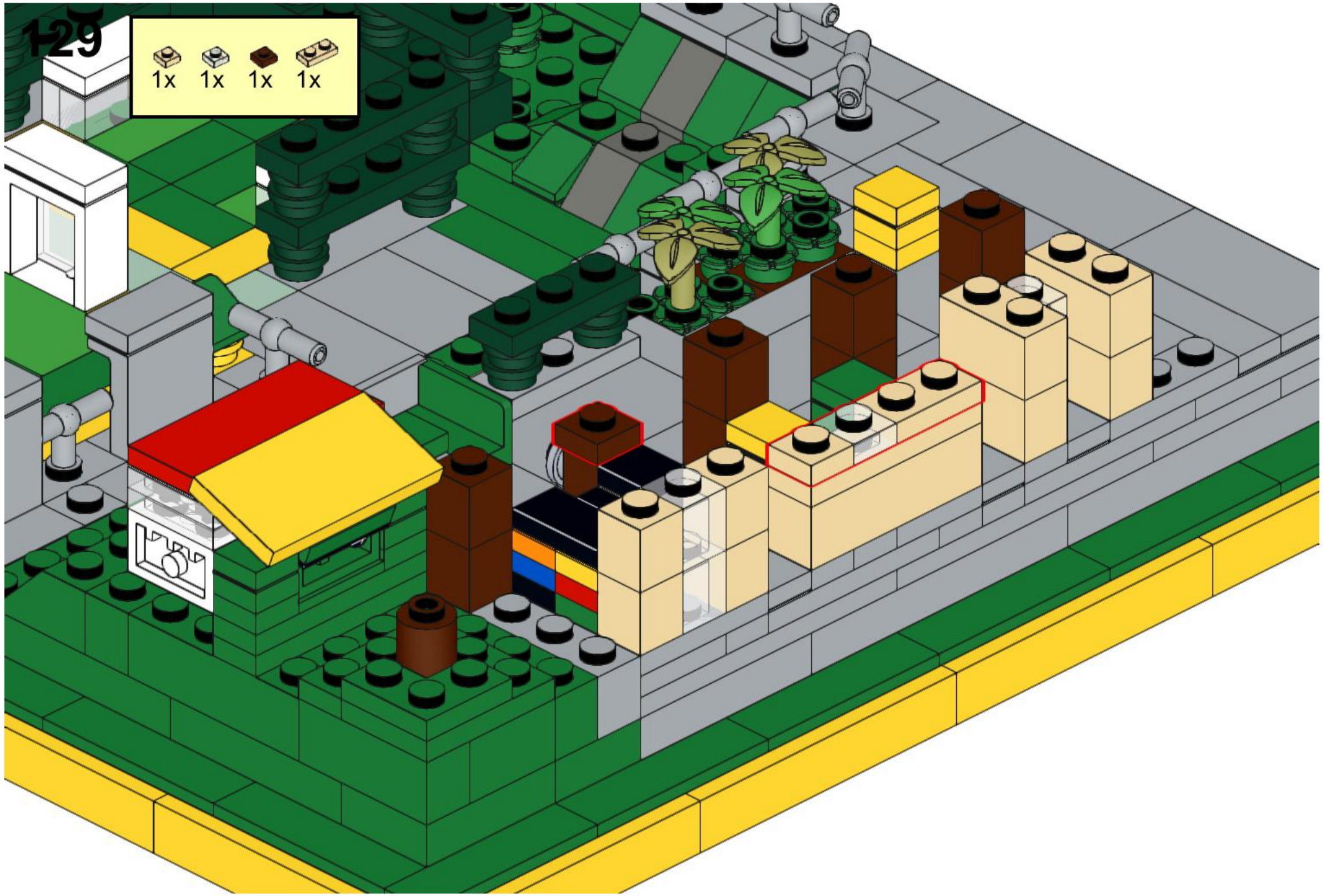

131

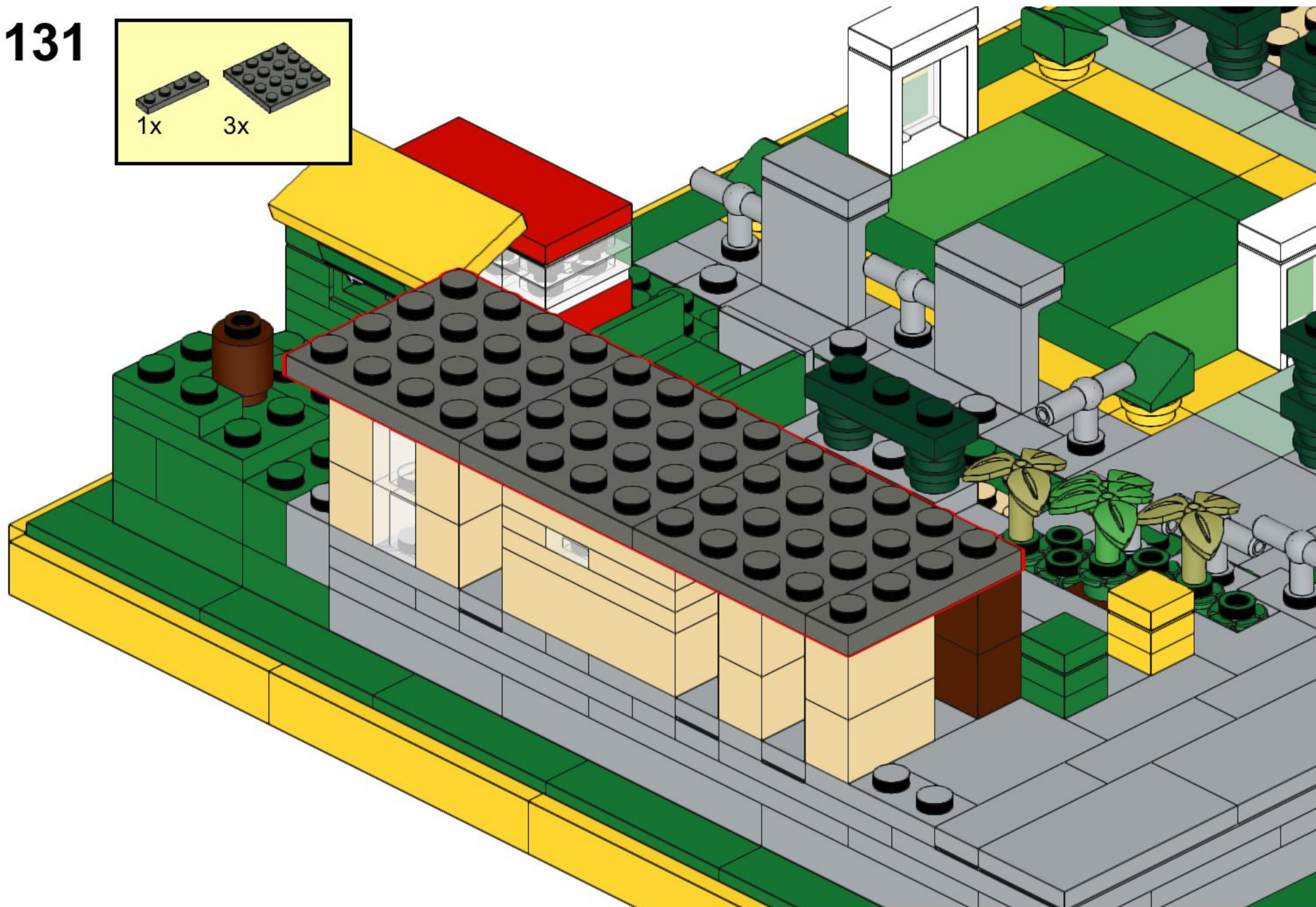
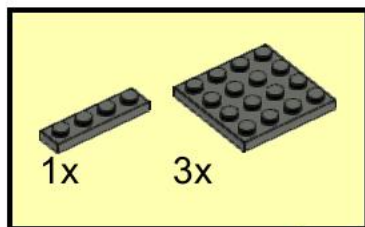

132

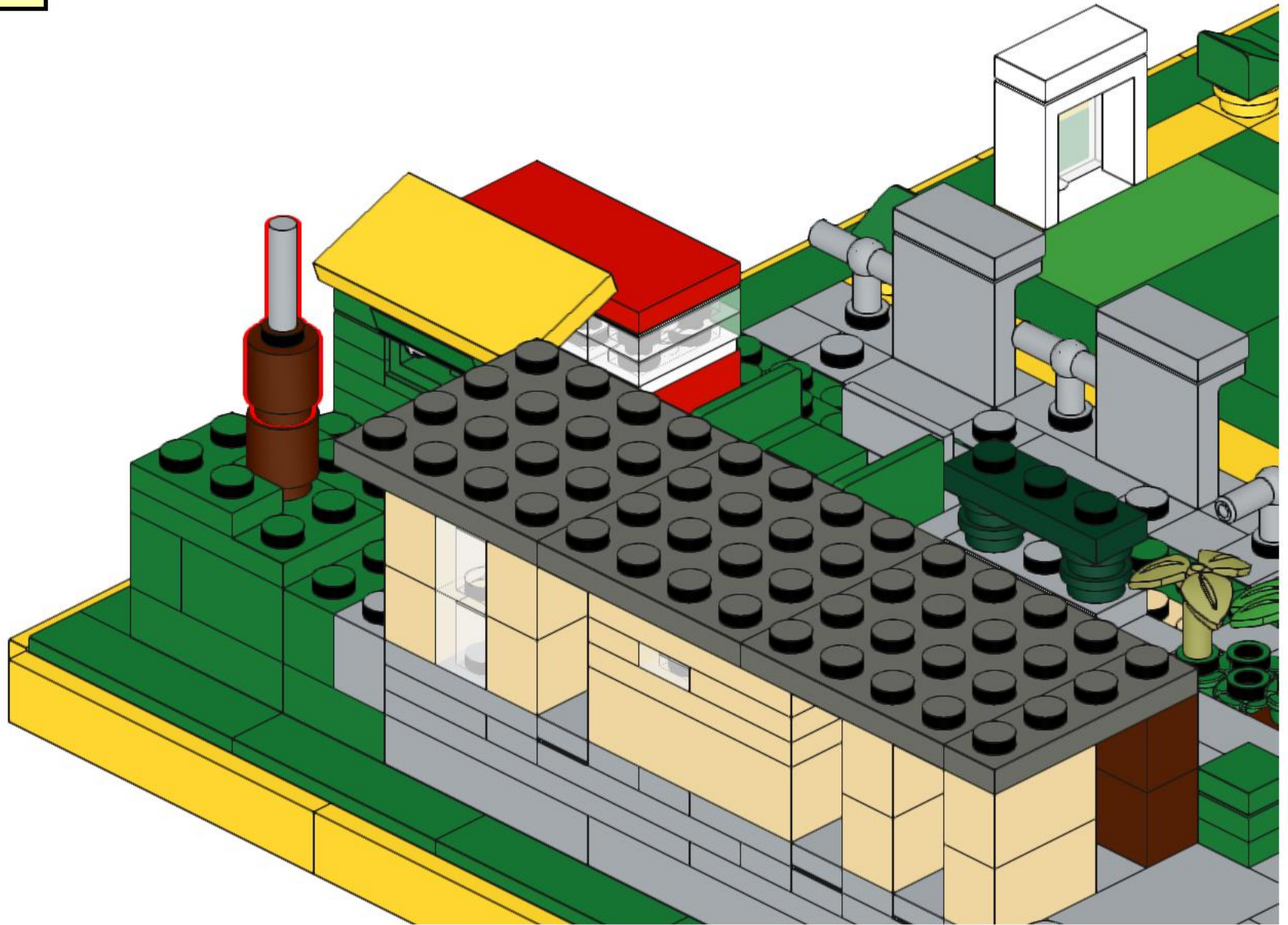
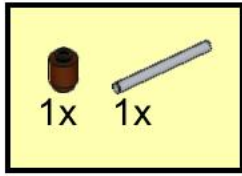

133

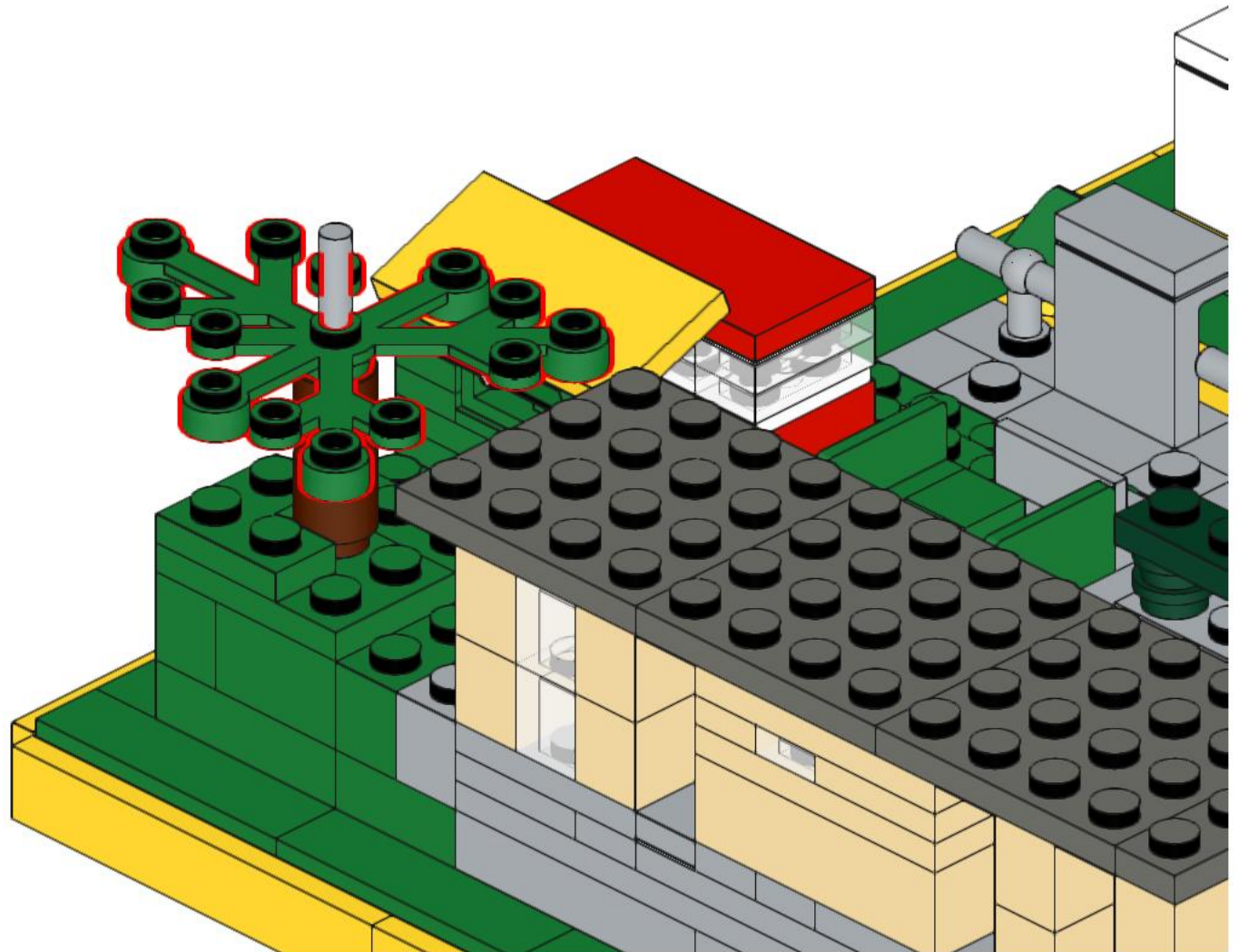
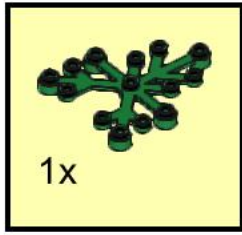

134

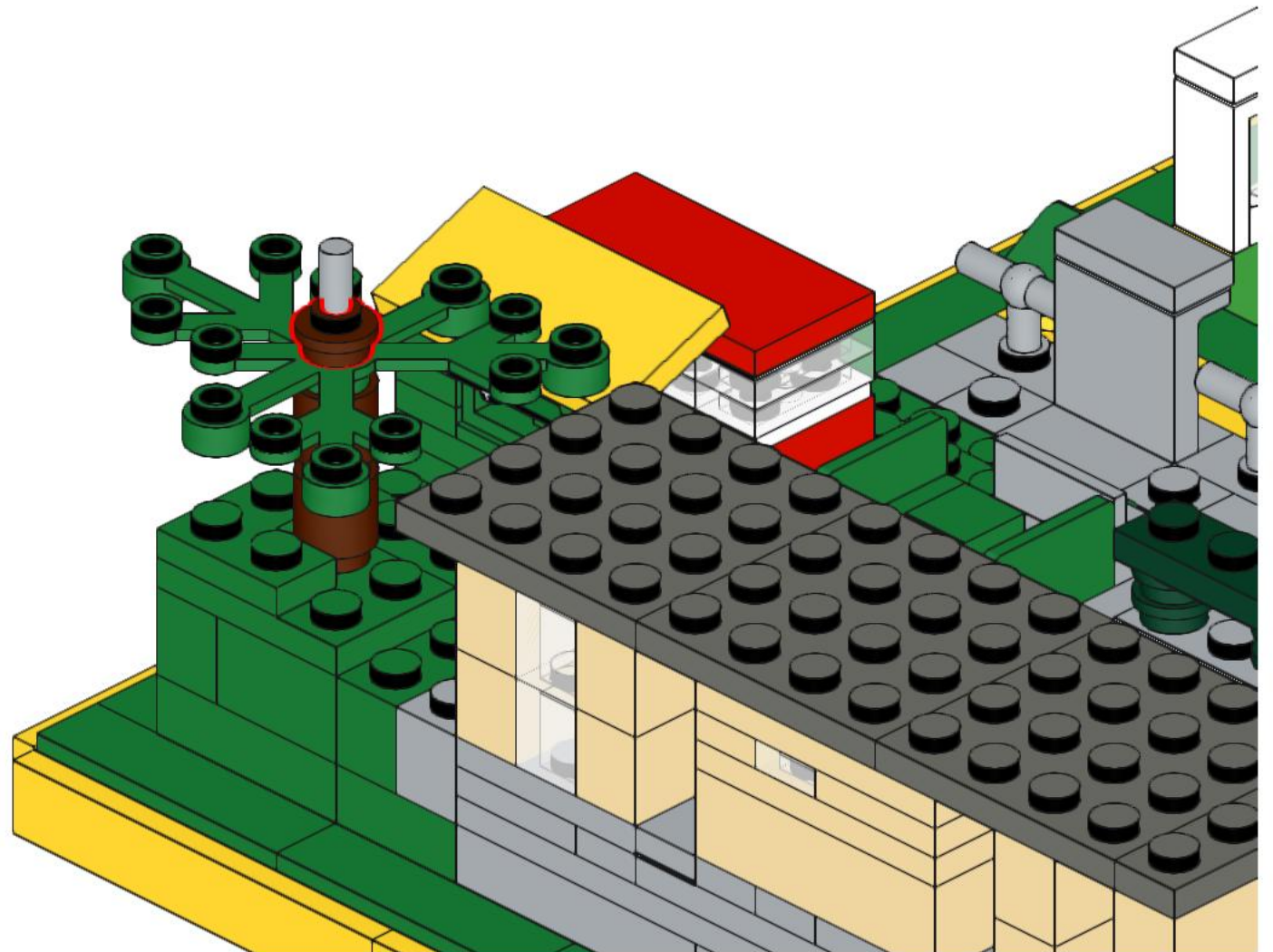
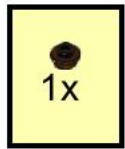

135

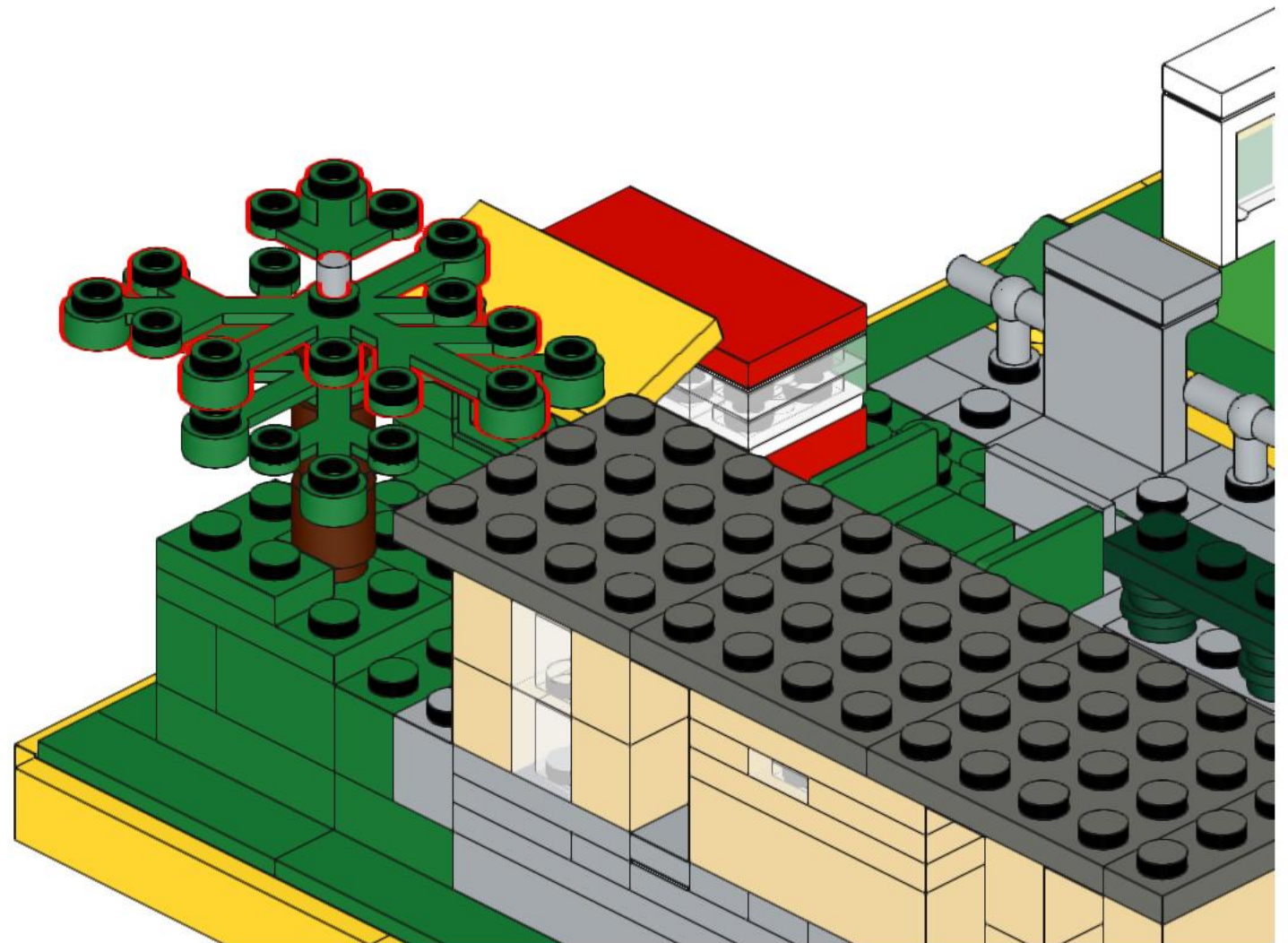
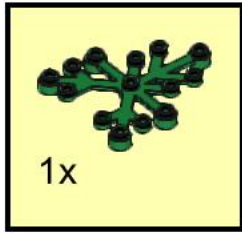

136

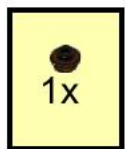

137

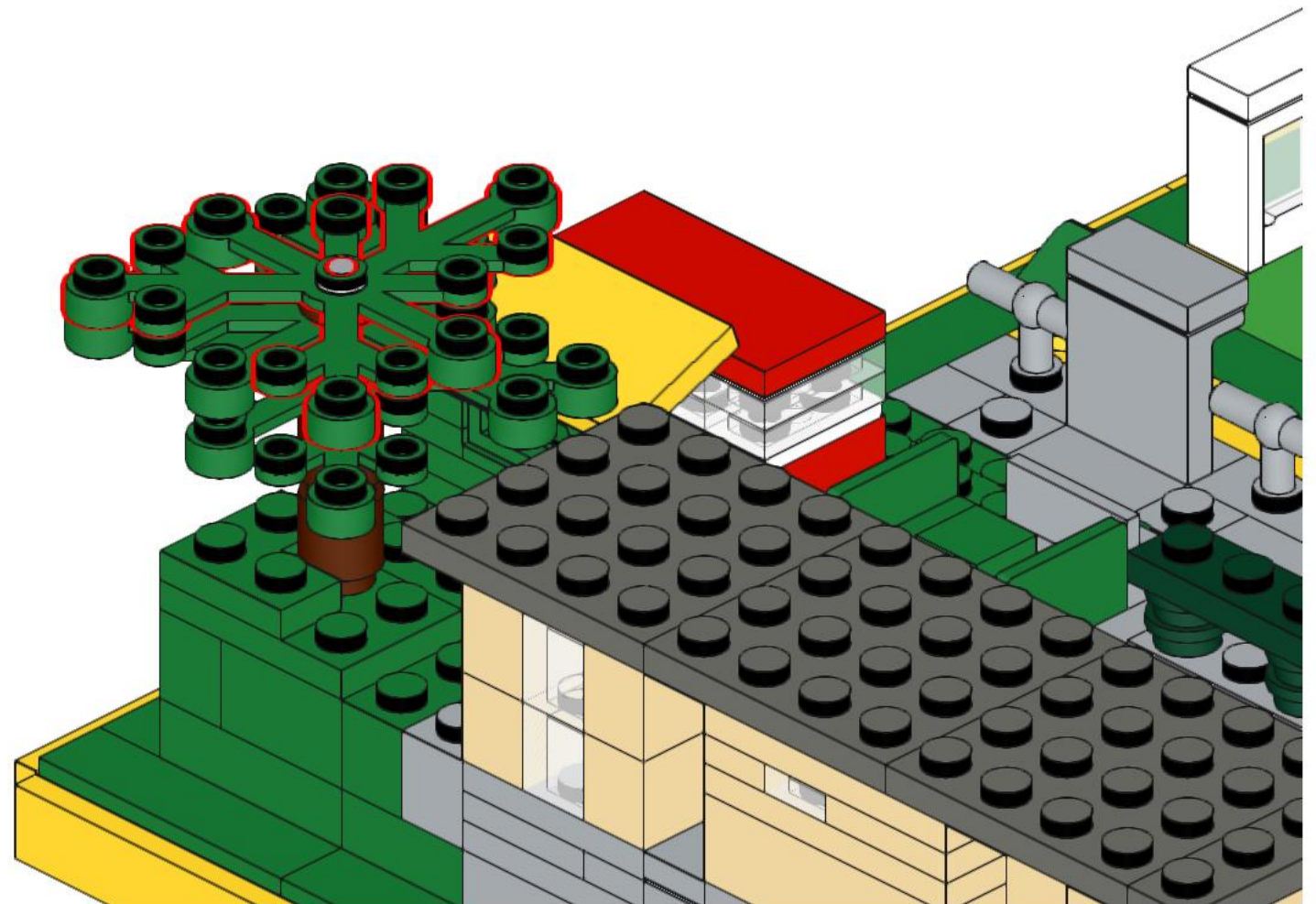
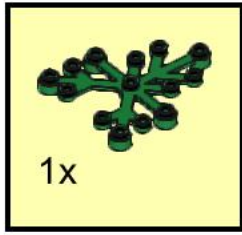

138

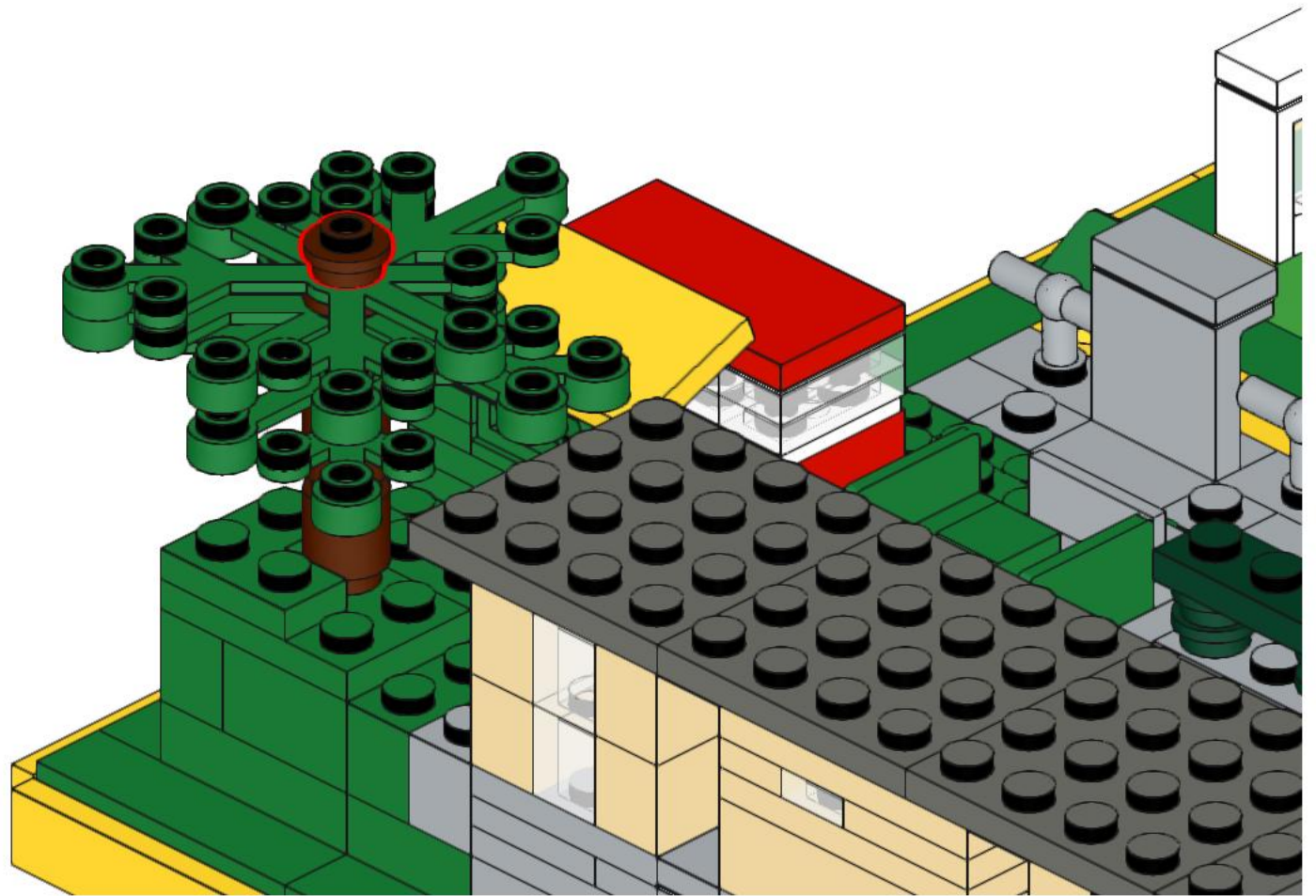

139

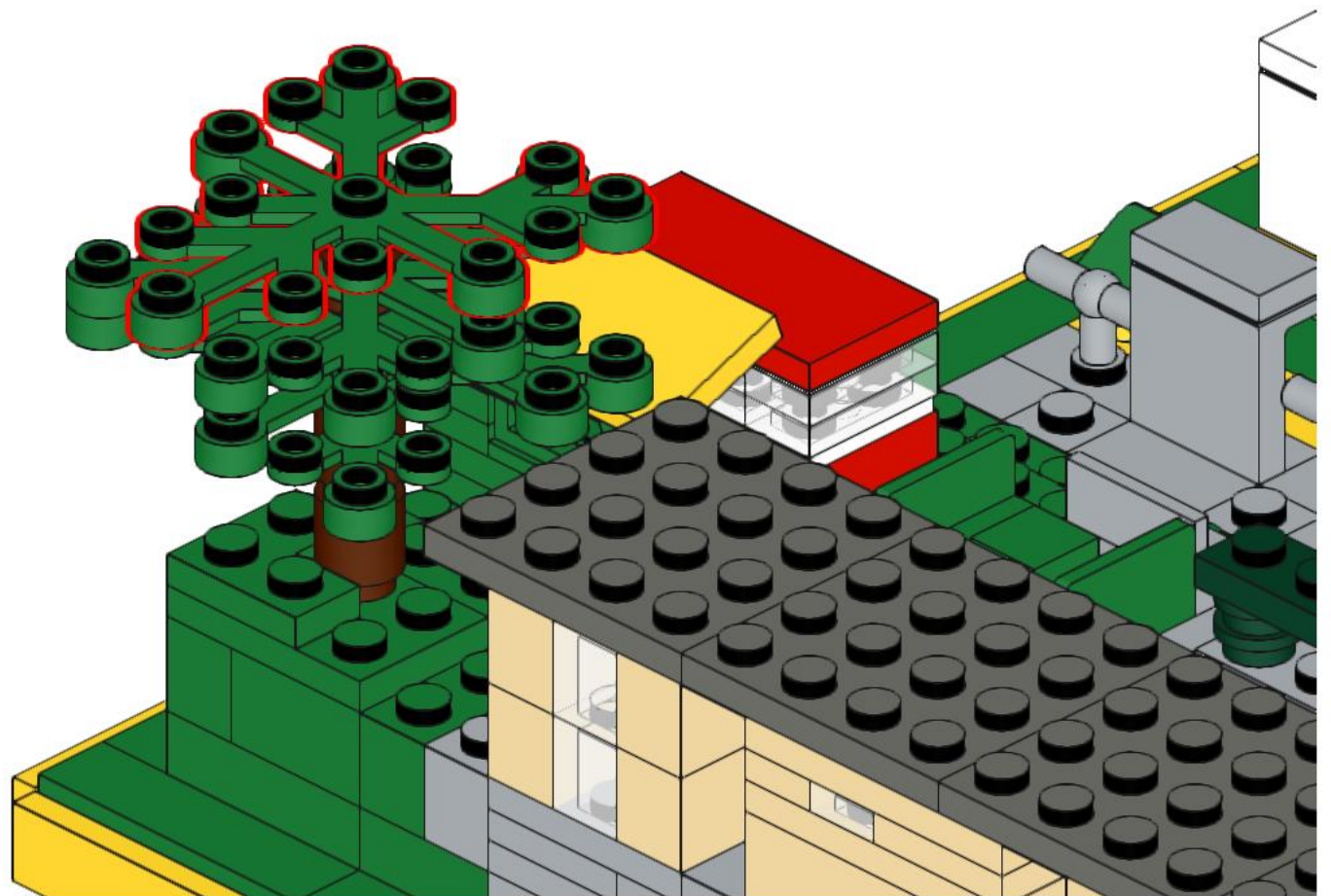
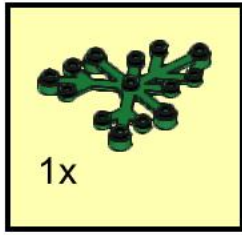

640

1x 2x

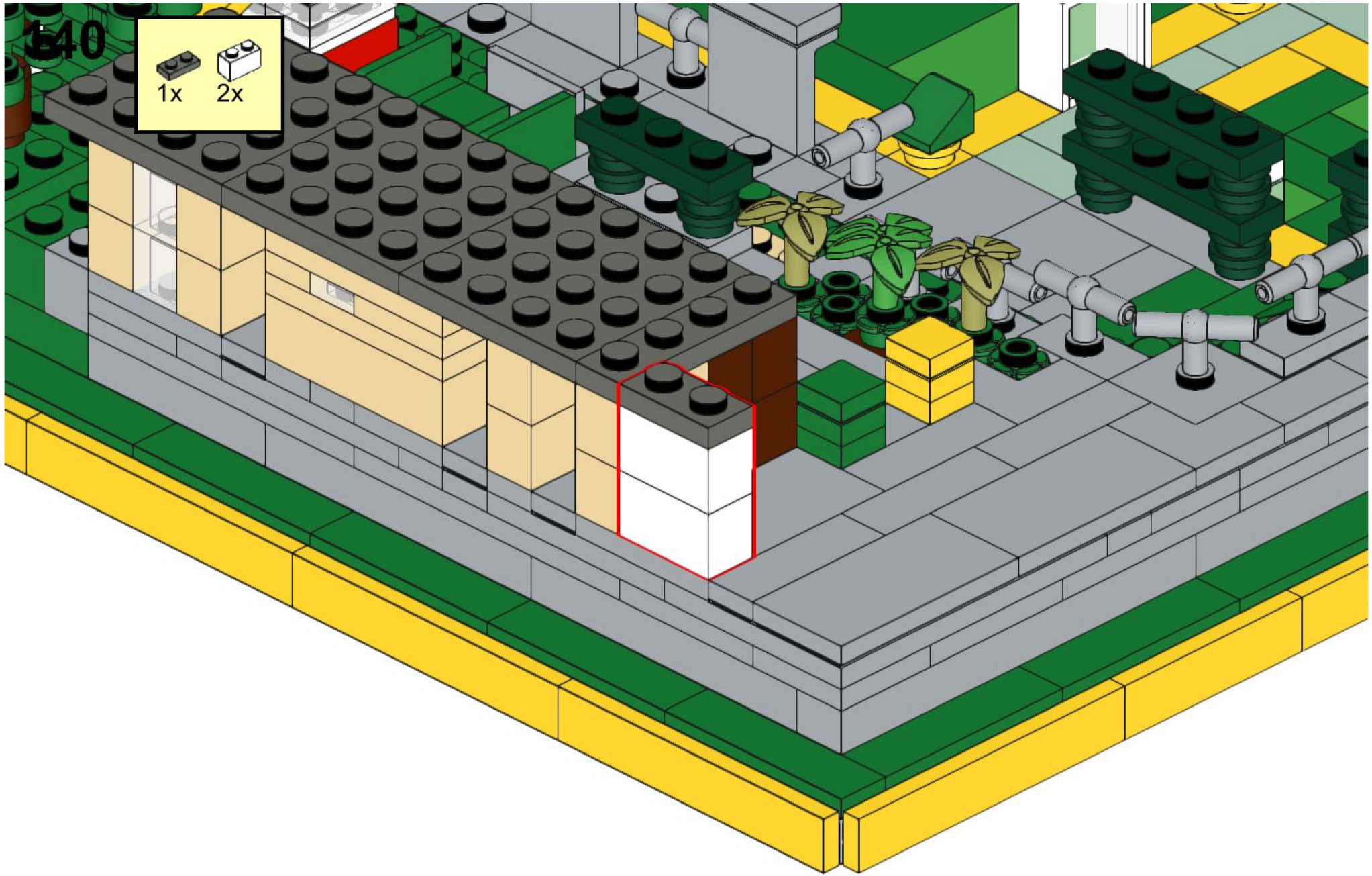
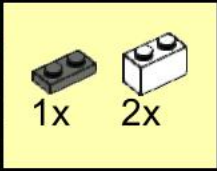

141

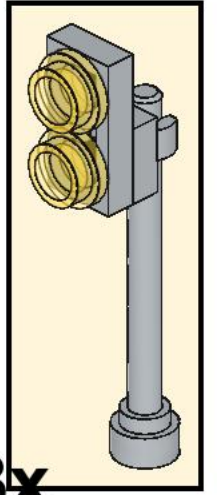
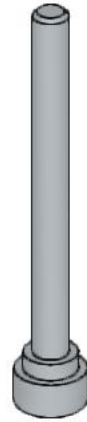
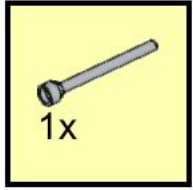

142

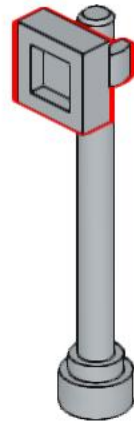
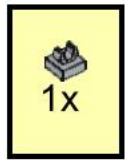

143

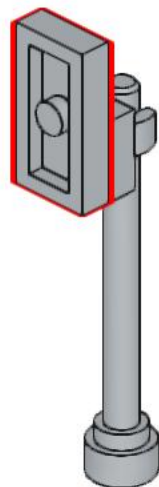
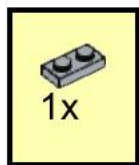

144

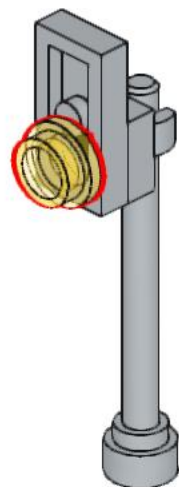

145

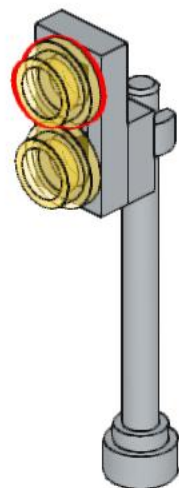
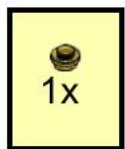

146

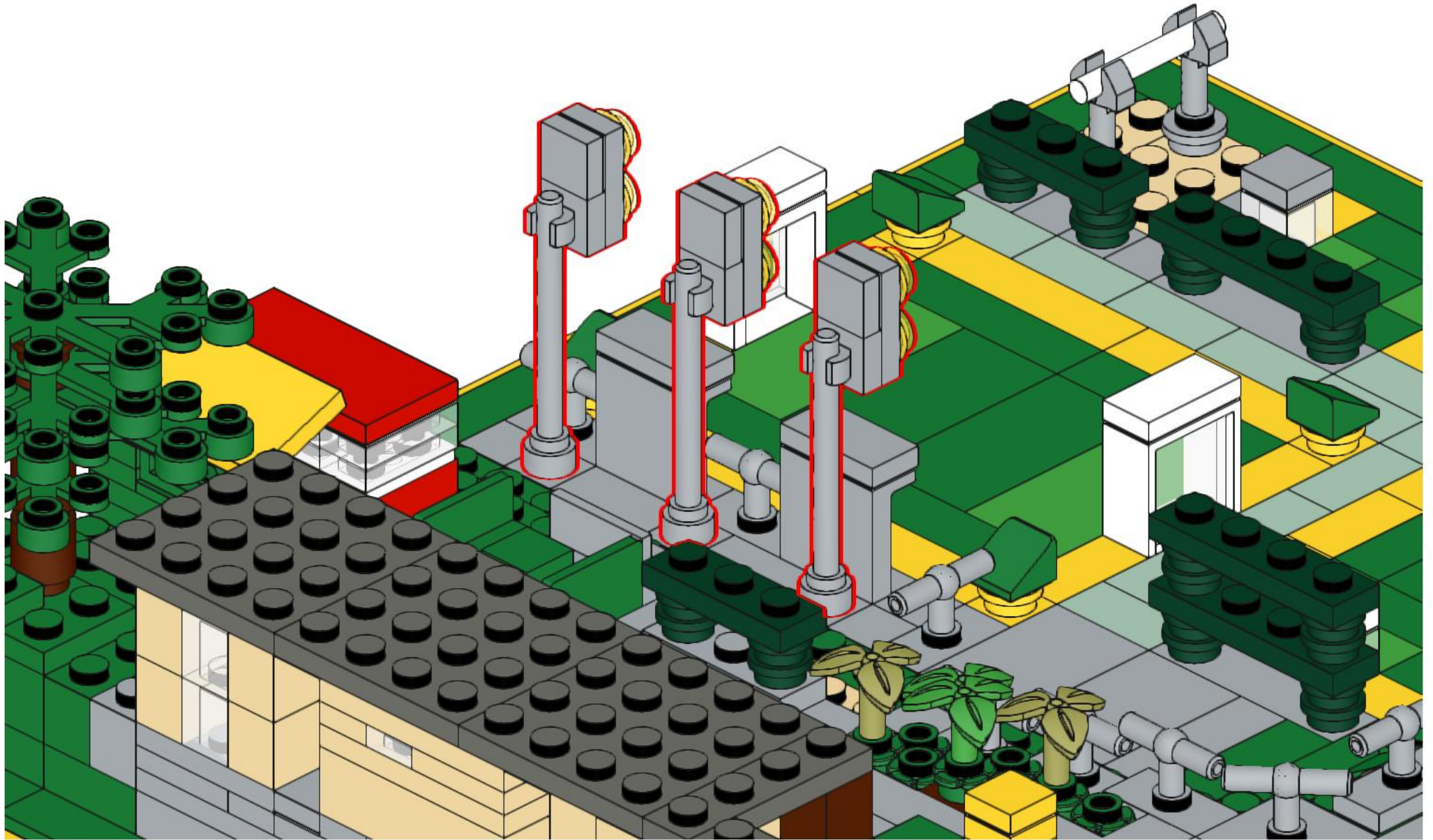
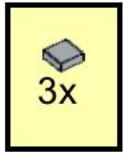

147

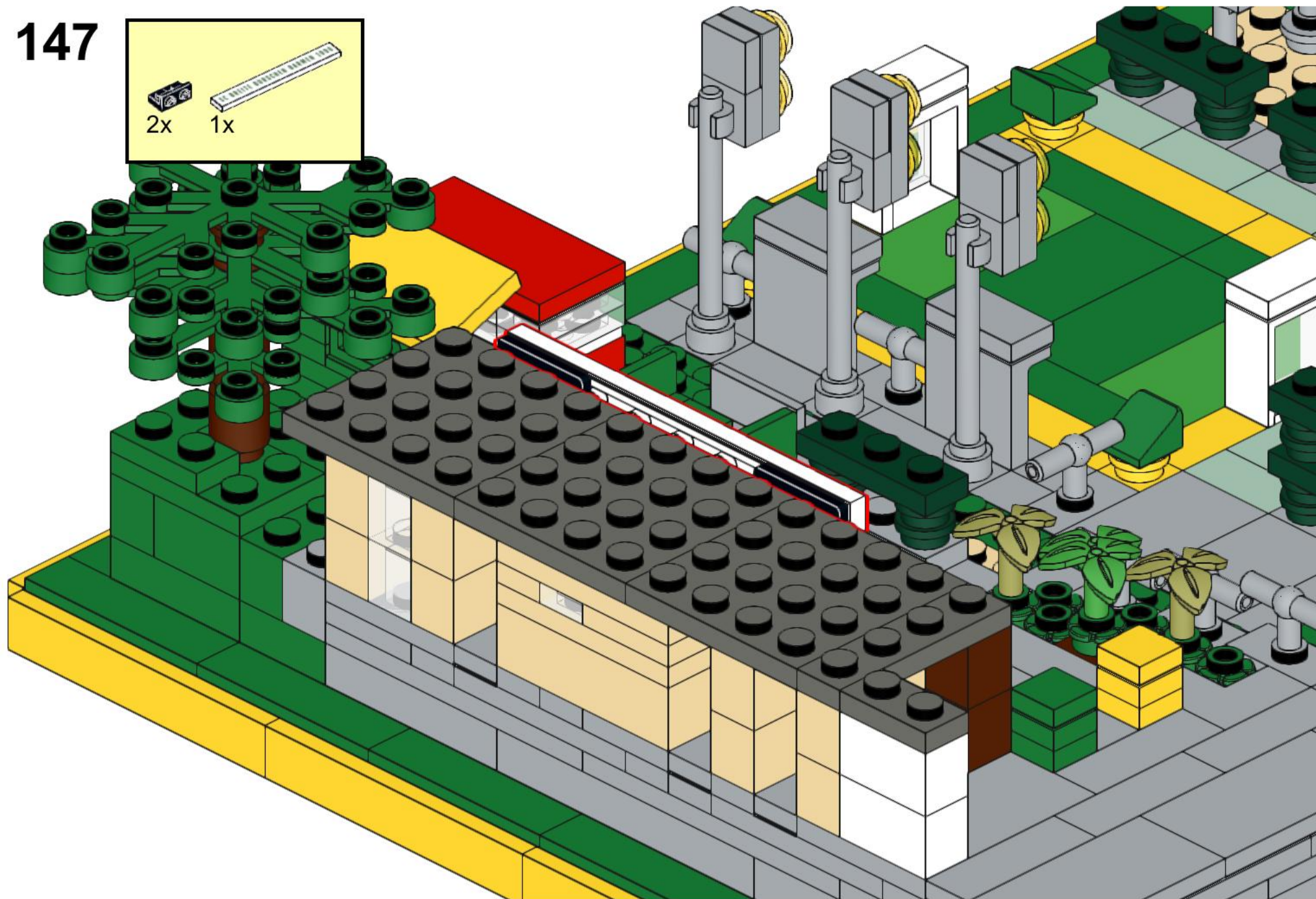
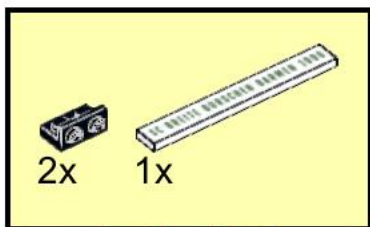

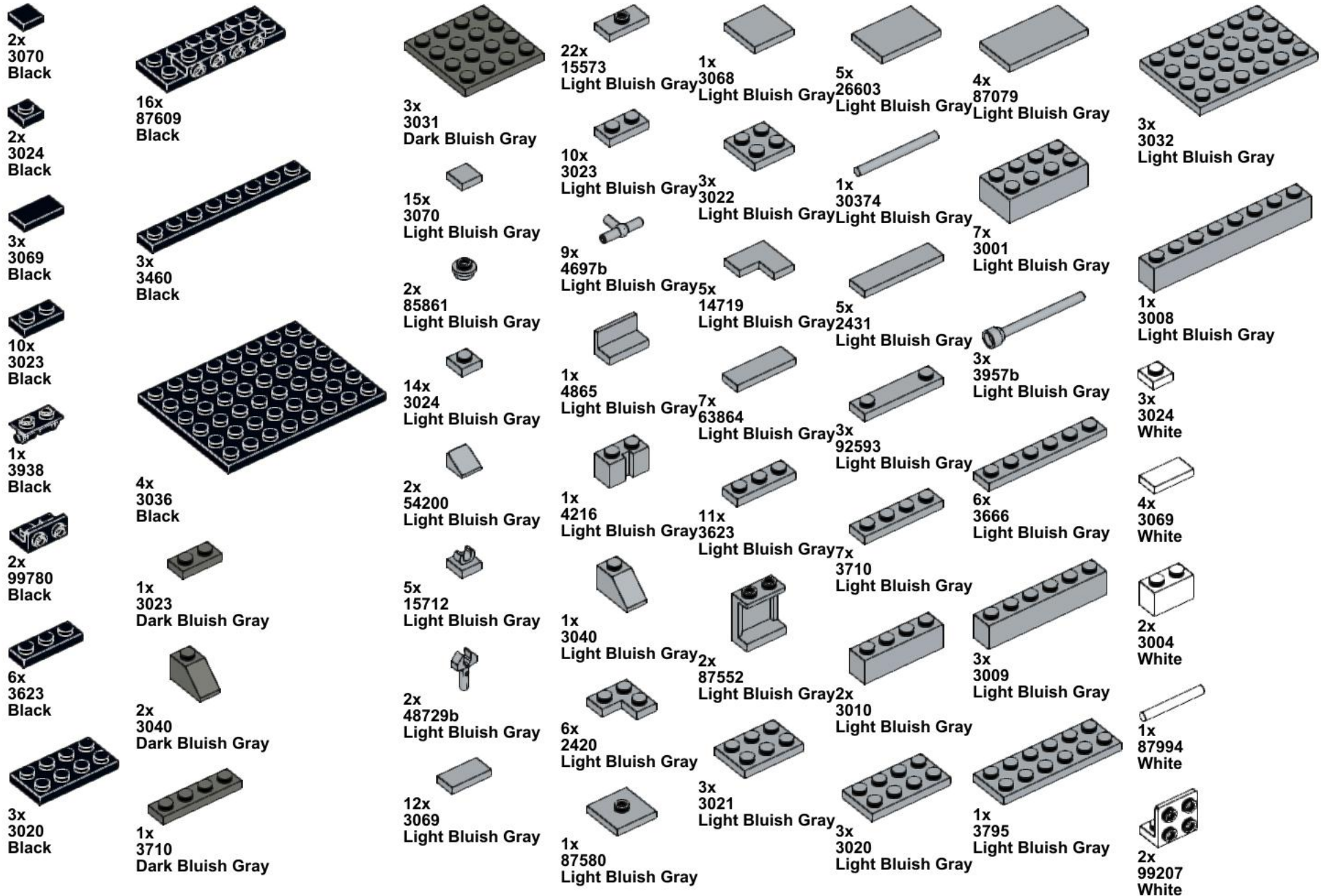



2x
60592
White



1x



3x
3024
Red



1x
3069
Red



2x
4623b
Red



1x
87079
Red



1x
3070
Reddish Brown



6x
3024
Reddish Brown



3x
85861
Reddish Brown



2x
3062
Reddish Brown



1x
4070
Reddish Brown



9x
3005
Reddish Brown



2x
3023
Reddish Brown



1x
2877
Reddish Brown



1x
3022
Reddish Brown



1x
3020
Reddish Brown



1x
3024
Orange



2x
3023
Orange



1x
4070
Reddish Brown



4x
3005
Tan



1x
3023
Tan



4x
4073
Yellow



4x
3004
Tan



1x
3022
Tan



1x
3021
Tan

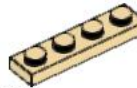

2x
3710
Tan



1x
3010
Tan

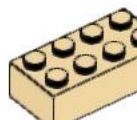

1x
3001
Tan



6x
3070
Yellow



4x
4073
Yellow



11x
3024
Yellow



3x
3023
Yellow



12x
3069
Yellow



2x
63864
Yellow

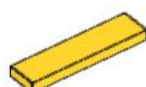

8x
2431
Yellow



1x
87079
Yellow



10x
6636
Yellow



3x
4162
Yellow



2x
37695
Olive Green



1x
2423
Olive Green



40x
85861
Dark Green



3x
3023
Dark Green



2x
3004
Dark Green



5x
3623
Dark Green



6x
3710
Dark Green



1x
3010
Dark Green



6x
3070
Green



15x
24866
Green



11x
3024
Green



8x
54200
Green



1x
3005
Green



6x
3023
Green



6x
3069
Green



3x
4865b
Green



1x
3937
Green



4x
3040
Green



4x
2420
Green



13x
3039
Green



2x
3062
Green



2x
3623
Green



5x
63864
Green



2x
3003
Green

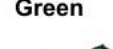

1x
3622
Green

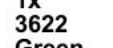

1x
3021
Green



1x
3021
Green



2x
3002
Green



30x
2431
Green

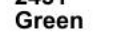

1x
3031
Green

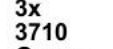

3x
3710
Green



2x
3010
Green



1x
3020
Green



2x
87079
Green



1x
2423
Green



5x
3001
Green



1x
3031
Green



1x
3031
Green



1x
3666
Green



1x
3010
Green



1x
3795
Green

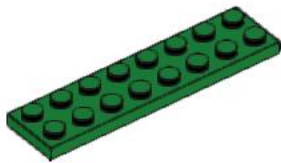

2x
3034
Green



11x
3069
Sand Green



2x
3065
Trans-Clear



5x
3032
Green

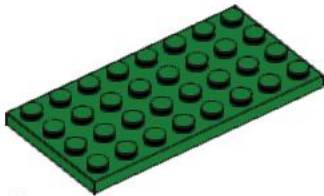

12x
3035
Green



2x
3024
Blue



6x
4073
Trans-Yellow

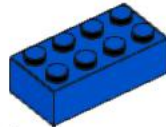

5x
3001
Blue



1x
4073
Metallic Silver



4x
2417
Green



2x
3070
Bright Green



2x
3024
Trans-Clear



2x
3460
Green

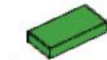

2x
3069
Bright Green



1x
54200
Trans-Clear



2x
37695
Bright Green



5x
3005
Trans-Clear

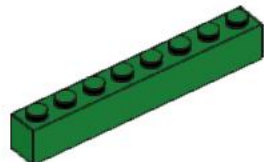

1x
3008
Green

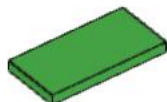

2x
87079
Bright Green



8x
3023
Trans-Clear



1x
3070
Sand Green



2x
60601
Trans-Clear